

Digital display three phase multifunctional LCD instrument

(LCD)An instruction manual

Products Instructions

Thank you for using our digital power meter. Please read this instruction carefully before using the product.

1、an overview

Multifunctional electric power instrument is a kind of multifunctional electric power instrument with the functions of programmable measurement, display, digital communication and power pulse output. It can complete the electric measurement, electric energy measurement, data display, acquisition and transmission. It can be widely used in substation automation, distribution automation, intelligent building, and electric energy measurement in enterprises. Quantity, management and examination. Measuring accuracy is 0.5 level, realizing LED field display and remote RS-485 digital interface communication, using MODBUS-RTU communication protocol.

2、technical parameter

technical parameter		index	
input	network		Three phase three wire (3P3L) 、 Three phase four wire (3P4L)
	Voltage	Rated value	AC110V、 AC220V、 AC380V、 AC600V Other special specifications need to be customized (instructions for ordering)
		Overload	Duration: 1.2 times instantaneous: 2 times /5s
		Powerwaste	Less than 2VA (per phase)
		impedance	>500k Ω
		measurement accuracy	True RMS side (RMS) accuracy 0.2 level.
		Electric current	Rated value
	Overload		Duration: 1.2 times instantaneous: 10 times /5s
	Power waste		Less than 1VA (per phase)
	impedance		<20m Ω
	measurement accuracy		True RMS side (RMS) accuracy 0.2 level.
	frequency		45Hz-65Hz、 accuracy0.1HZ
	Display mode		LCD LCD or LED digital display
output	electric energy	measurement accuracy	Four quadrant metering, active power 1, reactive power 2.
		Pulse output	Active power and reactive power 2 pulse output, optocoupler relay
		Pulse constant	3200
	commu mode	RS485 ModBus-RTU Agreement	

	nication	baud rate	1200bps、2400bps、4800bps、9600bps Default is9600bps
	Switching output		The upper and lower limit alarm outputs the same relay, up to 4.
	Converter output		Current output: DC0-20mA, DC4-20mA, Precision 0.5 level, voltage output: DC0- 5V, 0-10V, precision 0.5.
	Switching input		4 way passive dry contact input mode
Power Supply	Range		AC220V、AC/DC85V-265V、50Hz/60Hz
	Power waste		≤5VA
work environ m 辅助 电 ent	temperature		-10℃-55℃
	humidity		25%RH less than 93%RH humidity, no condensation, no corrosive gas occasion
	Atmospheric pressure		86kPa-106kPa
	Pressure resistance		Input / power >2KV, input / output >2KV, power / output >1KV
	insulation		Input, output and power to the housing >50M

1) Auxiliary power supply: Multifunctional power meters with a general (AC/DC) power input interface, without special declaration, The standard AC220V power supply interface is provided to ensure that the power supply is suitable for this series of products.

To prevent damage to products, special power supply voltage such as AC/DC85V-265V and AC380V can be customized.

Please mark when shipment. Note: when using AC power supply, it is suggested to install 1A fuse on the side of the fire line.

When the quality is poor, it is suggested to install surge suppressor in power circuit to prevent lightning strike and fast pulse group suppressor.

2) Input signal: The multi-function electric power meter adopts the calculation method that each measuring channel collects separately, which ensures the use of the instrument.

It is completely symmetrical and has various wiring modes. Suitable for different load forms. Note: specific wiring and

Instrument parameters (pulse constant, etc.) see the wiring diagram of the instrument. .

3) Voltage Input: The input voltage shall not be higher than the rated input voltage of the product (100V or 400V), if not indicated.

When the factory is AC0~500V and higher than 500V, PT should be considered and 1A fuse should be installed at the voltage input end

4) Current input: Standard rated input current of 5A, greater than 5A, external CT should be used. If CT is used

Connecting other instruments, wiring should be in series, remove the current input products before connecting, must first

Disconnect the CT primary circuit or short circuit two times. It is recommended to use wiring blocks, do not directly connect to CT, so that

they can be disassembled and installed.

5) Make sure that the input voltage and current correspond in the same order and direction; otherwise, the values and symbols of power and energy will be wrong!

The configuration of the instrument input network is determined by the number of CT scans in the system. In the case of two CT scans, three-phase three-wire is selected.

6) Two component mode; in the case of 3 CT, choose three-phase four wire three element mode. Instrument wiring, instrument editing

The input network NET set in the program should be in line with the wiring mode of the load being measured, or it will lead to instrumentation measurements.

The voltage or power is incorrect. In three-phase three wires, the voltage is measured and displayed as line voltage, while in three-phase.

In the four line, the voltage is measured and displayed as the phase voltage of the power network.

3、Programming and usage

3.1 Measurements show that the multi-functional power meters can measure the power parameters in the grid: phase voltage U_a, U_b, U_c ; line voltage U_{ab}, U_{bc}, U_{ca} ; current I_a, I_b, I_c ; total active power P , total reactive power Q , power factor $\cos\theta$, total apparent power S ; frequency HZ and active power, reactive power. All the measurement parameters are stored in the meter's internal power information table, and these data can be accessed and collected through the digital communication interface of the meter. For different types of meters, the display content and mode may not be the same, please refer to specific instructions. The calculation method of all electric parameters is based on the digital discretization method as follows:

公式	备注	公式	备注
$U = \sqrt{\frac{1}{N} \sum_{n=1}^N u_n^2}$	电压有效值	$P_s = UI$	单相视在功率 周期平均值
$I = \sqrt{\frac{1}{N} \sum_{n=1}^N i_n^2}$	电流有效值	$\cos\theta = P_p / P_s$	功率因数
$P_p = \frac{1}{N} \sum_{n=1}^N i_n u_n$	单相有功功率 周期平均值	$P_q = \sqrt{P_s^2 - P_p^2}$	无功功率
$P = \frac{1}{N} \sum_{n=1}^N (i_n u_{an} + i_n u_{bn} + i_n u_{cn})$	总有功功率 周期平均值	$W = \int p dt$	电能

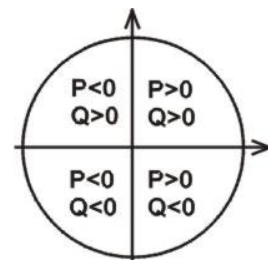

Among them, $P > 0$, the accumulated active energy is the active energy absorption, $P < 0$, the accumulated active energy is the active energy.

Release $Q > 0$, accumulated reactive power is reactive power induction, $Q < 0$, accumulated reactive power is reactive power capacitance.

3.2 panel description

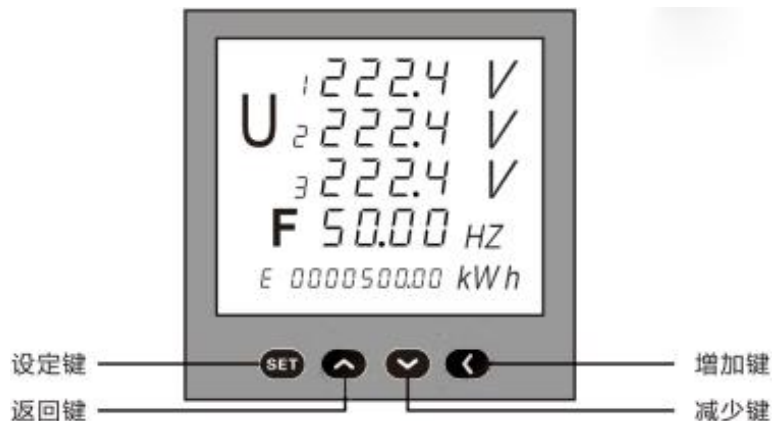

3.3 key function description

Setting key: In the state of measuring and displaying, press this key to enter the programming mode, the instrument prompts to input the password "codE", and after entering the correct password (0001), the instrument can be programmed and set. In programming mode, it is used to confirm selection of menu items and modification of parameter values.

Return key: In programming mode, it is used to return to the superior menu when choosing menu items; the instrument displays parameters in the loop, and can press the return key to fix the display parameters, and then press once again to return to the loop display mode;

Add key: In programming mode, it is used to page down menu items when selecting menu items, to increment parameter values when modifying parameter values, and to page down the display interface when measuring and displaying.

Reduction key: In programming mode, it is used to page up menu items when selecting menu items, to reduce parameter values when modifying parameter values, and to page up the display interface when measuring and displaying.

3.4 显示方式说明

3.4 By programming the "diSP" parameters in the menu, you can choose one of the following 11 display modes. You can also switch the display mode manually by pressing "increase key" or "decrease key" and automatically return to the fixed display mode after 5 seconds. surfacel:

Display mode diSP	Parameter value / corresponding character	Explain
0	3U	The three phase voltage of A, B and C is fixed, and the K lamp indicates KV.
1	3I	Regular display of A, B, C three phase current, K refers to bright KA
2	3P	The three phase active power of A, B and C is fixed, K means KW, M refers to MW
3	3Q	The three phase reactive power of A, B and C is fixed, K means Kvar and M refers to Mvar
4	3S	Fixed display A, B, C three look at power, K means KVA, M refers to MVA

5	F COS	Fixed display of grid frequency and power factor
6	3 COS	Fixed display of A, B and C power factor
7	S P Q	Fixed display total apparent power S, total active power P, total reactive power Q
8	3U	Fixed three phase line voltage Uab, Ubc, Uca
9	d'rdo	Fixed display of DI and DO, second row display switch input DI, third row display switch quantity alarm output DO
10	Automatic switching	Automatic cycle switching displays the above 10 ways.

4、 Menu programming

The organizational structure of the menu is as follows: users can choose the appropriate programming settings according to the actual situation.

First floor	First floor	Third layers	describe
Password (CODE)		Cryptographic data (0~9999)	You can enter programming when the password is correct. Default password: 0001
System setup SET	Display mode disp	Watch table3	Select a fixed display or automatic loop display.
	Electric energy zero CLr.E	YES	After confirmation, the power is cleared
Signal input INP	Network NET	N.3.4 and N.3.3	Select input network nEt N3.3 represents three-phase three wire. N3.4 represents three-phase four wire.
	Voltage range U. SCL	400V and 100V	Measuring range of voltage signals selected
	Current rangeI. SCL	5A and 1A	Selection of measuring range of current signals
	Voltage change ratio PT	1~9999	Setting voltage signal ratio example:10KV/100V=100
	current transformation ratio CT	1~9999	Setting current signal ratioe xample:200A/5A=40
Communication parameters CONN	Address ADDR	1~247	Instrument address range1~247
	baud rate BAUD	1200~9600	baud rate1200、 4800、 9600
Switch output settings	Alarm parameter address 0~54	Reference ratio 0-9999	Please refer to the alarm output instructions for details.

DO-1			
Switch output settings DO-2	Alarm parameter address 0~54	Reference ratio 0-9999	Please refer to the alarm output instructions for details.
Switch output settings DO-3	Alarm parameter address 0~54	Reference ratio 0-9999	Please refer to the alarm output instructions for details.
Switch output settings DO-4	Alarm parameter address 0~54	Reference ratio 0-9999	Please refer to the alarm output instructions for details.
Analog output settings AO-1	Variable parameter address 0~54	Reference ratio 0-9999	Please refer to the alarm output instructions for details.
Analog output settings AO-2	Variable parameter address 0~54	Reference ratio 0-9999	Please refer to the alarm output instructions for details.
Analog output settings AO-3	Variable parameter address 0~54	Reference ratio 0-9999	Please refer to the alarm output instructions for details.
Analog output settings AO-4	Variable parameter address 0~54	Reference ratio 0-9999	Please refer to the alarm output instructions for details.

Usage Requirements: When all instruments are first used, please check the consistency between the parameters of the instrument and the parameters needed in the distribution system. For example, for AC 380V, 200A/5A lines need to be equipped with voltage range AC400V, ER ratio CT = 40 multi-functional power meters. Users can reprogram the meter according to actual needs. The same table for 400A/5A lines. It is only necessary to change the CT ratio to "CT" to 80. In general, the type parameters and factory setting parameters of the instrument are marked in the label behind the instrument.

After the instrument is configured, the meter must be properly connected according to the actual requirements, auxiliary power supply and transmission.

The incoming signal and output signal are carried out according to the instruction manual.

编程菜单结构示意图

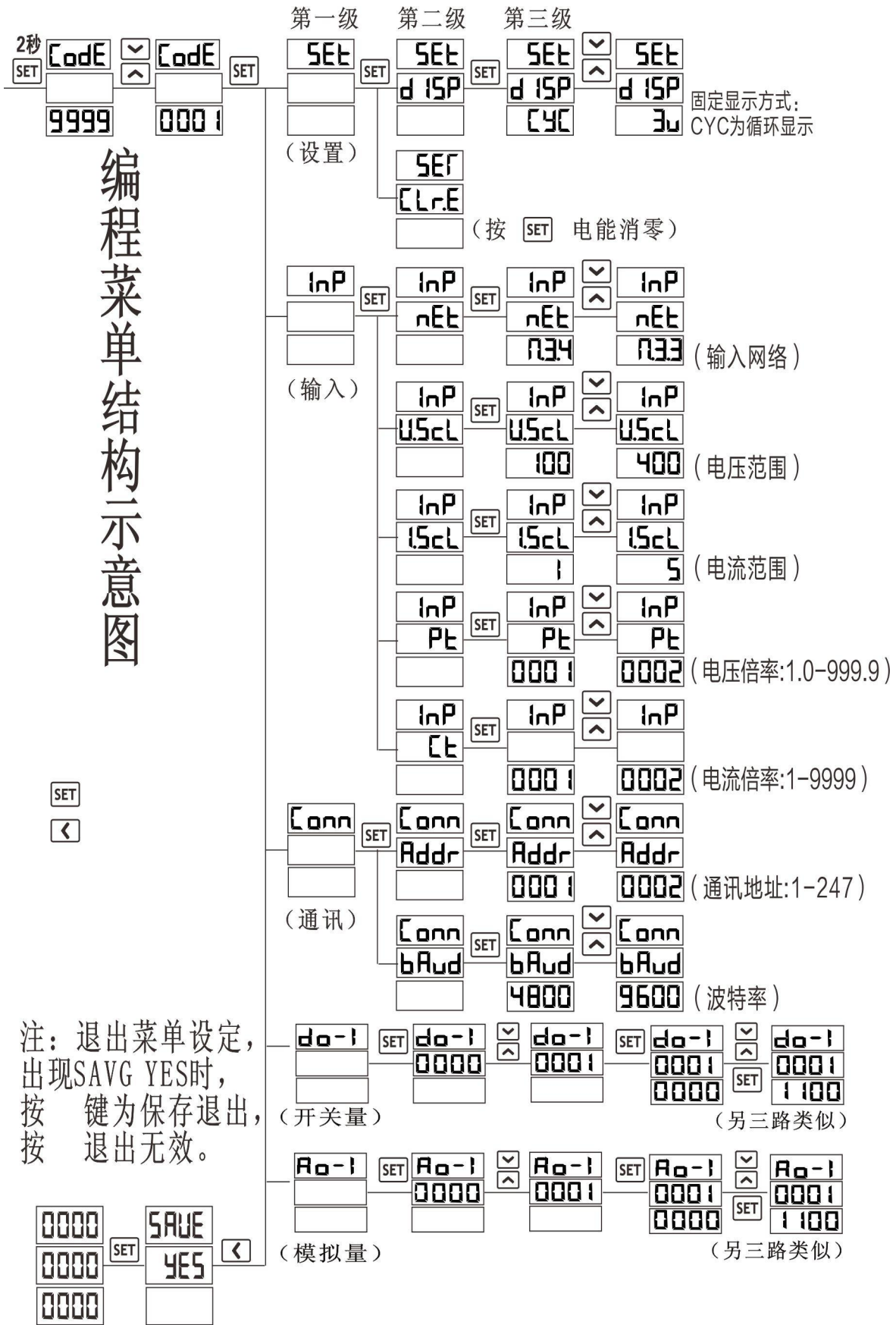

4、Digital communication

Multifunctional power meters provide serial asynchronous half-time RS485 communication interface, using MOD-BUS-RTU protocol, all kinds of data information can be transmitted on the communication line. Up to 247 network power meters can be connected simultaneously on a 485 bus. Each network power meter can set its Address NO. The communication terminal numbers of different series of instruments may be different. The communication connection should use shielded twisted pair with copper network, and the wire diameter should not be less than 0.5mm². When wiring, communication lines should be used to stay away from strong cables or other strong electric field environment. T-type network connection is recommended. Star or other connections are not recommended.

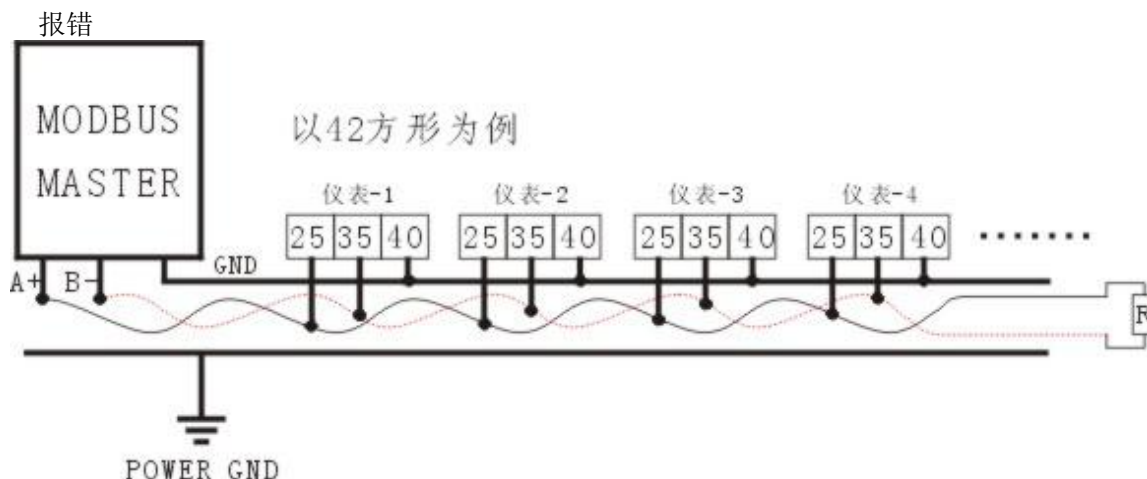

MODBUS/RTU Communication Protocol: The MODBUS protocol uses a master-slave reply communication connection on a communication line. First, the signal of the host computer is addressed to a terminal device (slave) with a unique address, and then the response signal sent by the terminal device is transmitted to the host in the opposite direction, that is, on a single communication line, the signal is transmitted in both directions all the communication data streams (half-duplex mode of operation). MODBUS

The protocol only allows communication between the host (PC, PLC, etc.) and the terminal equipment, but does not allow data exchange between independent terminal equipment, so that the terminal equipment will not occupy the communication line when they initialize, but only respond to the inquiry signal arriving at the local machine.

Host query: query message frame includes device address code, function code, data information code and check code. Address codes indicate what functions the slave device function code to select tells the selected slave device to perform, such as function code 03 or 04 requiring the slave device to read registers and return their contents; data segments contain additional information about the slave device to perform functions, such as in read commands, additional information about data segments is Where does register start?

Number of registers read; check codes are used to verify the correctness of a frame of information, providing a slave device with a way to verify that the message content is correct, using CRC16 calibration rules.

Slave response: If a normal response is generated from the device, there are slave address codes, function codes, data information codes, and CRC 16 check codes in the response message. The data code includes data collected from the device, such as register value or state. If there is any mistake, we will make a response from the machine.

Transport mode refers to a series of independent data structures within a data frame and limited rules for data transmission. The following definitions are compatible with the standard MODBUS-RTU protocol. Bits per byte: 1 start bit, 8 data bits, (parity bit), 1 stop bit (with parity bit) or 2 stop bit (without parity bit). The default data format for communication is: baud rate 9600 pbs, 8 data bits, 1 stop bit, no check (n81), word communication, byte transceiver (byte)

Data frame structure: message format. .

Number address code	Function code	Data code	Check code
1 个 BYTE	1 个 BYTE	N 个 BYTE	2 个 BYTE

Address code at the beginning of the frame, consisting of a byte (8-bit binary code), decimal 0-255, in

our system only use 1-247, other addresses remain. These bits indicate the address of the user-specified terminal device that receives data from the host to which it is connected. The address of each terminal device must be unique. Only the addressed terminal will respond to a query containing that address. When the terminal sends back a response, the slave address data in the response tells the host which terminal is communicating with it.

The function code tells the function of the terminal being addressed. The following table lists the functional codes supported by multi-functional power meters, and their significance and functions. The data code contains the data needed by the terminal to perform a specific function or the data collected when the terminal responds to queries. The contents of these data may be numeric, reference addresses, or set values. For example, a function domain code tells a terminal to read a register, a data domain needs to reflect which register to start with and how much data to read, and slave data code feedbacks contain data length and corresponding data.

The parity check error (CRC) field occupies two bytes and contains a 16 bit binary value. The CRC value is calculated by the transmission device, then attached to the data frame, the receiving device recalculates the CRC value when receiving the data, and then compares it with the value in the received CRC domain. If these two values are not equal, an error occurs.

The process of generating a CRC is:

- 1) preset a 16 bit register to be FFFFH (16 binary, all 1), which is called CRC register.
- 2) The 8-bit XOR operation of the first byte in the data frame with the low byte in the CRC register returns the result to the CRC register.
- 3) The CRC register is shifted to the right one bit, the highest position is filled with 0, the lowest bit is removed and detected.
- 4) If the bit removed in the previous step is 0: repeat the third step (next shift) and 1, the CRC register is XOR with a preset fixed value (0A001H).
- 5) Repeat the third and fourth steps until the 8 shift. This processing has completed a complete eight digit position.
- 6) Repeat second steps to fifth steps to deal with the next eight bits until all byte processing ends.
- 7) Finally, the value of the CRC register is the value of CRC.

Examples of communication messages are:

Read Data (Function Code: 03): This function allows the user to obtain data collected and recorded by the terminal device, as well as system parameters. There is no limit to the number of data requested by the host once, but it can not exceed the defined address range. The following example is to read three data Ia, Ib, and Ic from a slave with a terminal device address of 12 (0CH). Each address in the data frame occupies two words, that is, four bytes, 32 bits. The word address of Ia is also a register address of 15 (0FH), and the data length is 6 (06H).

Query data frame (host)

address	command	Start register Address (high)	Start register Address (low)	Register Number (high position)	Register Number (low)	CRC16 Low position	CRC16 High position
0CH	03H	00H	0FH	00H	06H	F5H	CBH

Response data frame (slave)

address	command	Data length	data1~12	CRC16 Low position	CRC16 High position
0CH	03H	0CH	3FFA511AH, 3FFA511AH, 3FFA36E3H	33H	0FH

It shows: Ia=3FFA511AH (1.9556A), Ib=3FFA511AH (1.9556), Ic=3FFA36E3H (1.9548A).

The response data of instrument slave needs high and low interchangeability (that is, high position at the rear and low position ahead).

本公司的数据结构采用了IEEE754数据结构,在此对IEEE754数据结构做一简介.为便于软件的移植，浮点数的表示格式应该有统一标准(定义)。1985年IEEE (Institute of Electrical and Electronics Engineers) 提出了IEEE754标准。该标准规定基数为2, 阶码E用移码表示，尾数M用原码表示，根据二进制的规格化方法，最高数字位总是1，该标准将这个1缺省存储，使得尾数表示范围比实际存储的多一位。实数的IEEE754标准的浮点数格式为：

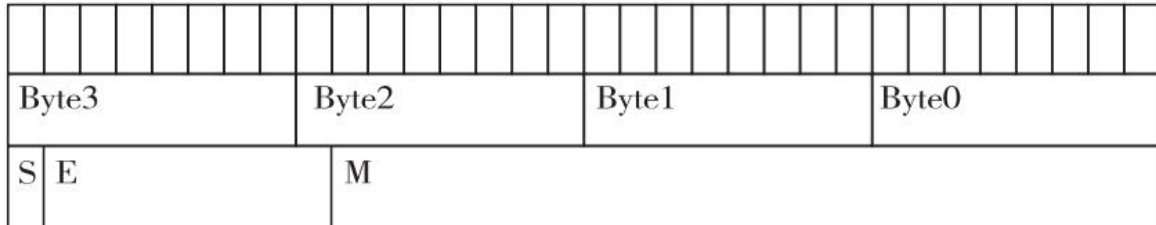

$Value = (-1)^S * 2^{(E-127)} * (1+M)$
 $M = 2^{-1} + 2^{-2} + 2^{-3} + \dots + 2^{-23}$
 例如：0x435C8000

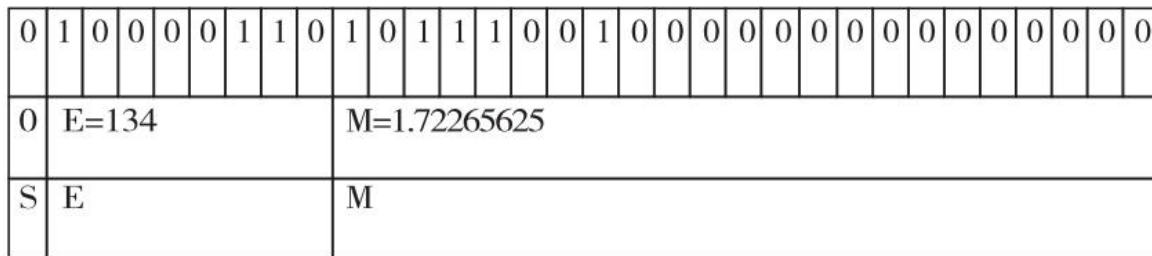

$Value = (-1)^0 * 2^{(134-127)} * 1.72265265$
 $= 1 * 128 * 1.72265265$
 $= 220.5$

如 $Ic=3FFA36E3H=1.9548A$ 是怎么转换来的先把 3FFA36E3H 的 16 进制转换成二进制 0011 1111 1111 1010 0011 0110 1110 0011，再进入网站 <https://www.h-schmidt.net/FloatConverter/IEEE754.html>，是 1 的就打上勾，0 就空格，（或是用网站上的公式算也行）如图

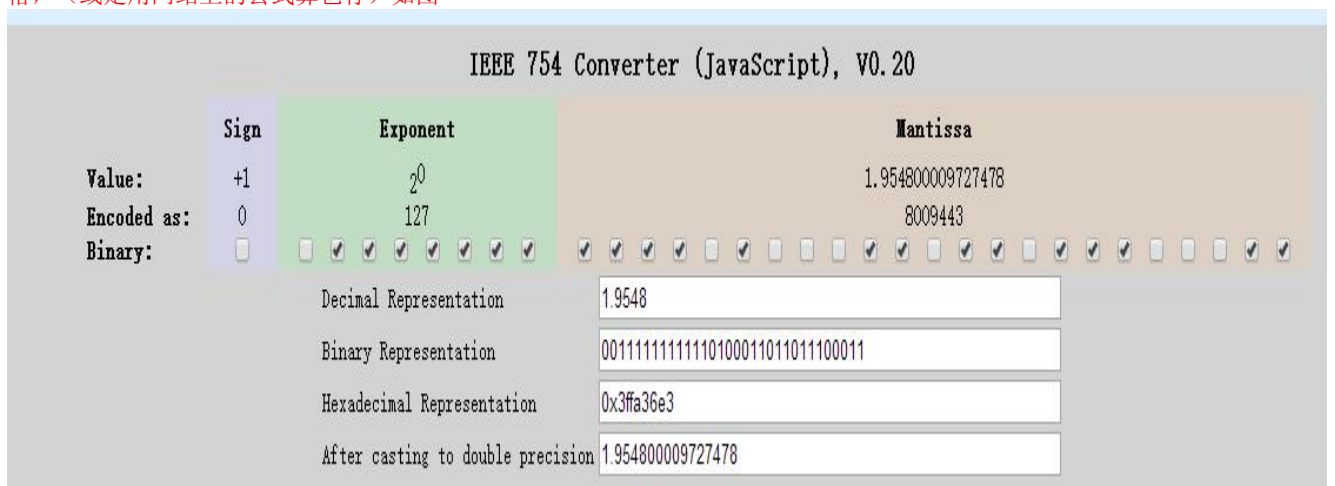

Preset Data (Function Code: 16): This feature allows the user to change the contents of multiple registers (it should be emphasized that the data being written is a writable property parameter). The number of addresses does not exceed the address range. The following example is the write to current ratio of 400A/5A=80 communication.

Preset data frame (host)

address	command	Start register Address (high)	Start register Address (low)	Write in data	CRC16 Low position	CRC16 High position
0CH	10H	00H	07H	00H 50H	71H	F4H

Response data frame (slave) to indicate that data has been written.

address	command	Start register Address (high)	Start register Address (low)	Write in Data (high level)	Write in Data (low)	CRC16 Low position	CRC16 High position
0CH	10H	00H	07H	00H	50H	71H	F4H

MODBUS address information table:

Register address	project	describe	Byte address	Explain
set information				
0	Xs1	Power display selection	0, 1	Power display mode, 0-9 (low byte valid)
1	DZ	Instrument address	2, 3	1-247 (low byte valid)
2	BUAD	baud rate	4, 5	0 for 9600, 1 = 2400 for 4800, 2 (valid for low byte).
3	U. SCL	Voltage range	6, 7	0 for 400V, 1 for 100V (low byte valid).
4	I.scl	Current range	8, 9	0 for 5A, 1 for 1A (low byte valid).
5	net	Network type	10, 11	0 for N.3.3, 1 is N.34 (low byte valid).
6	PT	Voltage ratio	12, 13	PT= voltage 1 times side /2 side (1-9999)
7	CT	Current ratio	14, 15	CT= current 1 times side /2 side (1-9999)
8	STATU S	state	16, 17	Retain

address	project	describe	Byte address	Explain
Electricity information				
9, 10	Ua (three phase four wire)	A phase voltage	18, 19, 20, 21	Floating-point data format, the standard IEEE-754 data format all data are measured once the data contains variable ratio parameters.
11, 12	Ub (three phase four wire)	B phase voltage	22, 23, 24, 25	
13, 14	Uc(three-phase four wire)	C phase voltage	26, 27, 28, 29	
15, 16	Ia	A phase current	30, 31, 32, 33	
17, 18	Ib	B phase current	34, 35, 36, 37	
19, 20	Ic	C phase current	38, 39, 40, 41	
21, 22	Eabc	average current	42, 43, 44, 45	

23, 24	PS	Psum	46、47、48、49
25, 26	QS	Total reactive power	50、51、52、53
27, 28	PFS	Total power factor	54、55、56、57
29, 30	HZ	frequency	58、59、60、61
31, 32	EPP	Positive active energy	62、63、64、65
33, 34	EPN	Negative active electric energy	66、67、68、69
35, 36	EQP	Forward reactive power	70、71、72、73
37, 38	EQN	Negative reactive power	74、75、76、77
39, 40	PA	Active power of A phase	78、79、80、81
41, 42	PB	Active power of B phase	82、83、84、85
43, 44	PC	Active power of C phase	86、87、88、89
45, 46	QA	A reactive power	90、91、92、93
47, 48	QB	B reactive power	94、95、96、97
49, 50	QC	C reactive power	98,99,100,101
51, 52	SA	A looks at power	102,103,104,105
53, 54	SB	B looks at power.	106,107,108,109
55, 56	SC	C looks at power.	110,111,112,113
57, 58	SS	Total apparent power	114,115,116,117
59, 60	PFA	A phase power factor	118,119,120,121
61, 62	PFB	B phase power factor	123,124,125,126

address	project	describe	Byte address	Explain
Power information				
63, 64	PFC	C phase power factor	127,127,129,130	
65, 66	Uab(three-phase three wire)	AB line voltage	131,132,133,134	
67, 68	Ubc(three-phase three wire)	BC phase voltage	135,136,137,138	
69, 70	Uca(three-phase three wire)	CA phase voltage	139,140,141,142	
71, 72	WPP	Positive active energy	143,144,145,146	The two power parameter. The data of IEEE-574 complex points are used to describe the result, unit Wh.
73, 74	WPN	Negative active electric energy	147,148,149,150	
75, 76	WQP	Forward reactive power	151,152,153,154	
77, 78	WQN	Negative reactive power	155,156,157,158	The ratio of X to the two side power data under the input signal should be taken into account

Switch quantity, analog register				
79	D1-DZ	Switch output 1 parameter address	159,160	See output module of switch module.
80	D1-VAL	Switch output 1 reference ratio	161,162	
81	D2-DZ	Switch output 2 parameter address	163,164	
82	D2-VAL	Switch output 2 reference ratio	165,166	
83	D3-DZ	Switch output 3 parameter address	167,168	
84	D3-VAL	Switch output 3 reference ratio	169,170	
85	D4-DZ	Switch output 4 parameter address	171,172	
86	D4-VAL	Switch output 4 reference ratio	173,174	
87	A1-DZ	Analog output 1 parameter address	175,176	See the output of the analog module.
88	A1-VAL	Analog output 1 reference ratio	177,178	
89	A2-DZ	Analog output 2 parameter address	179,180	
90	A2-VAL	Analog output 2 reference ratio	181,182	
91	A3-DZ	Analog output 3 parameter address	183,184	
92	A3-VAL	Analog output 3 reference ratio	185,186	
93	A4-DZ	Analog output 4 parameter address	187,188	

94	A4-VAL	Analog output 4 reference ratio	189,190	
95	DIO	Switching information	191,192	See switch module, low byte effective

Power and power factor information				
96	Pflag	Power symbol bit	193	<p>Bit0-3 : It indicates the direction of active power of A, B, C and phase respectively. 0 is positive and 1 is negative.</p> <p>Bit4-7 : The direction of reactive power is A, B, C and phase respectively. 0 is positive and 1 is negative.</p>
	COSflag	Power factor symbol bit	194	<p>Bit0-3 : It indicates the direction of power factor of A, B, C and phase respectively. 0 is positive and 1 is negative.</p>

set information				
97	MM	Programming password (only readable)	195,196	2byte, 1-9999

Note: IEEE-754 uses a 4-byte binary floating-point number to represent a data power. Its data format and significance are as

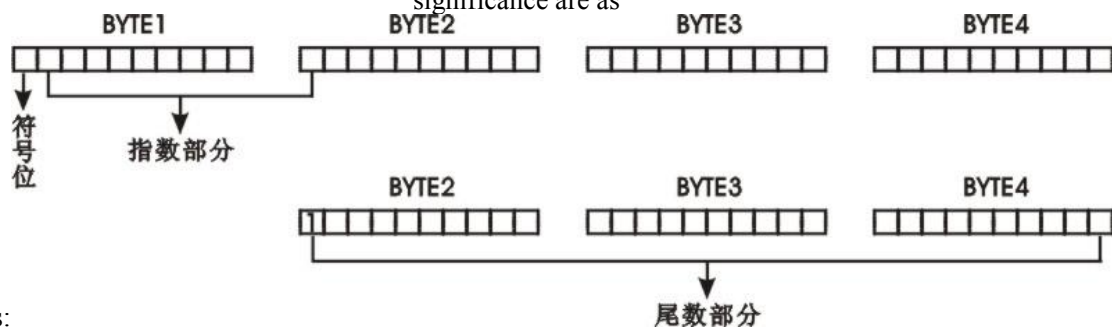

follows:

Sign bit: SIGN=0 is positive and SIGN=1 is negative.

Index part: E= index part -126.

Mantissa part: M='s mantissa part is supplementing the highest level of 1.

Data results: $REAL = SIGN \times 2^E \times M / (256 \times 65536)$

For example, when a host reads the power data, it can be seen from the address table that the power (positive active absorption) address is: (byte mode, compatible with the old standard) 92 (005CH) length is 4 (0004H)

Host: 01H 04H 00 5CH 00 04H 31 DBH

Slave machine: 01 04H 04H 50 80 00 00H EBH 6CH 其中 50 80 00 00 For active power (absorption) data, EBH, 6CH CRC16's low and high position.

Its size: SIGN (Sign bit =0, positive), index EX=A1H-126=35, Tail number: 08 00 00H

Result: 235 X 80.00 00H/100 00 00H=17179869184Wh=17179869kWh.

6、Functional output

1 . Electric energy metering and pulse output: It provides active/reactive power metering, two-way electric energy pulse output function and RS485 digital interface to complete the display and remote transmission of electric energy data. The power pulse (resistance signal) of the collector-level open-circuit optocoupler relay can transmit the active power (forward) and reactive power (backward). The pulse total of the instrument is collected by the remote computer terminal, PLC and DI switch acquisition module to realize the energy accumulation measurement. The output mode or the precision test mode of electric energy (national metrological regulation: pulse error comparison method of standard meter).

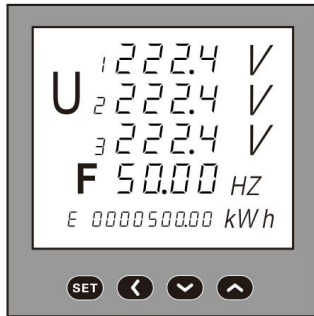

1) Electrical characteristics: collector switch voltage VCC less than 48V, current Iz less than 50mA.

2) Pulse constant: 3200imp/kWh pulse speed is not faster than 200mS. The significance is: when the instrument accumulates 1 kWh, the number of pulse outputs is N (5000, 20000, 80000). It should be emphasized that 1 kWh is the second power data for power. In the case of PT, CT, the relative N pulse data corresponds to 1 kWh * voltage-to-voltage ratio PT * ER ratio CT.

3) Application example: PLC terminal uses pulse counting device, assuming that the number of pulses collected in a period of length t is N, and the input of the instrument is 10kV/100V and 400A/5A, the energy of the instrument accumulates in this period is N/3200*100*80 degree.

The switching module part provides four-way switch input function and four-way optocoupler relay switch output function. Four-way switch input is the use of dry node resistance switch signal input mode, the instrument is equipped with + 12V internal power supply, without external power supply. When the external switch is on, the input module DI collects the switch-on information and displays it as 1. When the external switch is off, the input module DI collects the switch-off information and displays it as 0. The switch input module can not only collect and display the local switch information, but also realize the remote transmission function through the digital interface RS485 of the instrument, that is, the function of "remote communication"; the switch output function of the four-way optocoupler relay can be used for the output function of alarm indication, protection and control in various places. When the switch output is valid, the relay output is turned on, and when the switch output is turned off, the relay output is turned off.

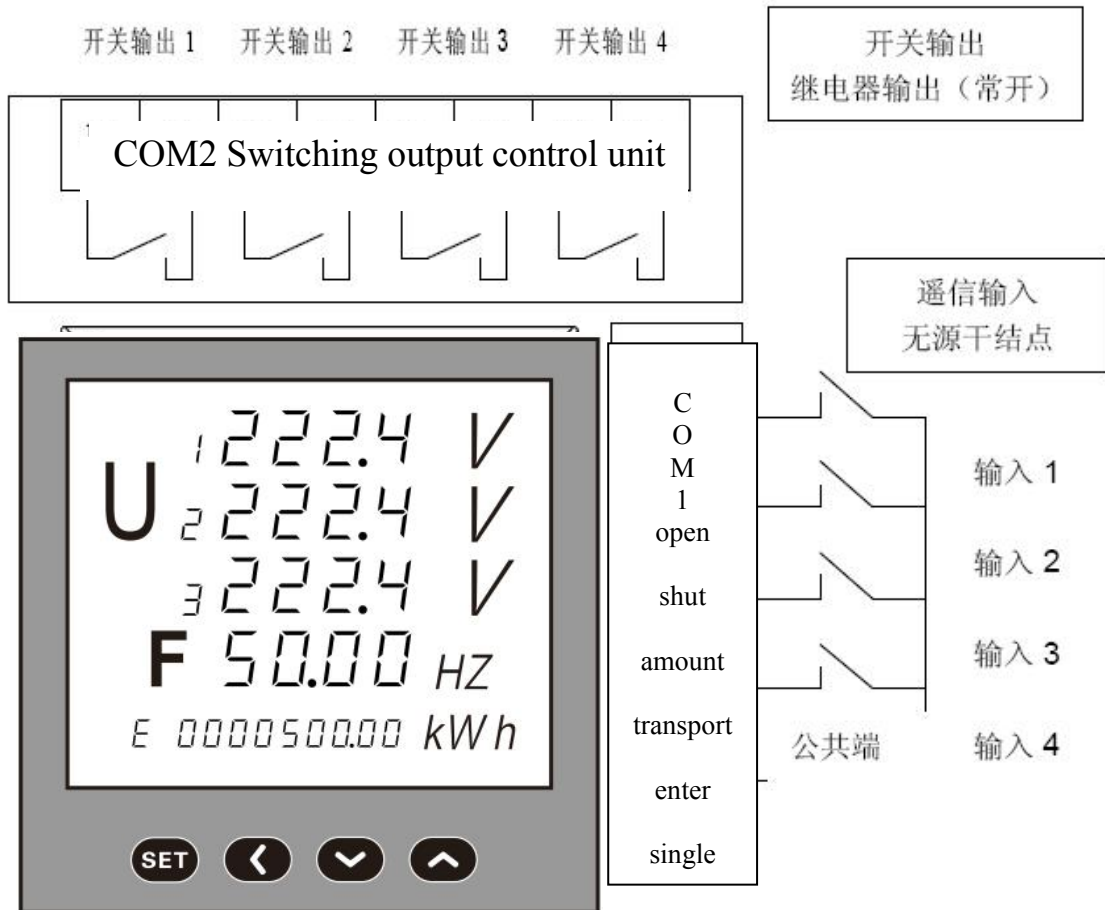

1) .Electrical parameters:

Turn on DI: turn on resistance $R < 500 \text{ ohm}$; turn off resistor $R > 100K \text{ ohm}$.
DO:AC250V 0.1A

2).register:

DIO Information Register (Address 95): The low byte of this register represents the state information of four-way switching input and four-way switching output.

DIO4 bits of information register (BIT7、BIT6、BIT5、BIT4) It is the input state

DIOregister	BIT7	BIT6	BIT5	BIT4	BIT3	BIT2	BIT1	BIT0
Corresponding switch port	Di4	Di3	Di2	Di1	Do4	Do3	Do2	Do1
reset	0	0	0	0	0	0	0	0

information of the switch. asIf the register content is 0101 000, it indicates that the input port of the switch is 3-way, 1-way conduction, 4-way, 2-way turn-off.

DIOThe low 4 bits (BIT3, BIT2, BIT1, BIT0) of the information register are the output state information of the switch. If the register content is 0000 1101, it indicates that port 4, 3, 1 is on, 2 is off, all DIO information can be displayed on the LED of the instrument.

The alarm output parameters of every 1 switches are stored in 2 consecutive addresses, Dx-DZ and Dx-VAL. For example, the low byte of the 2 byte of the first D1-DZ address is used to store the alarm limit address. D1-VAL address 2 bytes storage alarm output object parameters, such as Ua low alarm parameters for 8, high alarm for 7; 0 indicates remote control mode. The two byte of D1-VAL is the alarm limit parameter. The other 3 roads are similar. Corresponding address space can refer to address list.

project	variable	Significance:	variable	Significance
Switch output 1	D1-DZ	(1-255), alarm items, 1-54 singular corresponding to the corresponding energy address meter in the measurement of low alarm; and double corresponding to the high alarm, 0 means remote control. Please refer to the comparison table of switch output and variable output power parameters.	D1-VAL	(1~9999) alarm limit parameter.
Switch output 2	D2-DZ		D2-VAL	
Switch output 3	D3-DZ		D3-VAL	
Switch output 4	D4-DZ		D4-VAL	

3) .Application lifting:

A. Switch input function:

The switch module has four-way switch input acquisition function. After acquiring the input signal, the LED of the instrument panel displays its "on-1" or "off-0" information, which is used for the local monitoring of the Tianguan signal. Switch instrument to switch information display status.

The information of the switch information register (DIO) can be transmitted to the remote computer terminal through the instrument RS485 digital interface.

Switch output function:

Remote control function: write control information to DIO information register by upper computer, control the on and off of four output ports of switch quantity, write 1 corresponding port on, write 0 corresponding port off. For example, the number of 2 binary numbers is 00001011, which means 1, 2, 4 switch output ports are turned on, and 3 channels are disconnected. This function can not be used simultaneously with another alarm output function of the switch output module. To use the remote control function, it is necessary to set the parameters of the power object to 0, that is, to turn off the alarm output function. The second line parameter of the instrument is 0 when the switch output function is set. In the remote control state, the upper right diagram shows that the fourth and the first roads are off, and the third and the second roads are on.

Remote control function: write control information to DIO information register by upper computer, control the on and off of four output ports of switch quantity, write 1 corresponding port on, write 0 corresponding port off. For example, the number of 2 binary numbers is 00001011, which means 1, 2, 4 switch output ports are turned on, and 3 channels are disconnected. This function can not be used simultaneously with another alarm output function of the switch output module. To use the remote control function, it is necessary to set the parameters of the power object to 0, that is, to turn off the alarm output function. The second line parameter of the instrument is 0 when the switch output function is set. In the remote control state, the upper right diagram shows that the fourth and the first roads are off, and the third and the second roads are on.

category	Alarm condition	Dx-DZ		Dx-VAL	
		BYTE1	BYTE0	BYTE1	BYTE0
Switch output 1	Ua>11.00kV	007 (00H 07H)		1100 (04H 4CH)	

Switch output 2	Ia>400.0A	013(00H 0DH)	1000 (03H E8H)
Switch output 3	PFS<0.900	052(00H 34H)	900 (03H 84H)
Switch output 4	F>51.00Hz	053(00H 35H)	1020 (03H FCH)

D0-x can be programmed by keyboard programming. In programming operation, D0-x related parameters. Right: LED 1:D0-1 indicates that the set item is the first switch output; LED 2:0014 is the selected alarm power item, 14:Ia low alarm. 2000 is the interval of alarm. When Ia < 2000, D01 outputs an alarm signal, that is, relay conduction.

Comparison of switching output and variable output power parameters surface2

project	Switching output		Converter output	
	Corresponding parameters (high alarm)	Corresponding parameters (low alarm)	Corresponding parameters (4~20mA)	Corresponding parameters (0~20mA)
Uab (AB phase voltage)	1	2	1	2
Ubc (BC phase voltage)	3	4	3	4
Uca (CA phase voltage)	5	6	5	6
Ua(A line voltage)	7	8	7	8
Ub(B line voltage)	9	10	9	10
Uc(C line voltage)	11	12	11	12
Ia (A phase current)	13	14	13	14
Ib (B phase current)	15	16	15	16
Ic (C phase current)	17	18	17	18
Eabc(average current)	19	20	19	20
Pa (Active power of A phase)	21	22	21	22
Pb (Active power of B phase)	23	24	23	24
Pc (Active power of C phase)	25	26	25	26
Ps (Psum)	27	28	27	28
Qa (A reactive power)	29	30	29	30
Qb (B reactive power)	31	32	31	32
Qc (C reactive power)	33	34	33	34

Qs (Total reactive power)	35	36	35	36
Sa (A looks at power)	37	38	37	38
Sb (B looks at power)	39	40	39	40
Sc (C looks at power.)	41	42	41	42
Ss (Total apparent power)	43	44	43	44
PFa (A phase power factor)	45	46	45	46
PFb (B phase power factor)	47	48	47	48
PFc (C phase power factor)	49	50	49	50
PFS (Total power factor)	51	52	51	52
F (frequency)	53	54	53	54

Instrument display page			
d	I	d	o
0It means that the fourth way switch input is disconnected, and the 1 means fourth switch input closure.	0It means that the third way switch input is disconnected, and the 1 means third switch input closure.	0It means that the second way switch input is disconnected, and the 1 means second switch input closure.	0It means that the first switch input is disconnected, and the 1 means that the first switch input is closed.
0It means that the fourth way switch output is disconnected, the 1 indicates that the fourth switch outputs are closed, and the relay is normally open.	0It means that the third way switch output is disconnected, the 1 indicates that the third switch outputs are closed, and the relay is normally open.	0It means that the second way switch output is disconnected, the 1 indicates that the second switch outputs are closed, and the relay is normally open.	0It means that the first switch output is disconnected, and the 1 indicates that the first switch output is closed, and the relay is normally open.

Alarm parameter calculation method:

The calculation of alarm limit parameters of electric parameters: take the maximum 4-digit effective number of the range value, get a 4-digit integer parameter ratio. The ratio of the alarm value to the range value is equal to the ratio of the set value.

$$\text{Set value} = \frac{\text{Alarm value}}{\text{Range Values}} \times 1000$$

If the instrument is 400V, 800A/5A.

Setting requirements	Alarm condition	Programming settings parameters		range
		Electrical parameters Corresponding parameters	Set value	Range Values
Voltage alarm	Ua > 400V	7	1000	400
	Ua > 430V	7	1075	
	Uc < 80V	12	200	
Current alarm	Ia > 800A	13	1000	800
	Ib < 400A	16	500	
	Ic < 70A	18	87	
Power alarm	Pa > 320kW	21	1000	320K
	Ps > 980kW	27	3062	320K
	Ps < 560kW	28	1750	
Power factor alarm	PFs > 0.9	51	900	1
	PFa > 0.866	45	866	
	PFs < 0.5	52	500	

3 Analog Transmitter Output Module: Provides four channels of analog transducer output function, each channel can choose any of 26 electrical parameters to set, through the instrument itself analog transducer module function, realize the analog transducer output function of electrical parameters (0-20mA/4-20mA), the number of corresponding relations can be set arbitrarily. .

1) .Electrical parameters: output 0 ~ 20mA, 0 ~ 20mA accuracy grade 0.5%.

Overload: 120% effective output, maximum current 24mA, voltage 12V.

Load: Rmax=400Ω

register:

The output parameters of each 1 routes are stored using Ax-DZ, Ax-VAL and 2 consecutive addresses. For example, the low byte of the 2 byte of the first A1-DZ address is used to store the alarm limit address. The 2 bytes of A1-VAL address store the parameters of the alarm output object, such as Ua's 0-20mA and D1-VAL's 8, 4-20mA and 20mA. The other 3 roads are similar. Corresponding address space can refer to address list.

AO-X control word can be set by computer and instrument programming keyboard to realize the setting of four analog transmission outputs, including the selection of power items to be transmitted and the corresponding power parameters of full-range 20mA output. .

project	variable	Significance:	variable	Significance
Variable output 1	A1-DZ	(1 ~ 255) , For alarm items, the singular number in 1-54 corresponds to the corresponding measurement of 4-20 mA transmission in the power address table, while the double number corresponds to the corresponding 0-20 mA transmission, please refer to the switch output, transmission output power parameters comparison table.	A1-VAL	(1 ~ 9999) , 20mAOutput, corresponding parameter values.
Variable output 2	A2-DZ		A2-VAL	
Variable output3	A3-DZ		A3-VAL	
Variable output4	A4-DZ		A4-VAL	

Examples of application: for 10KV/100V; 400A/5A meters, A01-Ua: 0-10kV/4-20mA; A02-Ia: 0-400A/4-20mA; A03-P: 0-12MW/0-20mA; A04-Q: 0-12Mvar/0-20mA.

category	Converter output	Ax-DZ		Ax-VAL	
		BYTE1	BYTE0	BYTE1	BYTE0
Converter output1	Ua:4-20mA	007(00H 07H)		1100 (04H 4CH)	
Converter output2	Ia:4-20mA	013(00H 0DH)		1000 (03H E8H)	
Converter output3	PS:0-20mA	028(00H 1CH)		3000 (0BH B8H)	
Converter output4	QS:0-20mA	036(00H 24H)		3000 (0BH B8H)	

Computation of the output parameter value of the electric parameter transducer: Take the highest significant number of the range value and get a bit-integer reference value. Then the ratio of the transducer value to the range value is equal to the ratio of the set value to the reference value. (The transducer value should not be lower than the range value.)

$$\text{Set value} = \frac{\text{Change value}}{\text{Range Values}} \times 1000$$

If the instrument is 400V 800/5A

Setting requirements	Change condition	Programming settings parameters		Range Values
		Electrical parameter corresponding parameters	Set value	
Voltage transfer	Ua:0-400V/4-20mA	7	1000	400
	Ub:0-420V/4-20mA	9	1050	
	Uc:0-350V/0-20mA	12	875	
Electrorheological	Ia:0-800A/0-20mA	14	1000	800
	Ia:0-800A/4-20mA	13	1000	

transmission	Ib:0-900A/4-20mA	15	1125	
Power	Pa:0-320kW/0-20mA	22	1000	320K
transmission	Ps:0-960kW/4-20mA	27	3000	
Power factor	Pfa:0-1/0-20mA	28	1000	1
conversion	PFs:0-0.9/4-20mA	51	900	

Transmitter output settings parameter AOSi (3BYTE) can be set by keyboard programming. In the programming operation, the A0-x menu item is the setting parameters of the parameters of the transducer module. In the following setting parameters, A0-1: Transmitter output circuit 1; 007: Select the power item Ua for 4-20mA, and the voltage corresponding to 20mA is 1.000, for example, in a 10kV/100V network, is accomplished: the transducer output loop 1:Ua:0-10kV/4-20mA.

5、Instrument wiring mode

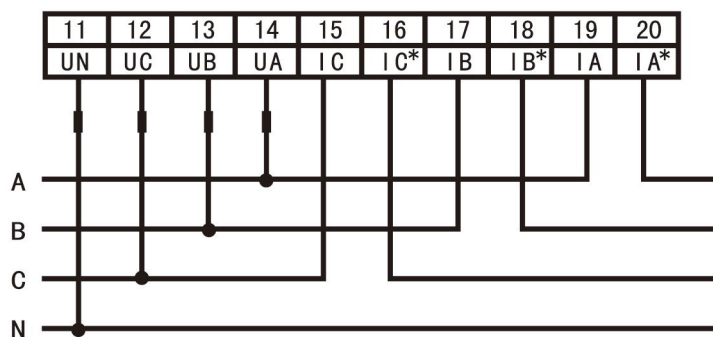

电压直接接入、电流直接接入

The three-phase four wire voltage is less than 500V and the current is less than 5A.

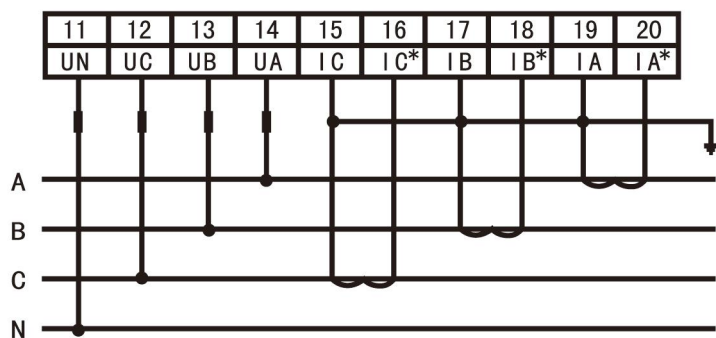

电压直接接入、电流经互感器接入

The three-phase four wire voltage is less than 500V and the current is greater than 5A.

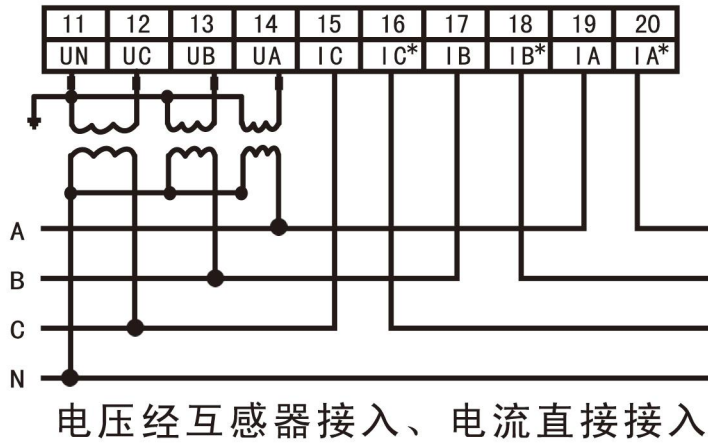

The three-phase four wire voltage is higher than 500V, and the current is less than 5A.

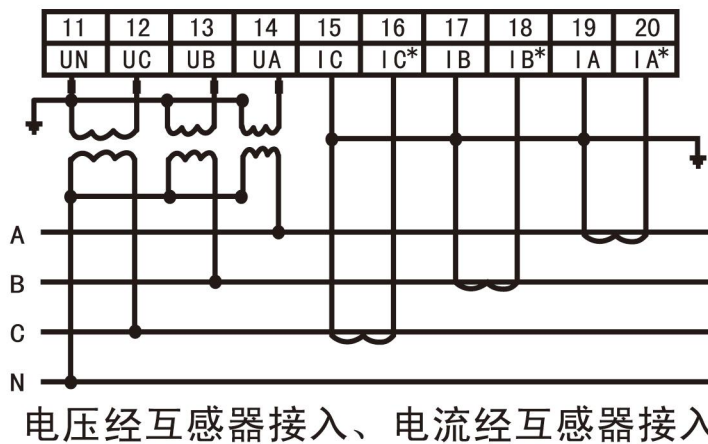

The three-phase four wire voltage is higher than 500V and the current is greater than 5A.

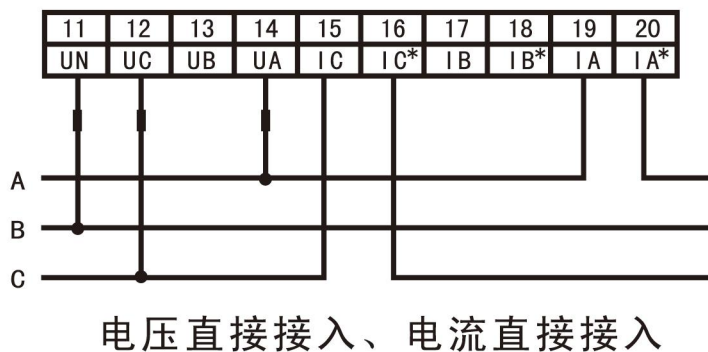

The three-phase three wire voltage is less than 500V and the current is less than 5A.

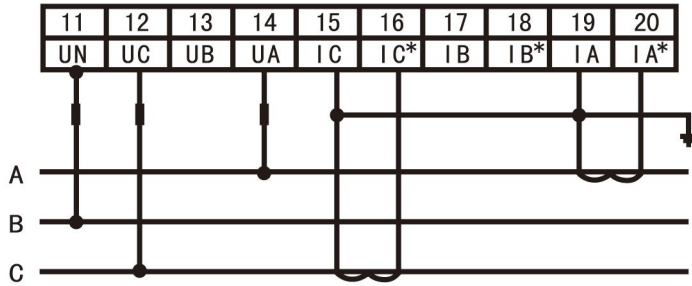

电压直接接入、电流经互感器接入

The three-phase three wire voltage is less than 500V and the current is greater than 5A.

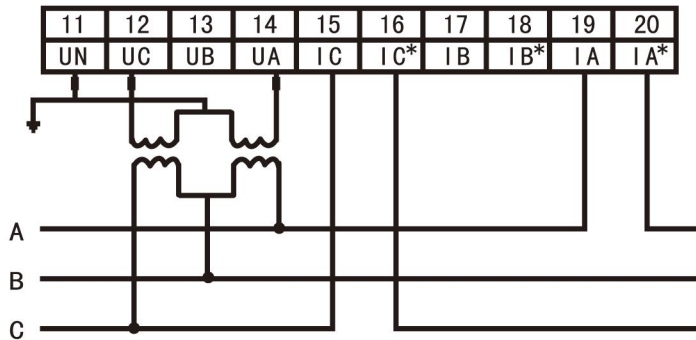

电压经互感器接入、电流直接接入

The three-phase three wire voltage is higher than 500V, and the current is less than 5A.

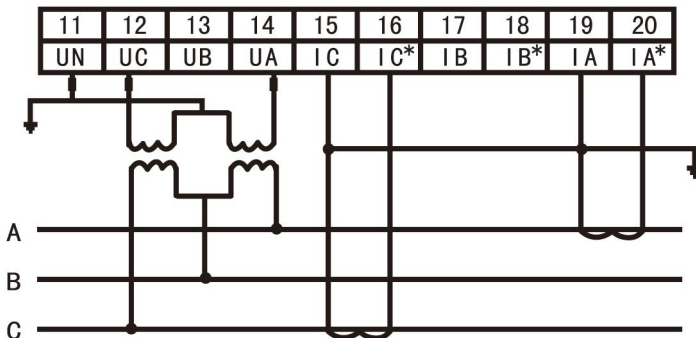

电压经互感器接入、电流经互感器接入

The three-phase three wire voltage is higher than 500V and the current is greater than 5A.



工作电源

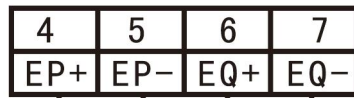

脉冲输出

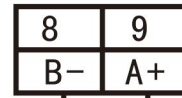

RS485通信



开关量输入

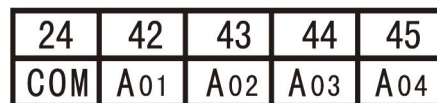

模拟量输出



开关量输入

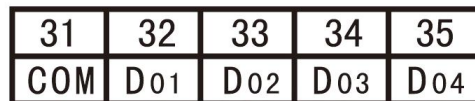

开关量输出

96*96 尺寸后面端子示意图

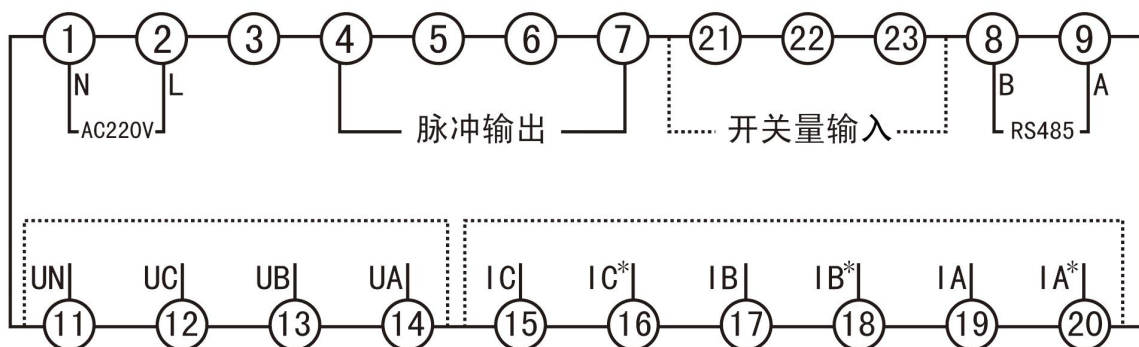

6、 Common setup problems

1.Set current to speed ratio

Press SET button for 5 seconds, the first row of the instrument shows COdE, the second row does not show, the third row shows 9999, at this time, press the up key 2 down, the instrument shows COdE in the first row, the second row does not show, the third row shows 0001, at this time, press SET key, the instrument shows SEt in the first row, the second row does not show, the third row does not show, at this time, press Up key, the first row of the instrument is displayed as Inp, the second row is not displayed, the third row is not displayed, at this time, press SET key, the first row of the instrument shows Inp, the second row shows nEt, the third row does not show, at this time, press down key, the instrument shows Inp in the first row, the second row shows Ct, the third row does not show, at this time, again press SET Well, the first row shows Inp, the second row shows Ct, the third row shows 1, then press the up or down key to set the current transformer ratio, such as 100/5A transformer is 100 divided by 5 equals 20, set him to 20, 600/5A transformer is 600 divided by 5 equals 120, set him to 120, after you set it, you press again Left key, the third row of the instrument is no longer displayed, and then press the left key, the second row of the instrument is no longer displayed, and then press the left key, the instrument shows SRUg in the first row, the second row shows YES, at this time again press SET Jian, the instrument is set to complete the ratio.

2.Setting instrument display mode

The default diSP value of the instrument factory is 10, that is, automatic circulation display mode, if you want to set the current fixed display mode, see Table 1, diSP value is 1,

Press SET button for 5 seconds, the first row of the instrument shows COdE, the second row does not show, the third row shows 9999, at this time, press the up key 2 down, the instrument shows COdE in the first row, the second row does not show, the third row shows 0001, at this time, press SET key, the instrument shows SEt in the first row, the second row does not show, the third row does not show, at this time, press SET key, the first row of the instrument shows SEt, the second row shows diSP, the third row does not show, at this time, press SET key, at this time, the first row shows SEt, the second row shows diSP, the third row shows 10, at this time, press the down key, change to 1, after setting, you press the left key again, the third row of the instrument no longer shows, and then press the direction Left key, the second row of the instrument is no longer displayed, and then press the left key, the instrument shows SRUg in the first row, the second row shows YES, at this time again press SET Jian, the instrument set to complete the ratio.

3.Setting instrument network format

The network format of the instrument is three-phase four wire system, n.34.

Press SET button for 5 seconds, the first row of the instrument shows COdE, the second row does not show, the third row shows 9999, at this time, press the up key 2 down, the instrument shows COdE in the first row, the second row does not show, the third row shows 0001, at this time, press SET key, the instrument shows SEt in the first row, the second row does not show, the third row does not show, at this time, press Up key, the first row of the instrument is displayed as Inp, the second row is not displayed, the third row is not displayed. At this time, press SET key, the first row of the instrument shows Inp, the second row shows nEt, the third row does not show, at this time press SET key, the first row of the instrument shows Inp, the second row shows nEt, the third row shows n.34, at this time, press the direction. Up the key, the first row of the instrument shows Inp, the second row shows nEt, the third row shows n.33, after three-phase three-wire system is set up, you press the left key again, the third row of the instrument no longer shows, and then press the left key, the second row of the instrument no longer shows, and then press the left key, the first row of the instrument shows SRUg, the second row shows YES, At this point, click SET Jian again.

4.Changing instrument address

The Rddr value of the instrument is 1.

Press the SET button for 5 seconds, the first row of the instrument shows COdE, the second row does not show, the third row shows 9999, at this time, press the up button 2 down, the instrument shows COdE in the first row, the second row does not show, the third row shows 0001, at this time, press the SET button,

the instrument shows SEt in the first row, the second row does not show, the third row does not show, at this time, press two Up key, the first row of the instrument shows Conn, the second row does not show, the third row does not show, at this time, press SET key, the instrument shows Conn in the first row, the second row shows Rddr, the third row does not show, at this time, press SET key again, the instrument shows Conn in the first row, the second row shows Rddr, the third row shows 001, at this time press up key Or down the key to adjust the table number, such as 120, after you set it, you press the left button again, the third row of the instrument no longer shows, and then press the left button, the second row of the instrument no longer shows, and then press the left button, the instrument shows SRUg in the first row, the second row shows YES, at this time again press SET Jian, instrument communication address 120 set up. become

5.Modify the instrument's screen saver and let meter Chang Liang.

Press SET button for 5 seconds, the first row of the instrument shows COdE, the second row does not show, the third row shows 9999, at this time, press the up key 2 down, the instrument shows COdE in the first row, the second row does not show, the third row shows 0001, at this time, press SET key, the instrument shows SEt in the first row, the second row does not show, the third row does not show, at this time, press SET key, the first row of the instrument shows SEt, the second row shows diSP, the third row does not show, at this time, press the down key, the instrument shows SEt in the first row, the second row shows L-bL, the third row does not show, at this time, again press SET key, the instrument shows SEt in the first row, the second row shows L-bL, the third row shows OFF, at this time, and then press one Press the up button, the instrument shows SEt in the first row, L-bL in the second row, On in the third row. After setting up, you press the left button again, the instrument no longer shows in the third row, and then press the left button, the instrument no longer shows in the second row, and then press the left button, the instrument shows SRUg in the first row, YES in the second row, then press one Under SET Jian, the instrument is set to be always bright.

6.Relay switch quantity alarm setting

1.For example, the instrument transformer is 200/5A, set the first alarm, and the A phase current is higher than 120A alarm.

Press the SET button for 5 seconds, the first row of the instrument shows COdE, the second row does not show, the third row shows 9999, at this time, press the up button 2 down, the instrument shows COdE in the first row, the second row does not show, the third row shows 0001, at this time, press the SET button, the instrument shows SEt in the first row, the second row does not show, the third row does not show, at this time, press three times Up-key, the first row of the instrument shows do-1, the second row does not show, the third row does not show, at this time, press SET key, the instrument shows DO-1 in the first row, 2000 in the second row, the third row does not show, at this time to view (switch output, transfer output power parameters contrast table 2), A phase current high alarm value is 13, and then press up key. Change 1000 to 013. At this time, the first row displays do-1, the second row displays 013, the third row does not show. At this time, press SET key again, the first row displays do-1, the second row shows 013, the third row shows 0000. (About the setting of alarm value, 120 divided by 200 and 1000 = 600) Press the up button to change 0000 to 0600, at this time The instrument displays DO-1 in the first row, 013 in the second row, 0600 in the third row. After setting, you press the left button again, the third row of the instrument is no longer displayed, and then press the left button, the second row of the instrument is no longer displayed, and then press the left button, the instrument shows SRUg in the first row, the second row shows YES, and then press SET Jian. Instrument alarm settings completed

2.Set up third way alarm, C phase voltage Uc below 100V alarm,

Press the SET button for 5 seconds, the first row of the instrument shows COdE, the second row does not show, the third row shows 9999, at this time, press the up key 2 down, the first row of the instrument shows COdE, the second row does not show, the third row shows 0001, at this time, press the SET button, the first row of the instrument shows SEt, the second row does not show, the third row does not show, at this time, press five Up key, the first row of the instrument display do-3, the second row is not displayed, the third row is not displayed, at this time, press SET key, the instrument display do-3 in the first row, 2000 in the second row, the third row is not displayed, at this time to view (switch output, transfer output power parameters contrast table 2), C phase voltage low alarm value is 12, and then press up key. Change 1000 to 012. At this time, the first row displays do-3, the second row displays 012, and the third row does not. At this time, press SET again. The first row displays do-1, the second row displays 012, and the third row displays 0000. (About the setting of alarm value, 100 divided by 231 and then 1000 = 433, note that the

phase voltage alarm value is divided by 231 Press the up button to change 0000 to 0433. At this time, the meter displays do-3 in the first row, 012 in the second row and 0433 in the third row. After setting up, you press the left button again. The third row of the meter is no longer displayed. Press the left button again, and the second row of the meter is no longer displayed. The first row of the meter shows SRUg, and the second row shows YES. At this time, click SET Jian, and the alarm setting is finished.

7、 For example, current transformer 100/5A, B phase current 0-80A corresponding to analog quantitative transmission 4-20m first transmission.

Press the SET button for 5 seconds, the first row of the instrument shows COdE, the second row does not show, the third row shows 9999, at this time, press the up key 2 down, the first row of the instrument shows COdE, the second row does not show, the third row shows 0001, at this time, press the SET button, the first row of the instrument shows SEt, the second row does not show, the third row does not show, at this time, press seven Up key, the first row of the instrument shows Ro-1, the second row does not show, the third row does not show, at this time, press SET button, the instrument shows Ro-1 in the first row, the second row shows 000, the third row does not show, at this time to view (switch output, transfer output power parameters contrast table 2), B phase current corresponding to 4-20 mA output value is 15, and then press Up key, change 1000 to 015, at this time the first row of the instrument shows Ro-1, the second row shows 015, the third row does not show, at this time, press SET key, the instrument shows Ro-1 in the first row, the second row shows 015, the third row shows 0000, (about the setting of the value of ER, 80 divided by 100 again obedient $1000 = 800$) press up key to change 0000 to At 0800, the first row of the instrument shows Ro-1, the second row shows 015, the third row shows 0800, after setting, you press the left key again, the third row of the instrument no longer shows, and then press the left key, the second row of the instrument no longer shows, and then press the left key, the first row of the instrument shows SRUg, the second row shows YES, and then press one again. Next SET kin, instrument switch setup complete.

8、 if B phase voltage Ub is set, third circuit is sent to 0-300V and analog output is sent to 0-20mA output.

Press the SET button for 5 seconds, the first row of the instrument shows COdE, the second row does not show, the third row shows 9999, at this time, press the up key 2 down, the first row of the instrument shows COdE, the second row does not show, the third row shows 0001, at this time, press the SET button, the instrument shows SEt in the first row, the second row does not show, the third row does not show, at this time, press nine Up key, the first row of the instrument shows Ro-3, the second row does not show, the third row does not show, at this time, press SET button, the instrument shows Ro-3 in the first row, the second row shows 000, the third row does not show, at this time to view (switch output, transfer output power parameters contrast table 2), B phase voltage Ub corresponding to 0-20 mA output value is 10, then press Up key, change 1000 to 010. At this time, the first row of the meter shows Ro-3, the second row shows 010, the third row does not show. At this time, press SET key again, the first row of the meter shows Ro-3, the second row shows 010, the third row shows 0000. (About the setting of voltage transfer value, 300 divided by 400 and $1000 = 750$) Press the up key to change 0000. At 0750, the first row of the instrument shows Ro-3, the second row shows 010, the third row shows 0750. After setting, you press the left key again, the third row of the instrument no longer shows, and then press the left key, the second row of the instrument no longer shows, and then press the left key, the instrument shows SRUg in the first row, the second row shows YES, then press SET Jian, instrument switch setup complete.