

A 0041

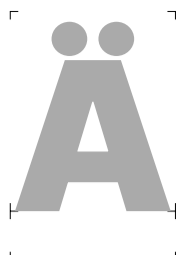

Adieresis 00C4

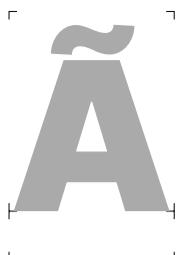

Atilde 00C3

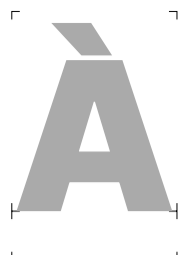

Agrave 00C0



Aacute 00C1



Acircumflex 00C2

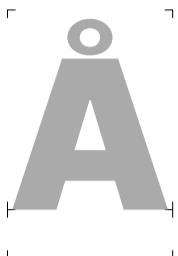

Aring 00C5

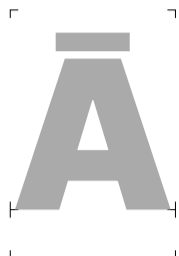

Amacron 0100

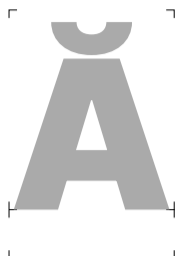

Abreve 0102

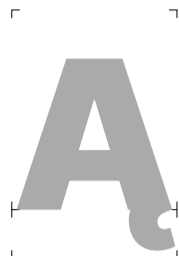

Aogonek 0104



Acaron 01CD

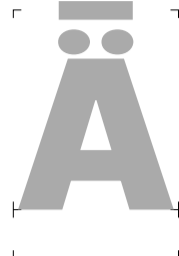

Adieresismacron 01DE



Adotmacron 01E0



Aringacute 01FA



Abogonek 0200



Ainvertedbreve 0202



uni0226 0226



Aringbelow 1E00



Adotbelow 1EA0



Ahookabove 1EA2



Acircumflexacute 1EA4



Acircumflexgrave 1EA6



Acircumflexhookabove 1EA8



Acircumflextilde 1EAA



Acircumflexdotbelow 1EAC



Abreveacute 1EAE



Abrevegrave 1EB0



Abrevehookabove 1EB2



Abrevetilde 1EB4



Abrevedotbelow 1EB6

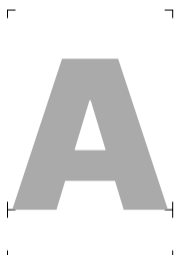

Alpha 0391



Alphanos 0386



uni1F08 1F08



uni1F09 1F09



uni1F0A 1F0A



uni1F0B 1F0B



uni1F0C 1F0C



uni1F0D 1F0D



uni1F0E 1F0E



uni1F0F 1F0F



uni1F88 1F88



uni1F89 1F89

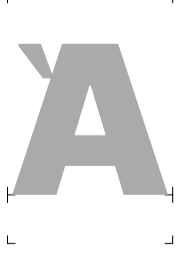

uni1F8A 1F8A

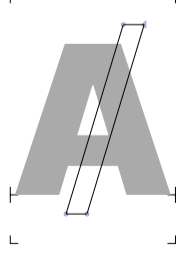

uni023A 023A



uni1F8B 1F8B

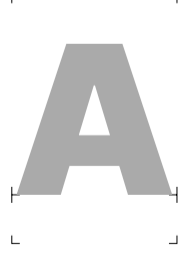

afii10017 0410



Abrevecyrillic 04D0



Adieresiscyrillic 04D2

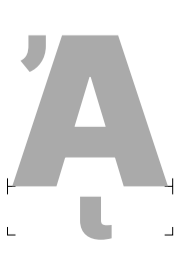

uni1F88 1F88

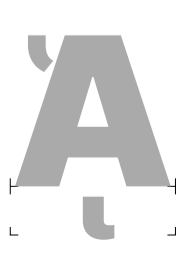

uni1F89 1F89



uni1F8A 1F8A



uni1F8B 1F8B



uni1F8C 1F8C



uni1F8D 1F8D

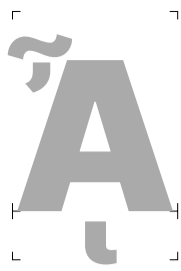

uni1F8E 1F8E



uni1F8F 1F8F



uni1FBC 1FBC

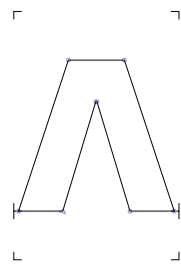

Lambda 039B

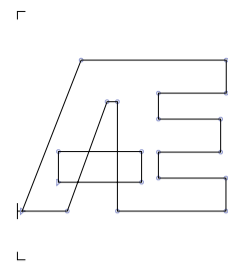

AE 00C6



AEmacron 01E2

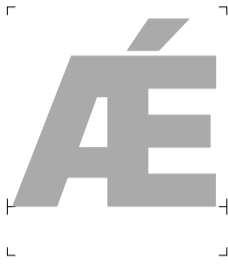

AEacute 01FC

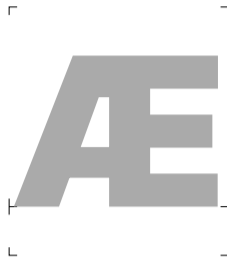

Aiecyrillic 04D4

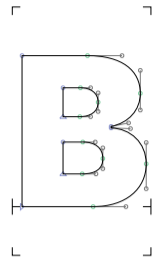

B 0042



Bdotaccent 1E02



Bdotbelow 1E04



Blinebelow 1E06



uni0243 0243

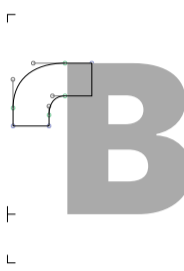

Bhook 0181

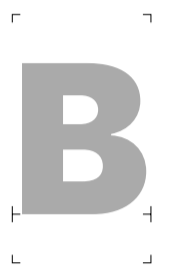

afii10019 0412



Beta 0392

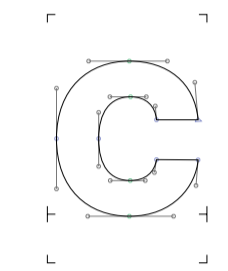

C 0043

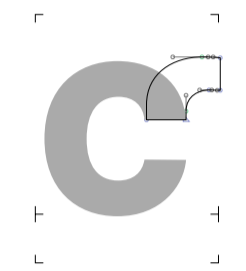

Chook 0187



Ccedilla 00C7

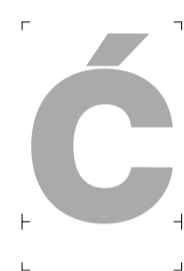

Cacute 0106



Ccircumflex 0108

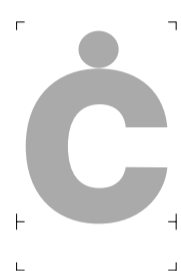

Cdotaccent 010A

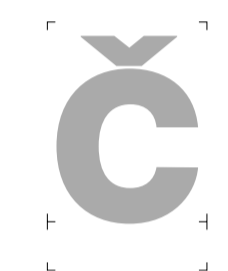

Ccaron 010C

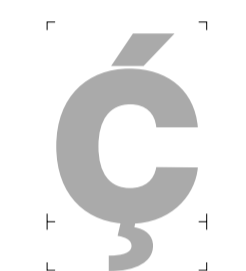

Ccedillaacute 1E08

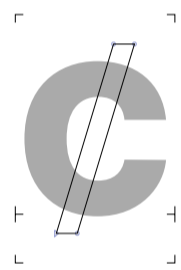

uni023B 023B

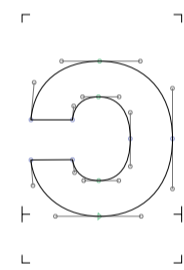

Oopen 0186



uni03F9 03F9

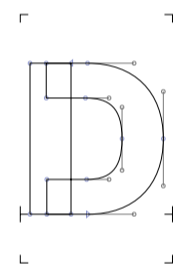

D 0044

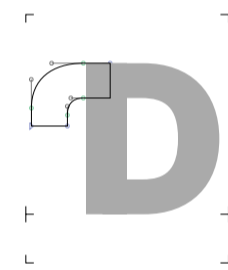

Dhook 018A

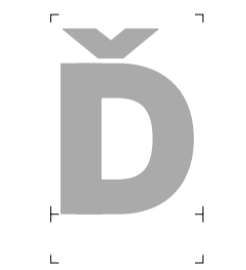

Dcaron 010E



Ddotaccent 1E0A



Ddotbelow 1E0C



Dlinebelow 1E0E

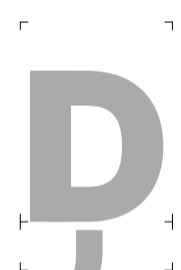

Dcedilla 1E10

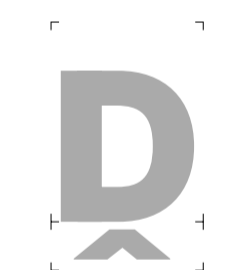

Dcircumflexbelow 1E12



Dbar1 0189



Dz 01F2



Dzcaron_ 01C5

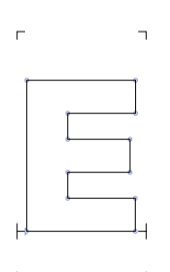

E 0045



Egrave 00C8

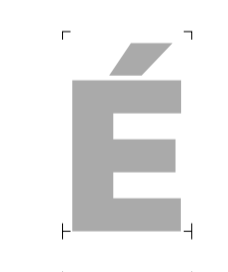

Eacute 00C9



Ecircumflex 00CA

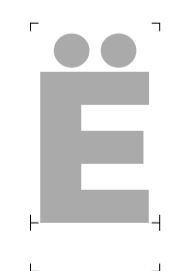

Edieresis 00CB

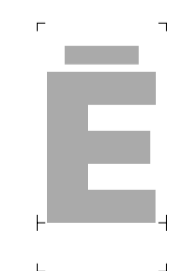

Emacron 0112



Ebreve 0114

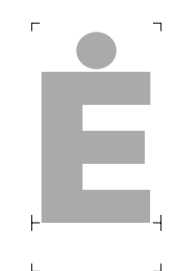

Edotaccent 0116



Eogonek 0118

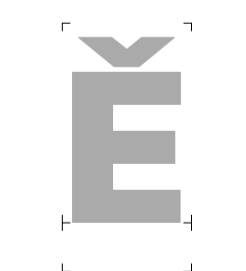

Ecaron 011A



Edblgrave 0204



Einvertedbreve 0206



uni0228 0228

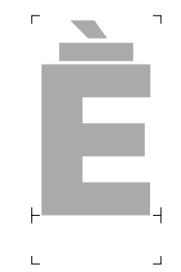

Emacrongrave 1E14



Emacronacute 1E16

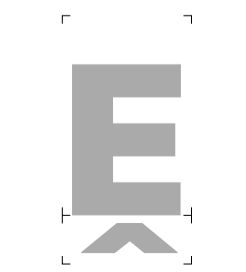

Ecircumflexbelow 1E18

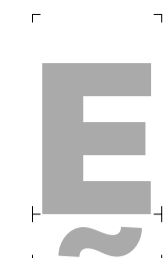

Etildebelow 1E1A



Ecedillabreve 1E1C

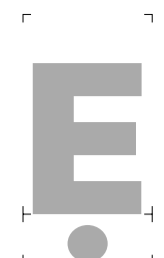

Edotbelow 1E88



Ehookabove 1E8A



Etilde 1EBC



Ecircumflexacute 1E8E



Ecircumflexgrave 1E00



Ecircumflexhookabove 1E02



Ecircumflextilde 1E04



Ecircumflexdotbelow 1E06

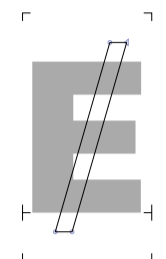

uni0246 0246



Eturn 018E



Epsilon 0395



Epsilontonos 0388



uni1F18 1F18



uni1F19 1F19



uni1F1A 1F1A



uni1F1B 1F1B



uni1F1C 1F1C



uni1F1D 1F1D



uni1FC8 1FC8



uni1FC9 1FC9



afii10022 0415



uni0400 0400



afii10023 0401



lebrevecyrillic 04D6

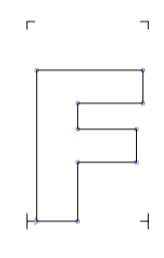

F 0046



Fhook 0191



Fdotaccent 1E1E



Fturn 2132

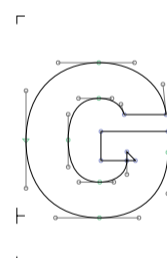

G 0047

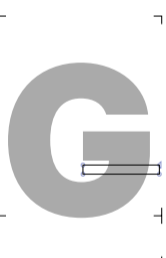

Gbar 01E4

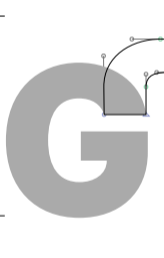

Ghook 0193



Gcircumflex 011C



Gbreve 011E



Gdotaccent 0120



Gcommaaccent 0122



Gcaron 01E6



Gacute 01F4



Gmacron 1E20

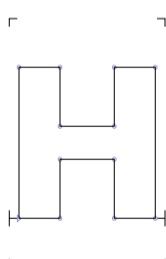

H 0048



Hcedilla 1E28



Hcircumflex 0124



uni021E 021E



Hdotaccent 1E22



Hdotbelow 1E24



Hdieresis 1E26



Hbrevebelow 1E2A

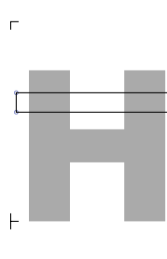

Hbar 0126



Ehookcyrillic 04C7



Endescendercyrillic 04A2



uni04C9 04C9

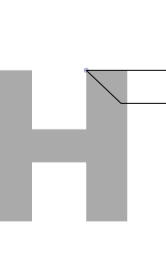

Enghecyrillic 04A4

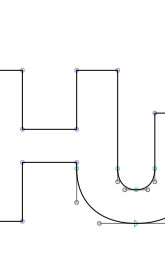

uni01F6 01F6

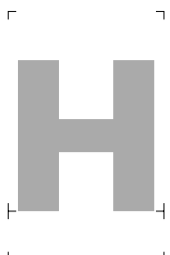

Eta 0397



Etatonos 0389



uni1F28 1F28

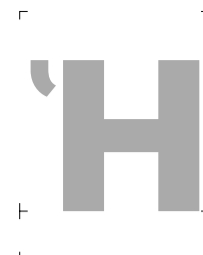

uni1F29 1F29



uni1F2A 1F2A



uni1F2B 1F2B



uni1F2C 1F2C



uni1F2D 1F2D



uni1F2E 1F2E



uni1F2F 1F2F

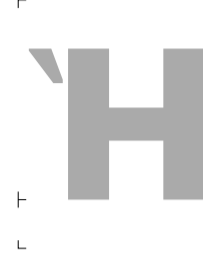

uni1FCA 1FCA



uni1FCB 1FCB

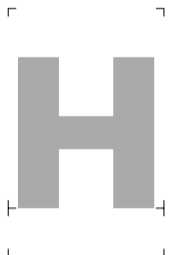

afi10031 041D



uni1F98 1F98



uni1F99 1F99



uni1F9A 1F9A



uni1F9B 1F9B



uni1F9C 1F9C



uni1F9D 1F9D



uni1F9E 1F9E



uni1F9F 1F9F

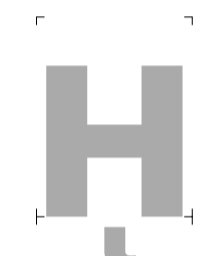

uni1FCC 1FCC

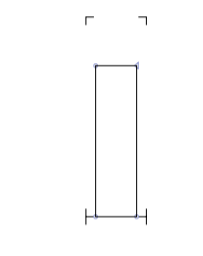

I 0049

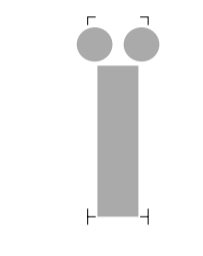

Idieresis 00CF



Idieresisacute 1E2E



Istroke 0197



Itildebelow 1E2C



Igrave 00CC



Iacute 00CD



Icircumflex 00CE



Itilde 0128



Imacron 012A



Ibreve 012C



Iogonek 012E



Idotaccent 0130



Icaron 01CF



Idblgrave 0208



Iinvertedbreve 020A



Ihookabove 1EC8



Idotbelow 1ECA



Iota 0399



Iotatonos 038A



Iotadieresis 03AA



uni1F38 1F38



uni1F39 1F39



uni1F3A 1F3A



uni1F3B 1F3B



uni1F3C 1F3C



uni1F3D 1F3D



uni1F3E 1F3E



uni1F3F 1F3F



uni1FD8 1FD8



uni1FD9 1FD9



uni1FDA 1FDA

--	--	--	--	--	--	--	--	--

--	--	--	--	--	--

--	--	--	--	--	--

--	--	--	--	--	--

--	--	--	--	--	--

						004A
--	--	--	--	--	--	------

--	--	--	--	--	--	--	--	--	--	--	--

--	--	--	--	--	--	--	--	--	--	--	--

--	--	--	--	--	--	--	--	--	--	--	--

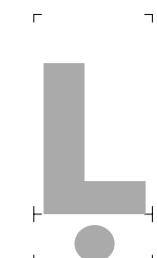

Ldotbelow 1E36



Ldotbelowmacron 1E38

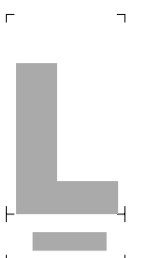

Llinebelow 1E3A



Lcircumflexbelow 1E3C

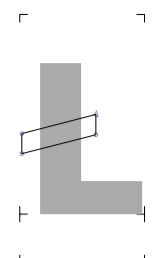

Lslash 0141

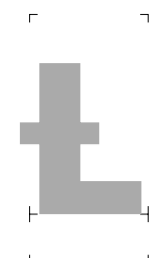

Lbar 023D



Lj 01C8

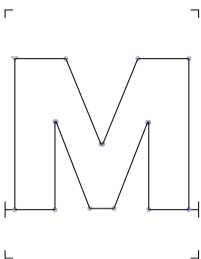

M 004D



Macute 1E3E



Mdotaccent 1E40



Mdotbelow 1E42



uni04CD 04CD



Mu 039C



uni03FA 03FA



afii10030 041C

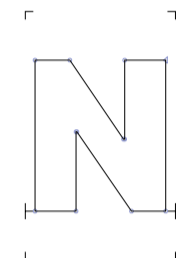

N 004E



Ntilde 00D1



Nacute 0143



Ncommaaccent 0145



Ncaron 0147



uni01F8 01F8



Ndotaccent 1E44



Ndotbelow 1E46



Nlinebelow 1E48



Ncircumflexbelow 1E4A

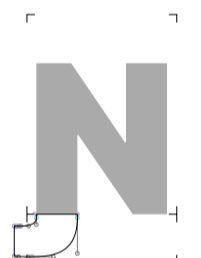

Nhook 019D

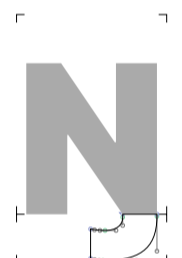

Eng 014A



afii10026 0418



uni040D 040D



afii10027 0419



Imacroncyrillic 04E2



Idieresiscyrillic 04E4



uni048A 048A



uni0376 0376



Nu 039D



Nj 01CB

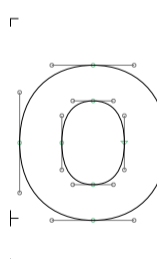

O 004F

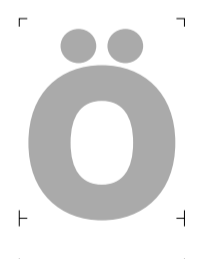

Odieresis 00D6



Otilde 00D5

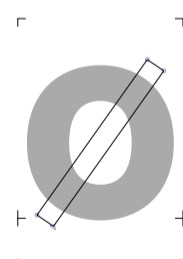

Oslash 00D8

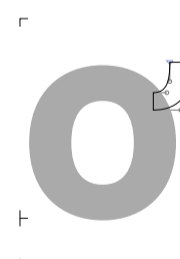

Ohorn 01A0

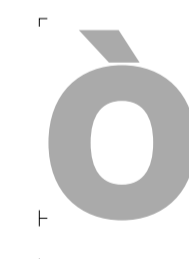

Ograve 00D2



Oacute 00D3

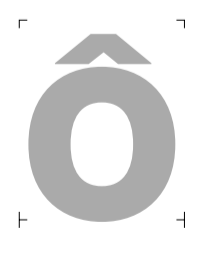

Ocircumflex 00D4

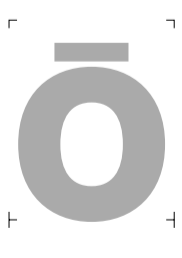

Omacron 014C

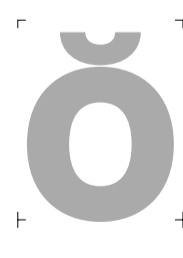

Obreve 014E



Ohungarumlaut 0150

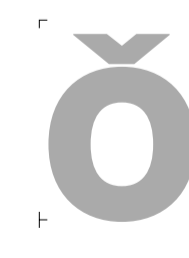

Ocaron 01D1



Oogonek 01EA

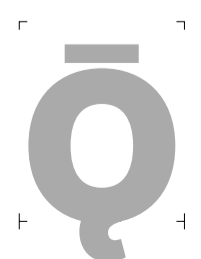

Oogonekmacron 01EC



Odblgrave 020C



Oinvertedbreve 020E



uni022A 022A



uni022C 022C

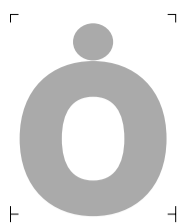

uni022E 022E

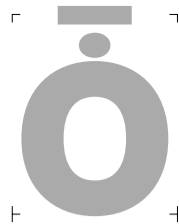

uni0230 0230



Otildeacute 1E4C



Otildedieresis 1E4E

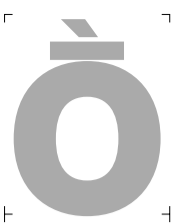

Omacrongrave 1E50



Omacronacute 1E52



Odotbelow 1ECC

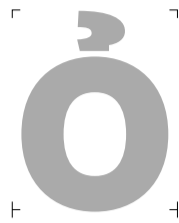

Ohookabove 1ECE

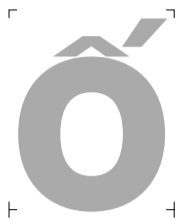

Ocircumflexacute 1ED0



Ocircumflexgrave 1ED2



Ocircumflexhookabove 1ED4



Ocircumflextilde 1ED6

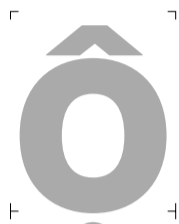

Ocircumflexdotbelow 1ED8



Ohornacute 1EDA



Ohorngrave 1EDC



Ohornhookabove 1EDE



Ohorntilde 1EE0



Ohorndotbelow 1EE2



Oslashacute 01FE



Omicron 039F



Omicrontonos 038C



uni1F48 1F48



uni1F49 1F49



uni1F4A 1F4A



uni1F4B 1F4B



uni1F4C 1F4C



uni1F4D 1F4D



uni1FF8 1FF8



uni03F4 03F4



uni1FF9 1FF9

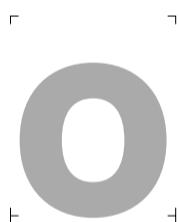

afi10032 041E



Odieresis Cyrillic 04E6



Obar 019F



Obarred Cyrillic 04E8



Obarreddieresis Cyrillic 04EA

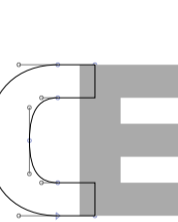

OE 0152

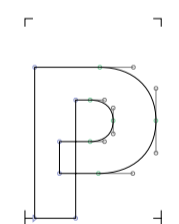

P 0050



Pacute 1E54



Pdotaccent 1E56

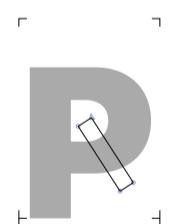

uni048E 048E

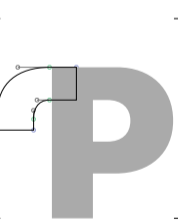

Phook 01A4



Rho 03A1



uni1FEC 1FEC

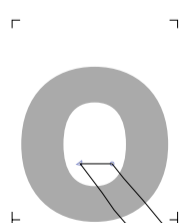

Q 0051

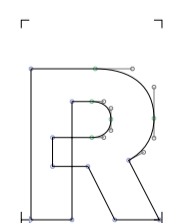

R 0052



Racute 0154



Rcommaaccent 0156



Rcaron 0158



Rdblgrave 0210



Rinvertedbreve 0212



Rdotaccent 1E58



Rdotbelow 1E5A



Rdotbelowmacron 1E5C



Rlinebelow 1E5E

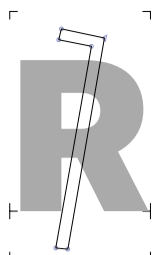

response 211F

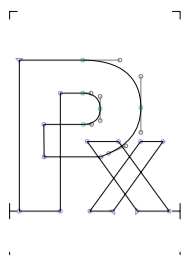

Rx 211E

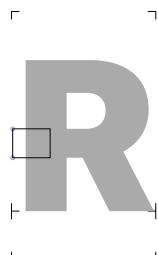

uni024C 024C

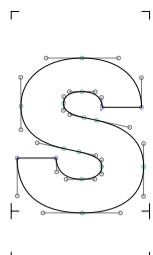

S 0053



Sacute 015A



Scircumflex 015C



Scedilla 015E

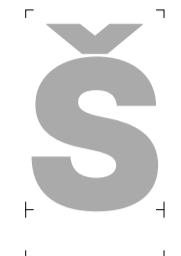

Scaron 0160



Scommaaccent 0218



Sdotaccent 1E60



Sdotbelow 1E62



Sacutedotaccent 1E64



Scarondotaccent 1E66



Sdotbelowdotaccent 1E68



afii10054 0405



Tonetwo 01A7

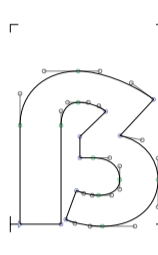

Germandbls 1E9E

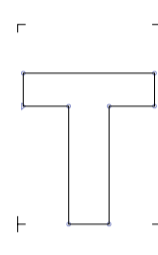

T 0054



Tcommaaccent 0162

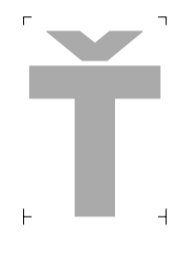

Tcaron 0164



uni021A 021A



Tdotaccent 1E6A



Tdotbelow 1E6C



Tlinebelow 1E6E



Tcircumflexbelow 1E70

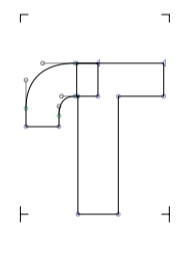

Thook 01AC



Trthook 01AE

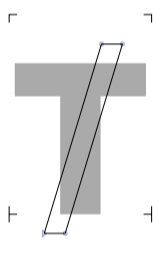

uni023E 023E



Tau 03A4

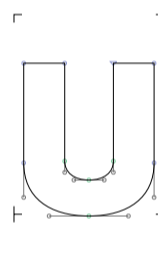

U 0055

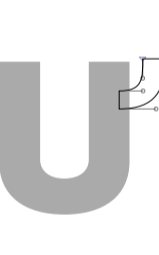

Uhorn 01AF



Ugrave 00D9



Uacute 00DA



Ucircumflex 00DB



Udieresis 00DC



Utilde 0168



Umacron 016A

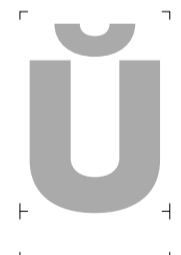

Ubreve 016C



Uring 016E



Uhungarumlaut 0170



Uogonek 0172



Ucaron 01D3



Udieresismacron 01D5



Udieresisacute 01D7



Udieresiscaron 01D9



Udieresisgrave 01DB



Udblgrave 0214



Uinvertedbreve 0216



Udieresisbelow 1E72



Utildebelow 1E74



Ucircumflexbelow 1E76



Utildeacute 1E78



Umacrodieresis 1E7A



Udotbelow 1EE4



Uhookabove 1EE6



Uhornacute 1EE8



Uhorngrave 1EEA



Uhornhookabove 1EEC



Uhorntilde 1EEE



Uhorndotbelow 1EF0

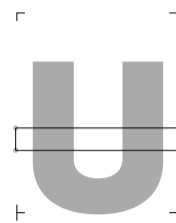

uni0244 0244

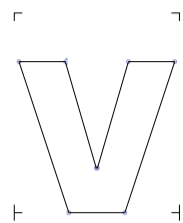

V 0056



Vtilde 1E7C



Vdotbelow 1E7E



W 0057



Wcircumflex 0174



Wgrave 1E80

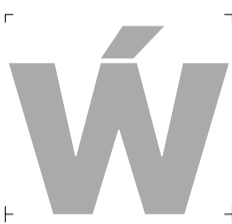

Wacute 1E82

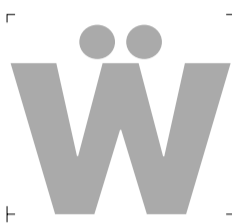

Wdieresis 1E84



Wdotaccent 1E86

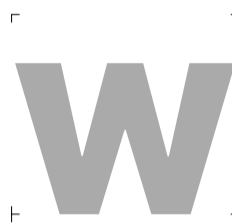

Wdotbelow 1E88

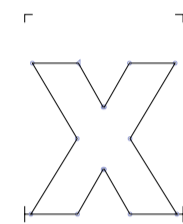

X 0058



Xdotaccent 1E8A



Xdieresis 1E8C



Hadescendercyrillic 04B2



uni04FC 04FC



Chi 03A7

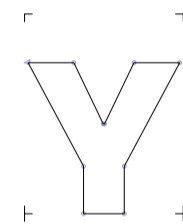

Y 0059

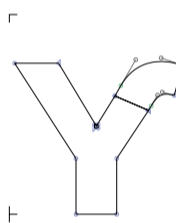

Yhook 01B3



Yacute 00DD



Ycircumflex 0176



Ydieresis 0178



uni0232 0232



Ydotaccent 1E8E



Ygrave 1EF2



Ydotbelow 1EF4



Yhookabove 1EF6



Ytilde 1EF8

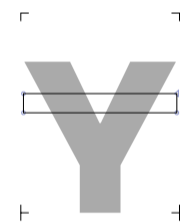

uni024E 024E



Upsilon 03A5

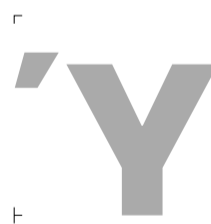

Upsilontonos 038E



Upsilondieresis 03AB



uni1F59 1F59



uni1F5B 1F5B



uni1F5D 1F5D



uni1F5F 1F5F



uni1FE8 1FE8



uni1FE9 1FE9



uni1FEA 1FEA



uni1FEB 1FEB

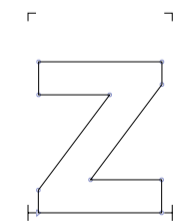

Z 005A



Zacute 0179



Zdotaccent 017B



Zcaron 017D



Zcircumflex 1E90



Zdotbelow 1E92



Zlinebelow 1E94

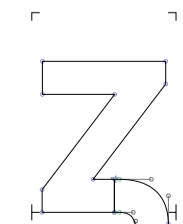

uni0224 0224



Zbar 01B5



Zeta 0396

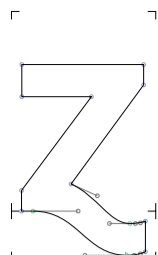

uni2C7F 2C7F

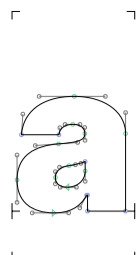

a 0061



adieresis 00E4



atilde 00E3



arighthalfring 1E9A



agrave 00E0



aacute 00E1



acircumflex 00E2



aring 00E5



amacron 0101



abreve 0103



aogonek 0105



acaron 01CE



adieresismacron 01DF



adotmacron 01E1



aringacute 01FB



adblgrave 0201



ainvertedbreve 0203



uni0227 0227



aringbelow 1E01



adotbelow 1EA1



ahookabove 1EA3



acircumflexacute 1EA5



acircumflexgrave 1EA7



acircumflexhookabove 1EA9



acircumflextilde 1EAB



acircumflexdotbelow 1EAD



abreveacute 1EAF



abrevegrave 1EB1



abrevehookabove 1EB3



abrevetilde 1EB5



abrevedotbelow 1EB7



aturn 0250



afii10065 0430



abrevocyrlilic 04D1



adieresiscyrlilic 04D3

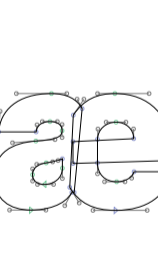

ae 00E6



aemacron 01E3



aeacute 01FD



aicyrlilic 04D5

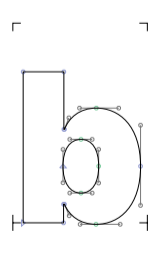

b 0062



bbar 0180

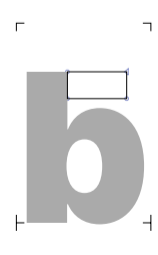

btopbar 0183

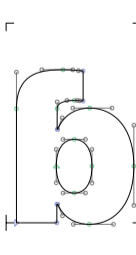

bhook 0253



bdotaccent 1E03



bdotbelow 1E05



blinebelow 1E07

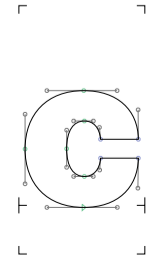

c 0063

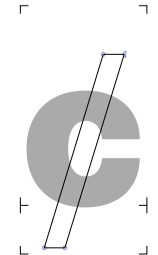

uni023C 023C

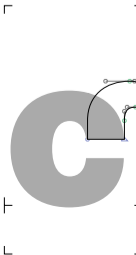

chook 0188

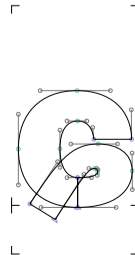

ccurl 0255



ccedilla 00E7



cacute 0107



ccircumflex 0109



cdotaccent 010B



ccaron 010D



ccedillaacute 1E09



sigmalunatesymbolgreek 03F2



escyrillic 0441



d 0064



dcroat 0111



drthook 0256

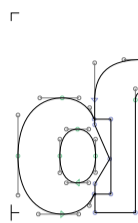

dhook 0257



dtopbar 018C



uni0221 0221



dcaron 010F



ddotaccent 1E0B



ddotbelow 1E0D



dlinebelow 1E0F



dcedilla 1E11



dcircumflexbelow 1E13



dz 02A3



dzcaron 01C6



dzcurl 02A5

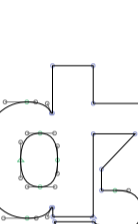

dyogh 02A4



dong 20AB

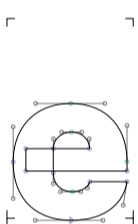

e 0065



edieresis 00EB

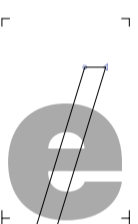

uni0247 0247



egrave 00E8



eacute 00E9



ecircumflex 00EA



emacron 0113



ebreve 0115



edotaccent 0117



eogonek 0119



ecaron 011B



edblgrave 0205



einvertedbreve 0207



uni0229 0229



emacrongrave 1E15



emacronacute 1E17



ecircumflexbelow 1E19



etildebelow 1E1B



ecedillabreve 1E1D



edotbelow 1EB9



ehookabove 1EBB



etilde 1EBD



ecircumflexacute 1EBF



ecircumflexgrave 1EC1



ecircumflexhookabove 1EC3



ecircumflextilde 1EC5



ecircumflexdotbelow 1EC7



icyrillic 0435



uni0450 0450



icyrillic 0451

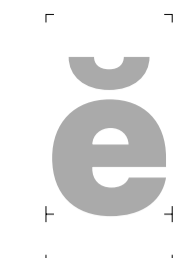

iebrevecyrllic 04D7



eturn 01DD

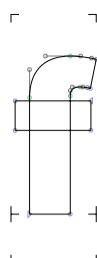

f 0066

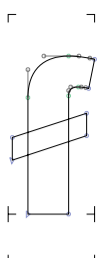

slongstroke 1E9C



slongdotaccent 1E9B



fdotaccent 1E1F



fmg 02A9

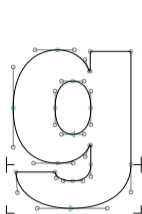

g 0067

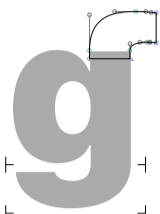

ghook 0260



gbar 01E5



gcircumflex 011D



gbreve 011F



gdotaccent 0121



gcommaaccent 0123



gcaron 01E7



gacute 01F5



gmacron 1E21

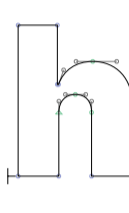

h 0068



hcedilla 1E29



tshecyrillic 045B



djecyrlilic 0452

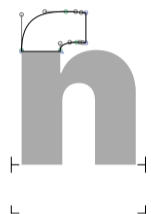

hhook 0266



henghook 0267

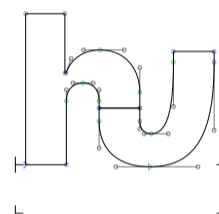

hv 0195

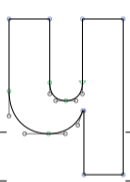

hturn 0265

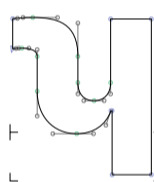

hturnlhook 02AE

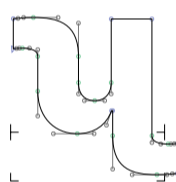

hturnhook2 02AF



hbar 0127



hcircumflex 0125



uni021F 021F



hdotaccent 1E23



hdotbelow 1E25



hdieresis 1E27



hbrevebelow 1E2B



hlinebelow 1E96



shhacyrillic 04BB



i 0069



idotless 0131



idieresis 00EF



idieresisacute 1E2F



itilde 0129



itildebelow 1E2D



uni1E2D.ccmp



ibar 0268



igrave 00EC



iacute 00ED



icircumflex 00EE



imacron 012B



ibreve 012D



uni012F.ccmp



iogonek 012F



icaron 01D0

























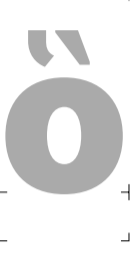

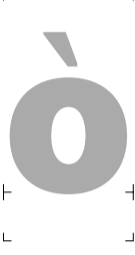
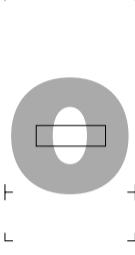
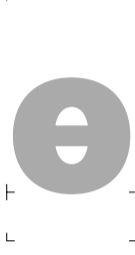
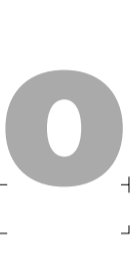
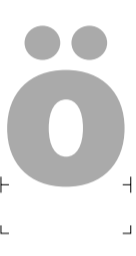
idblgrave 0209

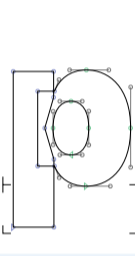
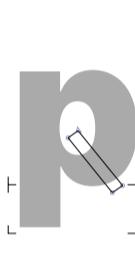

iinvertedbreve 020B

ihookabove 1EC9	idotbelow 1ECB	uni1ECB.ccmp	jdotless 0237	jdotlessbar 025F	uni0249 0249
uni0249.ccmp	icyrillic 0456	yicyrillic 0457	ij 0133	j 006A	jcrosstail.ccmp
jcrosstail 029D	jcircumflex 0135	jcaron 01F0	yotgreek 03F3	jecyrillic 0458	lj 01C9
k 006B	khook 0199	kcommaaccent 0137	kcaron 01E9	kacute 1E31	kdotbelow 1E33
klinebelow 1E35	kturn 029E	l 006C	lslash 0142	lbar 019A	lmidtilde 026B
lrrhook 026D	lbelt 026C	lcurl 0234	ldot 0140	lacute 013A	lcommaaccent 013C
lcaron 013E	ldotbelow 1E37	ldotbelowmacron 1E39	llinebelow 1E3B	lcircumflexbelow 1E3D	l.ss02
lslash.ss02	lbar.ss02	lmidtilde.ss02	lbelt.ss02	ldot.ss02	lacute.ss02
lcommaaccent.ss02	lcaron.ss02	ldotbelow.ss02	ldotbelowmacron.ss02	llinebelow.ss02	lcircumflexbelow.ss02

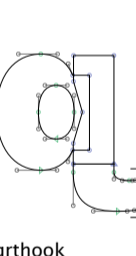
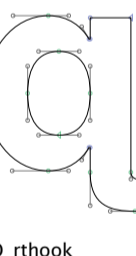
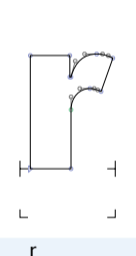
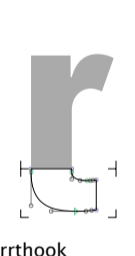
uni04CF 04CF	m 006D	mhook 0271	mturn 026F	mturndescend 0270	macute 1E3F
mdotaccent 1E41	mdotbelow 1E43	n 006E	ntilde 00F1	nrthook 0273	eng 014B
ncurl 0235	nlfthook 0272	nlegrightlong 019E	nacute 0144	ncommaaccent 0146	ncaron 0148
uni01F9 01F9	ndotaccent 1E45	ndotbelow 1E47	nlinebelow 1E49	ncircumflexbelow 1E4B	nj 01CC
o 006F	odieresis 00F6	otilde 00F5	oslash 00F8	ohorn 01A1	ograve 00F2
oacute 00F3	ocircumflex 00F4	omacron 014D	obreve 014F	ohungarumlaut 0151	ocaron 01D2
oogonek 01EB	oogonekmacron 01ED	odblgrave 020D	oinvertedbreve 020F	uni022B 022B	uni022D 022D
uni022F 022F	uni0231 0231	otildeacute 1E4D	otildedieresis 1E4F	omacrongrave 1E51	omacronacute 1E53
odotbelow 1ECD	ohookabove 1ECF	ocircumflexacute 1ED1	ocircumflexgrave 1ED3	ocircumflexhookabove 1ED5	ocircumflextilde 1ED7

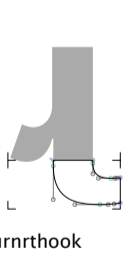
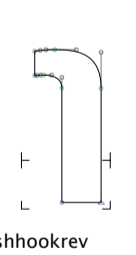
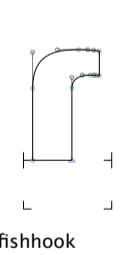
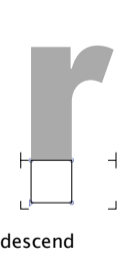
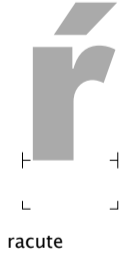
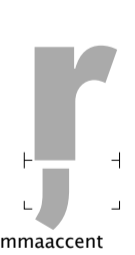
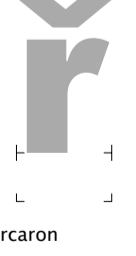
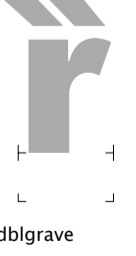
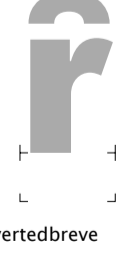
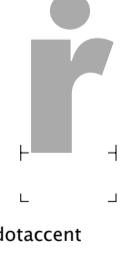
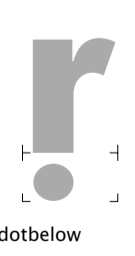
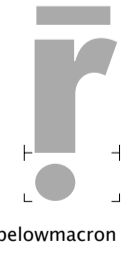
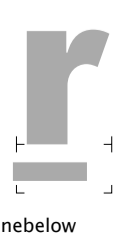
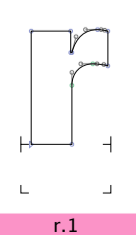
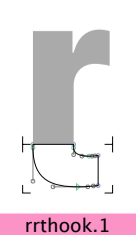
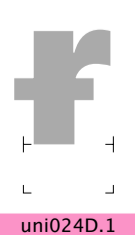
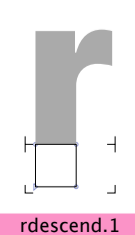
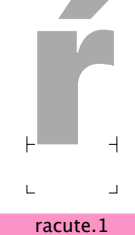
					
ocircumflexdotbelow 1ED9	ohornacute 1EDB	ohorngrave 1EDD	ohornhookabove 1EDF	ohorntilde 1EE1	ohorndotbelow 1EE3
					
oslashacute 01FF	omicron 03BF	omicrontonos 03CC	uni1F40 1F40	uni1F41 1F41	uni1F42 1F42
					
uni1F43 1F43	uni1F44 1F44	uni1F45 1F45	uni1F78 1F78	fitacyrillic 0473	obar 0275
					
ocyrillic 043E	odieresiscyrillic 04E7	oe 0153	ukcyrillic 0479	p 0070	uni048F 048F
					
phook 01A5	pacute 1E55	pdotaccent 1E57	ercyrillic 0440	q 0071	qhook 02A0
					
qrhook 024B	Q_rhook 024A	r 0072	rrhook 027D	uni024D 024D	rturn 0279
					
rturnrhook 027B	rfishhookrev 027F	rfishhook 027E	rdescend 027C	racute 0155	rcommaaccent 0157
					
rcaron 0159	rdblgrave 0211	rinvetdbreve 0213	rdotaccent 1E59	rdotbelow 1E5B	rdotbelowmacron 1E5D
					
rlinebelow 1E5F	r.1	rrhook.1	uni024D.1	rdescend.1	racute.1

rcommaaccent.1	rcaron.1	rdblgrave.1	rinvertedbreve.1	rdotaccent.1	rdotbelow.1
rdotbelowmacron.1	rlinebelow.1	s 0073	srhook 0282	uni023F 023F	sacute 015B
scircumflex 015D	scedilla 015F	scaron 0161	scommaaccent 0219	sdotaccent 1E61	sdotbelow 1E63
sacutedotaccent 1E65	scarondotaccent 1E67	sdotbelowdotaccent 1E69	dzecyrillic 0455	tonetwo 01A8	germandbls 00DF
germandbls.1	t 0074	tpalatalhook 01AB	trhook 0288	tcurl 0236	tcurl 02A8
tturn 0287	tbar 0167	tcommaaccent 0163	tcaron 0165	uni021B 021B	tdotaccent 1E6B
tdotbelow 1E6D	tlinebelow 1E6F	tcircumflexbelow 1E71	tdieresis 1E97	u 0075	udieresis 00FC
utilde 0169	uhorn 01B0	micro 00B5	ubar 0289	ugrave 00F9	uacute 00FA
ucircumflex 00FB	umacron 0168	ubreve 016D	uring 016F	uhungarumlaut 0171	uogonek 0173



ucaron 01D4



udieresismacron 01D6



udieresisacute 01D8



udieresiscaron 01DA



udieresisgrave 01DC



udblgrave 0215



uinvertedbreve 0217



udieresisbelow 1E73



utildebelow 1E75



ucircumflexbelow 1E77



utildeacute 1E79



umacrondieresis 1E7B



udotbelow 1EE5



uhookabove 1EE7



uhornacute 1EE9



uhorngrave 1EEB



uhornhookabove 1EED



uhorntilde 1EEF



uhorndotbelow 1EF1

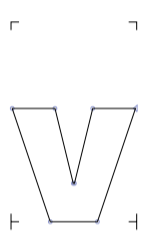

v 0076



vturn 028C



vtilde 1E7D



vdotbelow 1E7F



w 0077



wdieresis 1E85



wturn 028D



wcircumflex 0175



wgrave 1E81



wacute 1E83



wdotaccent 1E87



wdotbelow 1E89



wring 1E98

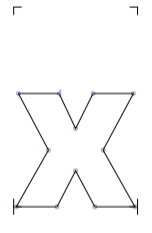

x 0078



xdotaccent 1E8B



xdieresis 1E8D



khacyrillic 0445

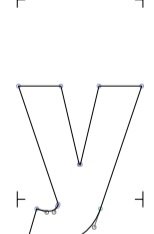

y 0079



ydieresis 00FF

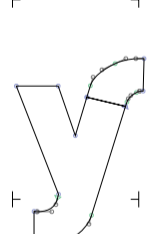

yhook 01B4

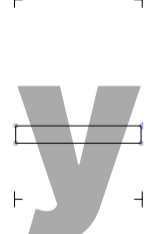

uni024F 024F



yacute 00FD



ycircumflex 0177



uni0233 0233



ydotaccent 1E8F



yring 1E99



ygrave 1EF3



ydotbelow 1EF5



yhookabove 1EF7



ytilde 1EF9



ucyrillic 0443



ushortcyrillic 045E



umacroncyrillic 04EF



udieresiscyrillic 04F1



uhungarumlautcyrillic 04F3

yturn 028E	z 007A	zbar 01B6	zhook 0225	uni0240 0240	zrthook 0290
zacute 017A	zdotaccent 017C	zcaron 017E	zcircumflex 1E91	zdotbelow 1E93	zlinebelow 1E95
zcurl 0291	Thorn 00DE	Gamma 0393	Delta 0394	Theta 0398	Xi 039E
Pi 03A0	Sigma 03A3	Phi 03A6	Psi 03A8	Omega 03A9	uni1FFB 1FFB
Omegatonos 038F	uni1F68 1F68	uni1F69 1F69	uni1F6A 1F6A	uni1F6B 1F6B	uni1F6C 1F6C
uni1F6D 1F6D	uni1F6E 1F6E	uni1F6F 1F6F	uni1FFA 1FFA	uni1FA8 1FA8	uni1FA9 1FA9
uni1FAA 1FAA	uni1FAB 1FAB	uni1FAC 1FAC	uni1FAD 1FAD	uni1FAE 1FAE	uni1FAF 1FAF
uni1FFC 1FFC	Upsilon2 01B1	Upsilonhooksymbol 03D2	Upsilonacutehooksgre 03D3	Upsilondieresishooksgre 03D4	Gamma1 0194
afii10018 0411	afii10050 0490	uni04FA 04FA	afii10021 0414	afii10024 0416	Zhedescendercyrillic 0496



afii10025 0417

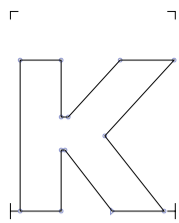

Kacyr 041A

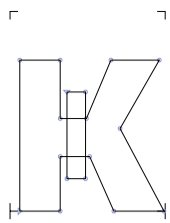

Kavertikalstrokeycyrillic 049C

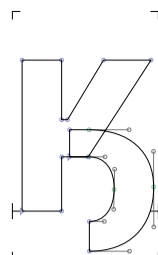

Kahookcyrillic 04C3

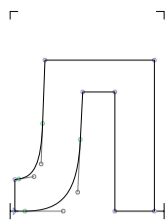

afii10029 041B

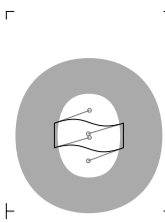

afii10147 0472

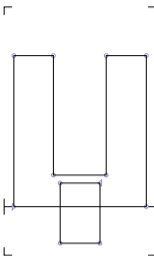

afii10145 040F

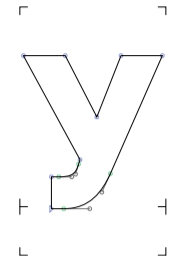

afii10037 0423

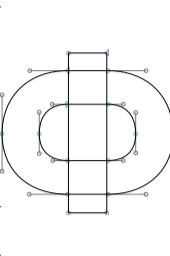

afii10038 0424

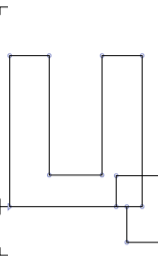

afii10040 0426

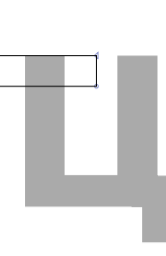

Tetsecyrillic 0484

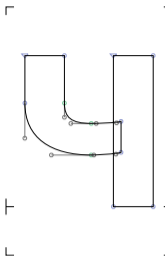

afii10041 0427



Chedescendercyrillic 04B6

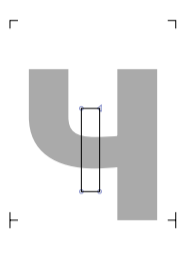

Cheverticalstrokeycyrillic 04B8



Shhacyrillic 04BA



afii10060 040B

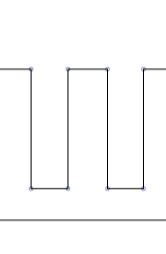

afii10042 0428



afii10043 0429

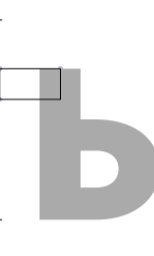

afii10044 042A



afii10045 042B

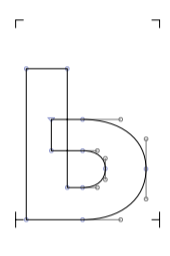

afii10046 042C

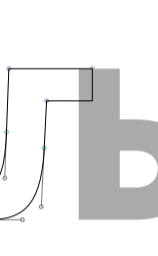

afii10058 0409

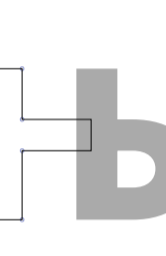

afii10059 040A

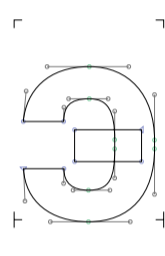

afii10047 042D



afii10048 042E



afii10049 042F



Ghemiddlehookcyrillic 0494



Pemiddlehookcyrillic 04A6

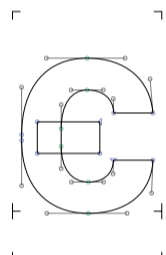

afii10053 0404

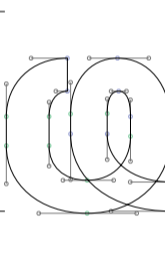

Haabkhasiancyrillic 04A8

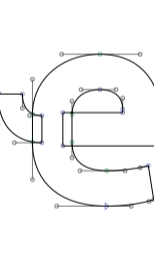

Cheabkhasiancyrillic 04BC

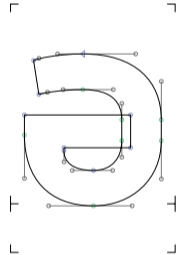

Schwacyrillic 04D8



Dzeabkhasiancyrillic 04E0

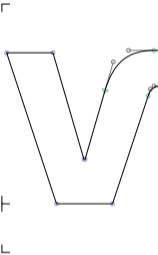

afii10148 0474

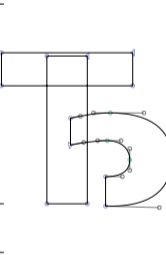

afii10051 0402

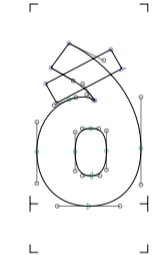

eth 00F0

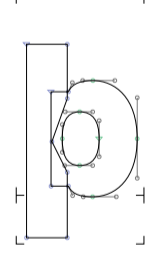

thorn 00FE

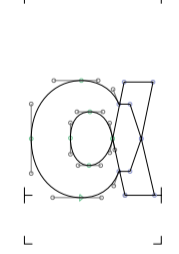

alpha 03B1



alphatonos 03AC

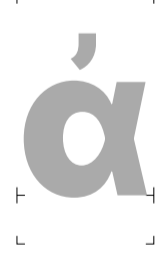

uni1F00 1F00



uni1F01 1F01

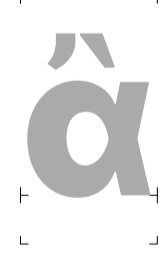

uni1F02 1F02



uni1F03 1F03



uni1F04 1F04



uni1F05 1F05



uni1F06 1F06



uni1F07 1F07



uni1F70 1F70



uni1F80 1F80

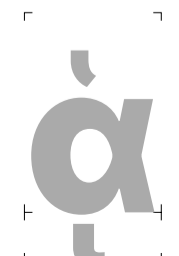

uni1F81 1F81



uni1F82 1F82



uni1F83 1F83



uni1F84 1F84



uni1F85 1F85

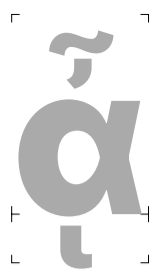

uni1F86 1F86



uni1F87 1F87



uni1F80 1F80



uni1F81 1F81



uni1F82 1F82



uni1F83 1F83

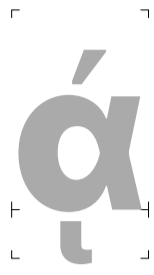

uni1F84 1F84

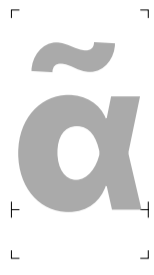

uni1F86 1F86



uni1F87 1F87

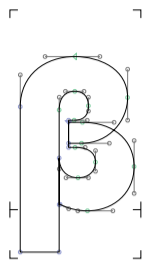

beta 03B2

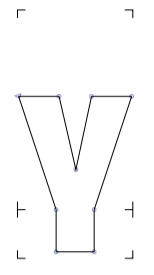

gamma 03B3

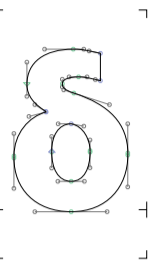

delta 03B4

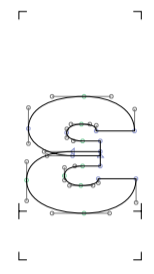

epsilon 03B5



epsilonontonos 03AD

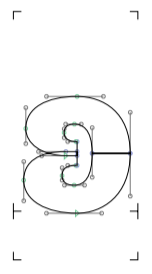

epsilonclosed 029A



epsilon1 025B



epsilon1rev 025C

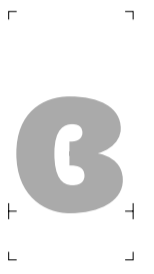

epsilon1revclosed 025E

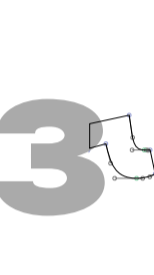

epsilon1revhook 025D



uni1F10 1F10



uni1F11 1F11



uni1F12 1F12



uni1F13 1F13



uni1F14 1F14



uni1F15 1F15



uni1F72 1F72

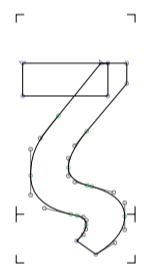

zeta 03B6

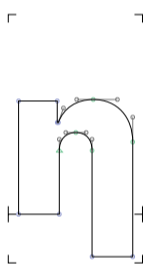

eta 03B7



etatonos 03AE



uni1F20 1F20



uni1F21 1F21



uni1F22 1F22



uni1F23 1F23



uni1F24 1F24



uni1F25 1F25



uni1F26 1F26



uni1F27 1F27



uni1F74 1F74



uni1F90 1F90



uni1F91 1F91



uni1F92 1F92



uni1F93 1F93



uni1F94 1F94



uni1F95 1F95



uni1F96 1F96

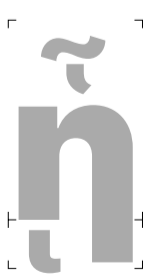

uni1F97 1F97



uni1FC2 1FC2



uni1FC3 1FC3



uni1FC4 1FC4



uni1FC6 1FC6



uni1FC7 1FC7

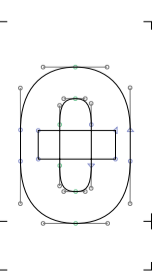

theta 03B8

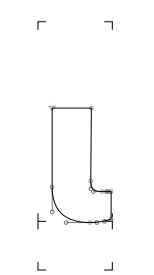

iota 03B9



iotadierestonos 0390



iotatonos 03AF



iotadieresis 03CA



uni1F30 1F30



uni1F31 1F31



uni1F32 1F32



uni1F33 1F33



uni1F34 1F34



uni1F35 1F35



uni1F36 1F36



uni1F37 1F37



uni1F76 1F76



uni1FD0 1FD0



uni1FD1 1FD1



uni1FD2 1FD2



uni1FD6 1FD6



uni1FD7 1FD7

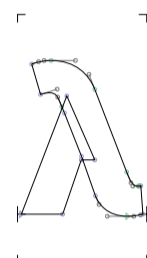

lambda 03BB

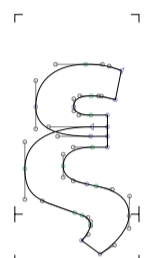

xi 03BE

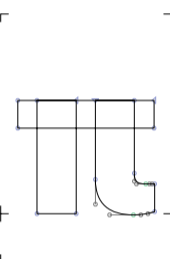

pi 03C0

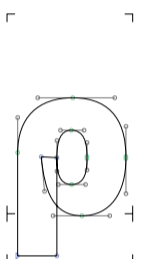

rho 03C1



uni1FE4 1FE4



uni1FE5 1FE5



uni03FC 03FC

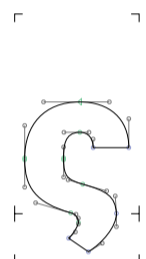

sigma1 03C2

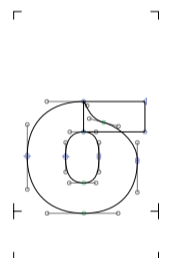

sigma 03C3

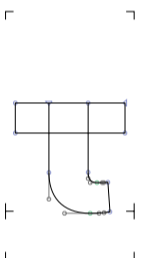

tau 03C4

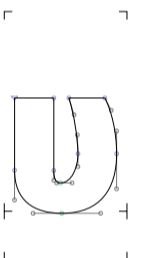

upsilon 03C5



upsilondieresis 03B0



upsilondieresis 03CB



upsilontonos 03CD



uni1F50 1F50



uni1F51 1F51



uni1F52 1F52



uni1F53 1F53



uni1F54 1F54



uni1F55 1F55



uni1F56 1F56



uni1F57 1F57



uni1F7A 1F7A



uni1FE0 1FE0



uni1FE1 1FE1



uni1FE2 1FE2



uni1FE6 1FE6



uni1FE7 1FE7

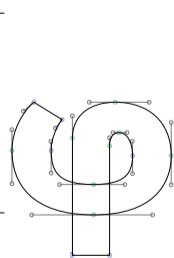

phi 03C6

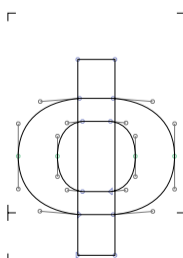

phigreek 03D5

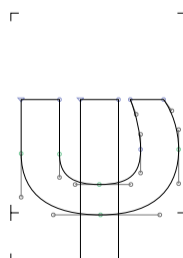

psi 03C8

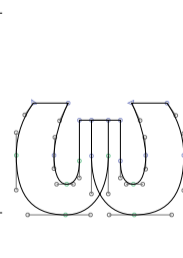

omega 03C9



omegatonos 03CE



uni1F60 1F60



uni1F61 1F61



uni1F62 1F62











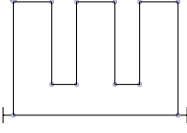
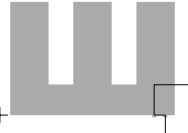
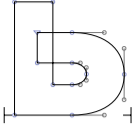
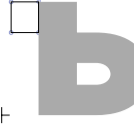

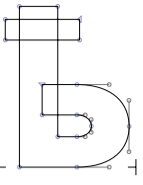
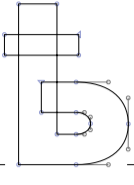
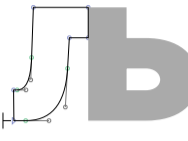
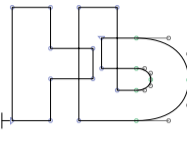
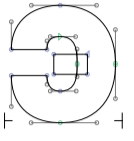
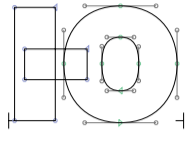
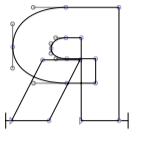
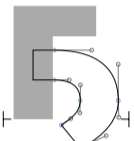
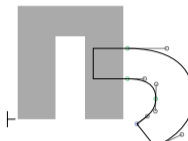
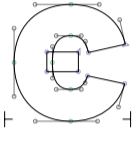
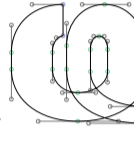
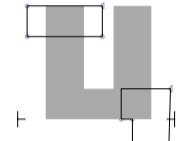
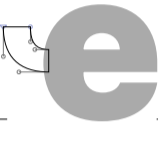

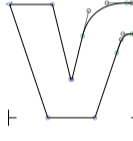

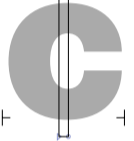
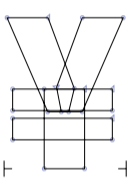
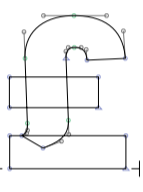
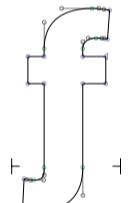
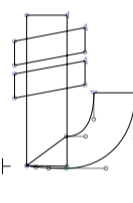
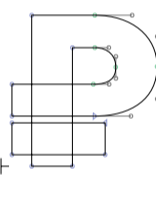
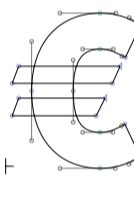
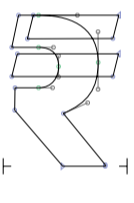
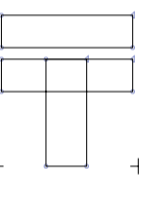
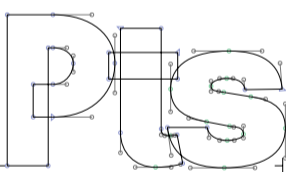
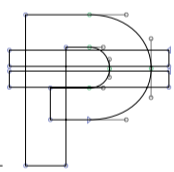
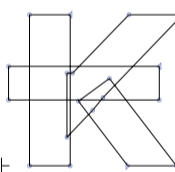
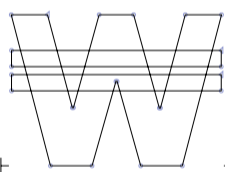
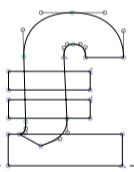
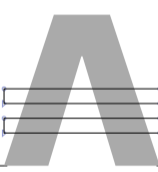
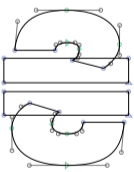
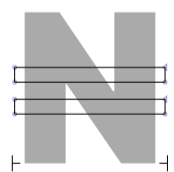
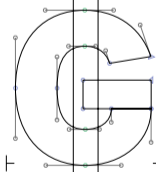
uni1F63 1F63

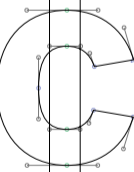
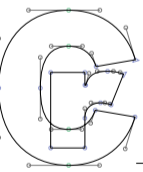
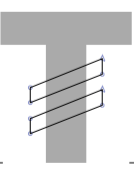
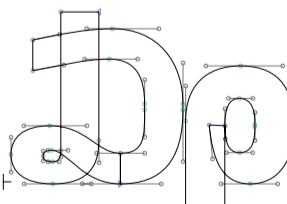
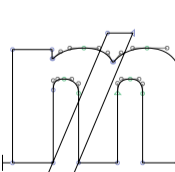
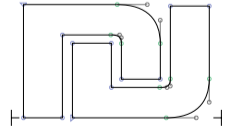
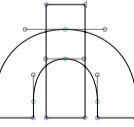

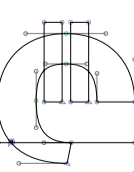
uni1F64 1F64

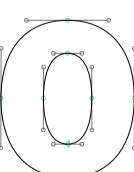
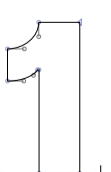

					
shacyrillic 0448	shchacyrillic 0449	softsigncyrillic 044C	hardsigncyrillic 044A	yericrillic 044B	uni048D 048D
					
yatcyrillic 0463	ljecyrillic 0459	njecyrillic 045A	ereversedcyrillic 044D	iucyrillic 044E	iacyrillic 044F
					
ghemiddlehookcyrillic 0495	pemiddlehookcyrillic 04A7	ecyrillic 0454	haabkhasiancyrillic 04A9	tetsecyrillic 04B5	cheabkhasiancyrillic 04BD
					
dzeabkhasiancyrillic 04E1	izhitsacyrillic 0475	dollar 0024	cent 00A2	yen 00A5	sterling 00A3
					
florin 0192	uni20BA 20BA	uni20BD 20BD	euro 20AC	uni20B9 20B9	tenge 20B8
					
peseta 20A7	peso 20B1	kip 20AD	won 20A9	lira 20A4	austral 20B3
					
hryvnia 20B4	naira 20A6	guarani 20B2	coloncurrenncy 20A1	cedi 20B5	cruzeiro 20A2
					
tugrik 20AE	uni20AF 20AF	mill 20A5	afi57636 20AA	manat 20BC	rupee 20A8
					
lari 20BE	franc 20A3	zero 0030	one 0031	two 0032	twostroke 01BB

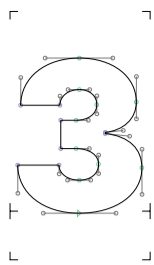

three 0033

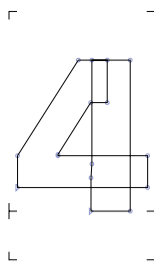

four 0034

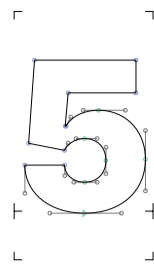

five 0035

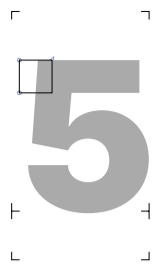

Tonefive 01BC

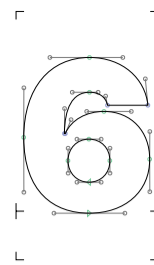

six 0036

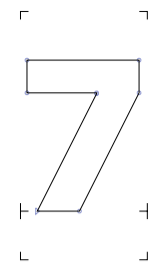

seven 0037

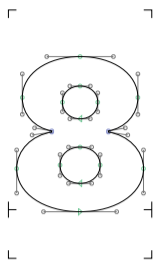

eight 0038

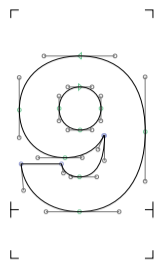

nine 0039

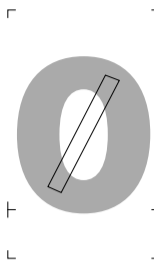

zero.slash

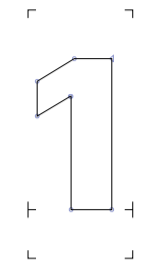

one.ss01

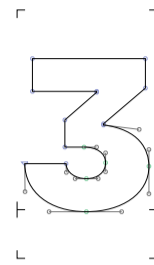

three.1

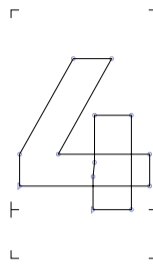

four.ss01

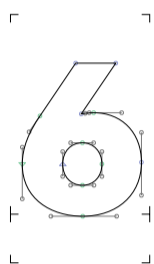

six.ss01

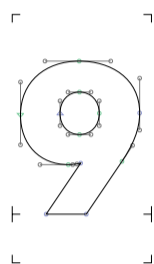

nine.ss01

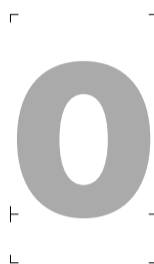

zero.tf



one.tf



two.tf



three.tf



four.tf



five.tf



six.tf



seven.tf



eight.tf



nine.tf



zero.tf.slash



one.tf.ss01



three.1.tf



four.tf.ss01



six.tf.ss01



nine.tf.ss01

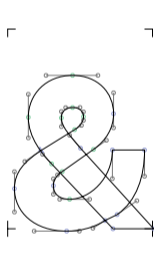

ampersand 0026



exclam 0021



exclamdbl 203C



exclamdown 00A1



uni2049 2049

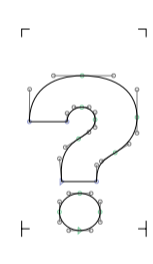

question 003F

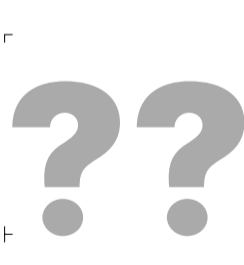

uni2047 2047



uni2048 2048



questiondown 00BF

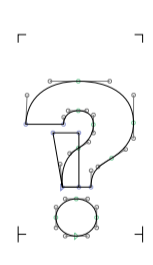

interrobang 203D



invertedinterrobang 2E18

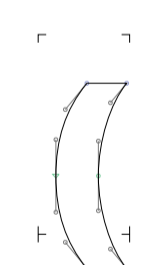

parenleft 0028



parenright 0029

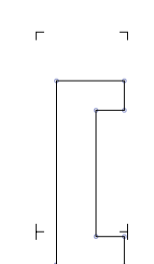

bracketleft 005B

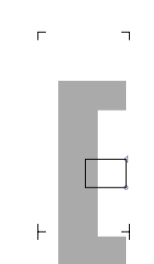

bracketleft_quill 2045



bracketright 005D



bracketright_quill 2046

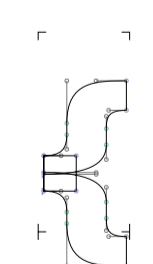

braceleft 007B



bracerright 007D

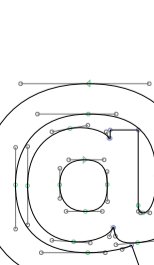

at 0040



parenleft.case















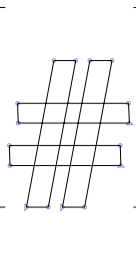
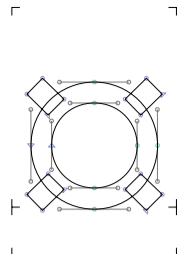
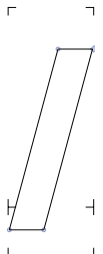
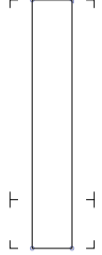
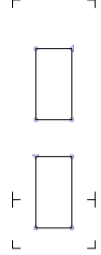
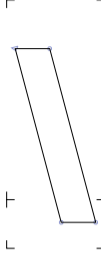
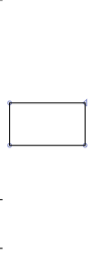
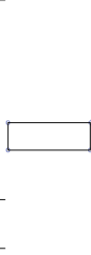

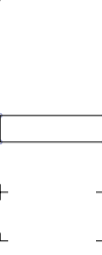
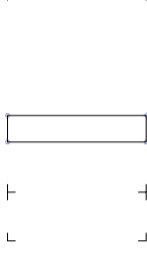
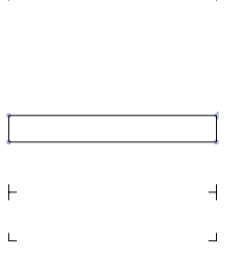
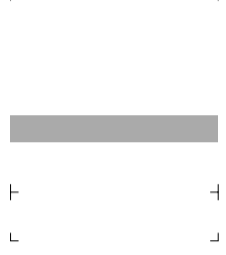
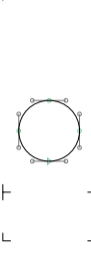
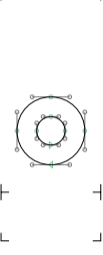

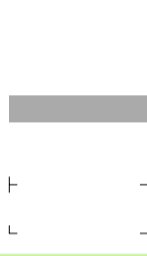
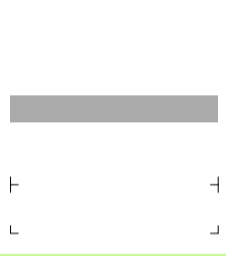

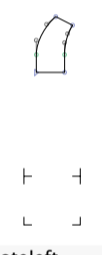
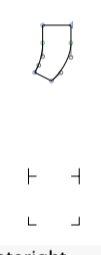











parenright.case

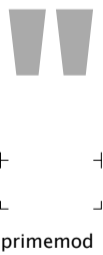
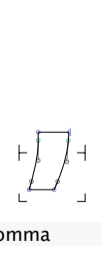

bracketleft.case

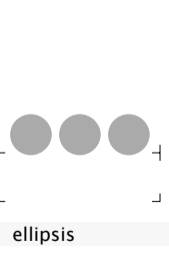
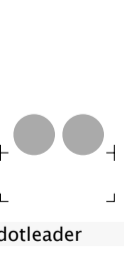

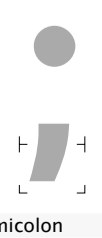
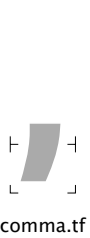
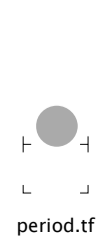
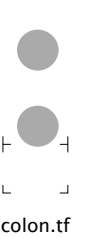
bracketright.case

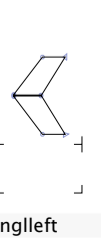
					
braceleft.case 007C	braceright.case 00A6	at.case 005C	numbersign 0023	currency 00A4	slash 002F
					
bar 007C	brokenbar 00A6	backslash 005C	hyphenbullet 2043	hyphen 002D	softhyphen 00AD
					
endash 2013	figuredash 2012	emdash 2014	horizontalbar 2015	bullet 2022	openbullet 25E6
					
hyphen.case 007C	endash.case 007C	figuredash.case 007C	emdash.case 007C	bullet.case 007C	openbullet.case 007C
					
quoteleft 2018	quoteright 2019	apostrophemod 02BC	quotesingle 0027	quotedbl 0022	quotedblleft 201C
					
quotedblright 201D	quotedblbase 201E	quotesinglbase 201A	prime 2032	doubleprime 2033	tripleprime 2034
					
quadrupleprime 2057	primerev 2035	doubleprimerev 2036	tripleprimerev 2037	primemod 02B9	doubleprimemod 02BA
					
comma 002C	period 002E	ellipsis 2026	twodotleader 2025	colon 003A	colon.case 003A
					
semicolon 003B	comma.tf 003B	period.tf 003B	colon.tf 003B	semicolon.tf 003B	guilsinglleft 2039



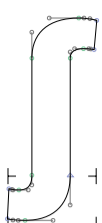
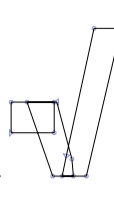
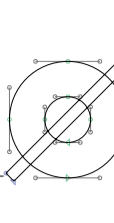
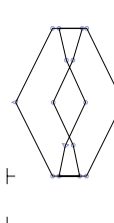
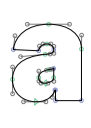
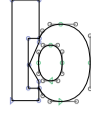

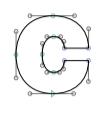
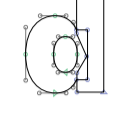
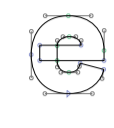
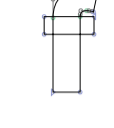
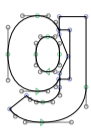
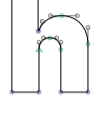
guilsingright 203A	guillemetleft 00AB	guillemetright 00BB	less 003C	greater 003E	lessequal 2264
greaterequal 2265	equal 003D	notequal 2260	plus 002B	minus 2212	multiply 00D7
divide 00F7	plusminus 00B1	approxequal 2248	asciitilde 007E	less.case	greater.case
lessequal.case	greaterequal.case	equal.case	notequal.case	plus.case	minus.case
multiply.case	divide.case	plusminus.case	approxequal.case	asciitilde.case	logicalnot 00AC
periodcentered 00B7	anoteleia 0387	questiongreek 037E	underscore 005F	dagger 2020	daggerdbl 2021
asciicircum 005E	asterisk 002A	asterisk.case	registered 00AE	trademark 2122	servicemark 2120
degree 00B0	ordfeminine 00AA	ordmasculine 00BA	i.numr	n.numr	paragraph 00B6
section 00A7	copyright 00A9	infinity 221E	partialdiff 2202	summation 2211	product 220F

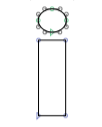
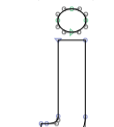
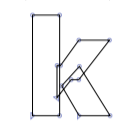
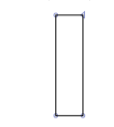
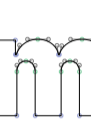
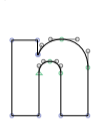
					
integral 222B	radical 221A	emptyset 2205	lozenge 25CA	a.sups 1D43	b.sups 1D47

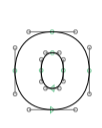
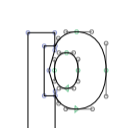
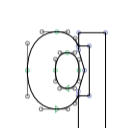
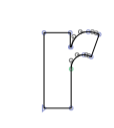
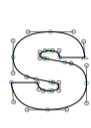
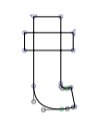

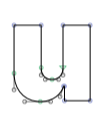

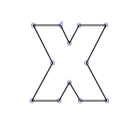
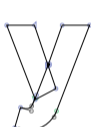
					
c.sups 1D9C	d.sups 1D48	e.sups 1D49	f.sups 1DA0	g.sups 1D4D	h.sups 02B0



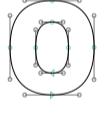
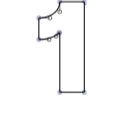
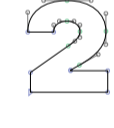
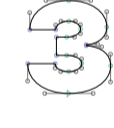
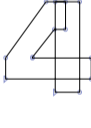
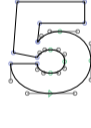

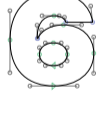
					
i.sups 2071	j.sups 02B2	k.sups 1D4F	l.sups 02E1	m.sups 1D50	n.sups 207F

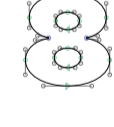
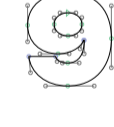

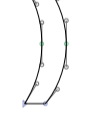

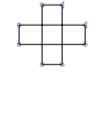
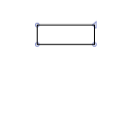
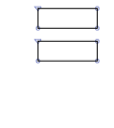
					
o.sups 1D52	p.sups 1D56	q.sups 146B	r.sups 02B3	s.sups 02E2	t.sups 1D57

					
u.sups 1D58	v.sups 1D5B	w.sups 02B7	x.sups 02E3	y.sups 02B8	z.sups 1D8B

					
zero.sups 2070	one.sups 00B9	two.sups 00B2	three.sups 00B3	four.sups 2074	five.sups 2075

					
six.sups 2076	seven.sups 2077	eight.sups 2078	nine.sups 2079	parenleft.sups 207D	parenright.sups 207E

					
plus.sups 207A	minus.sups 207B	equal.sups 207C	a.subs 2090	b.subs	c.subs

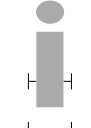
					
d.subs	e.subs 2091	f.subs	g.subs	h.subs 2095	i.subs 1D62

j.subs	2C7C	k.subs	2096	l.subs	2097	m.subs	2098	n.subs	2099	o.subs	2092
--------	------	--------	------	--------	------	--------	------	--------	------	--------	------

p.subs	209A	q.subs		r.subs	1D63	s.subs	209B	t.subs	209C	u.subs	1D64
--------	------	--------	--	--------	------	--------	------	--------	------	--------	------

v.subs	1D65	w.subs		x.subs	2093	y.subs		z.subs		zero.subs	2080
--------	------	--------	--	--------	------	--------	--	--------	--	-----------	------

one.subs	2081	two.subs	2082	three.subs	2083	four.subs	2084	five.subs	2085	six.subs	2086
----------	------	----------	------	------------	------	-----------	------	-----------	------	----------	------

seven.subs	2087	eight.subs	2088	nine.subs	2089	parenleft.subs	208D	parenright.subs	208E	plus.subs	208A
------------	------	------------	------	-----------	------	----------------	------	-----------------	------	-----------	------

minus.subs	208B	equal.subs	208C	zero.dnomf		one.dnomf		two.dnomf		three.dnomf	
------------	------	------------	------	------------	--	-----------	--	-----------	--	-------------	--

four.dnomf		five.dnomf		six.dnomf		seven.dnomf		eight.dnomf		nine.dnomf	
------------	--	------------	--	-----------	--	-------------	--	-------------	--	------------	--

fraction	2044	zero.dnom		one.dnom		two.dnom		three.dnom		four.dnom	
----------	------	-----------	--	----------	--	----------	--	------------	--	-----------	--

five.dnom		six.dnom		seven.dnom		eight.dnom		nine.dnom		plus.dnom	
-----------	--	----------	--	------------	--	------------	--	-----------	--	-----------	--

minus.dnom	equal.dnom	parenleft.dnom	parenright.dnom	zero.numr	one.numr

two.numr	three.numr	four.numr	five.numr	six.numr	seven.numr

eight.numr	nine.numr	plus.numr	minus.numr	equal.numr	parenleft.numr

parenright.numr	zero.frac	one.frac	two.frac	three.frac	four.frac











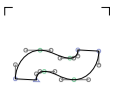

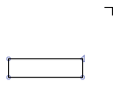
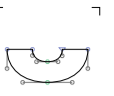

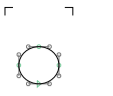

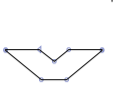
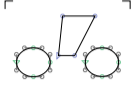





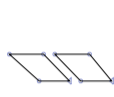





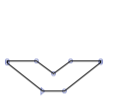











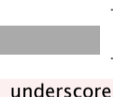

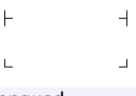
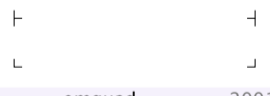
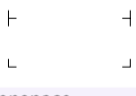
five.frac	six.frac	seven.frac	eight.frac	nine.frac	onehalf 00BD

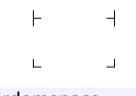
onequarter 00BC	threequarters 00BE	fivesixths 215A	onefraction 215F	seveneighths 215E	oneeighth 215B







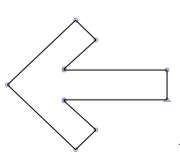
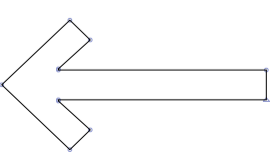
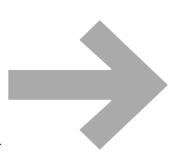
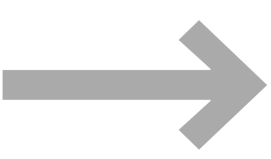
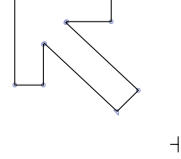

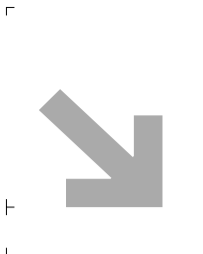
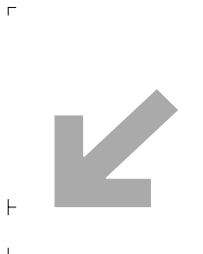
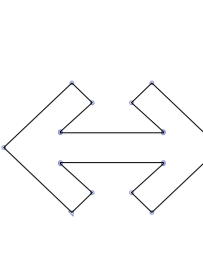
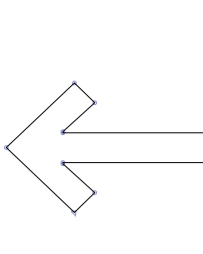
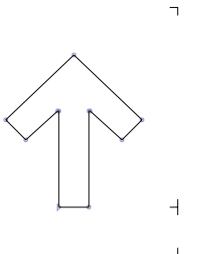
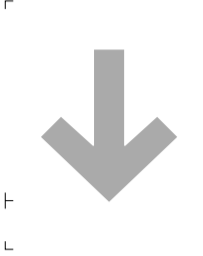
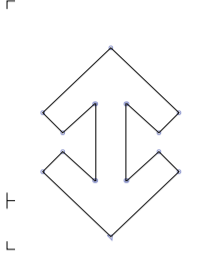
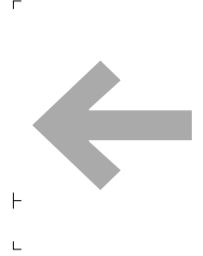
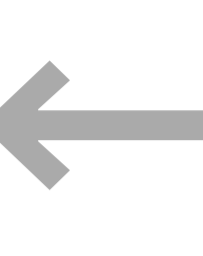
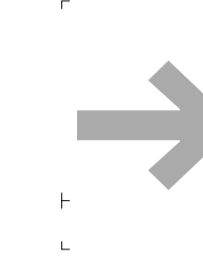
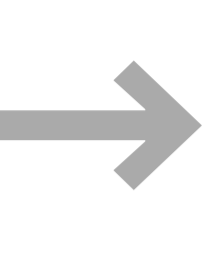
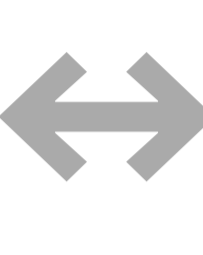
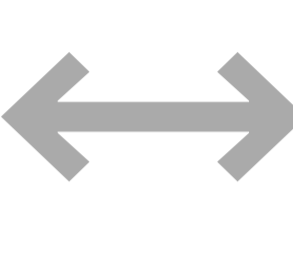
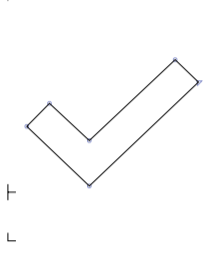
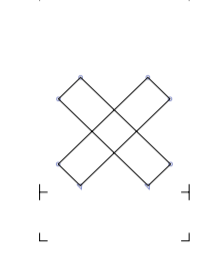
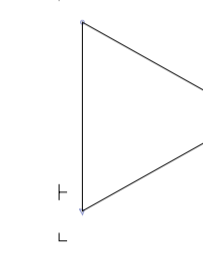
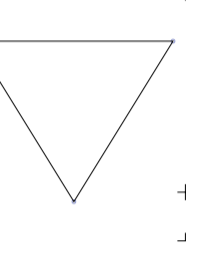
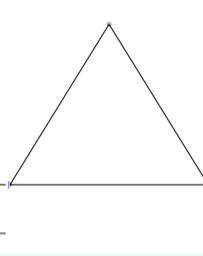
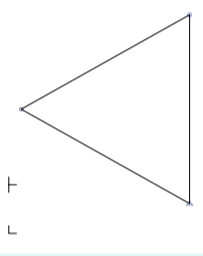
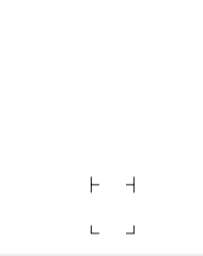
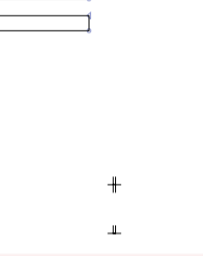
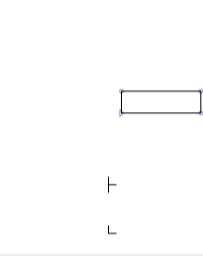
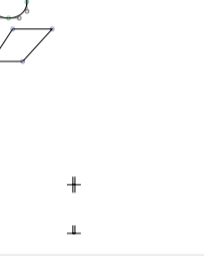
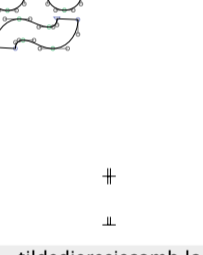
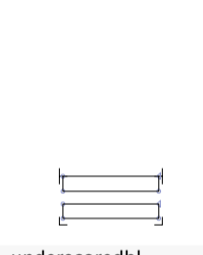
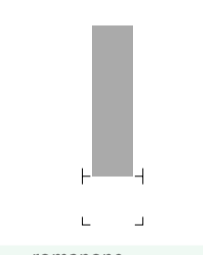
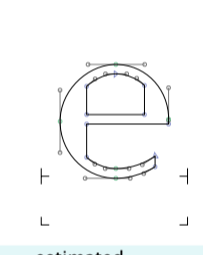
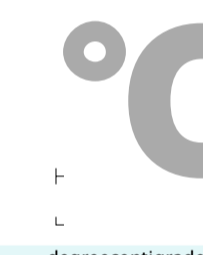
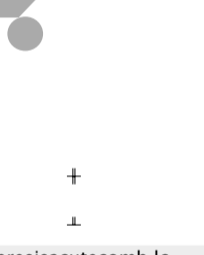
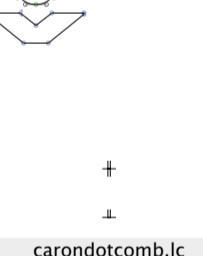
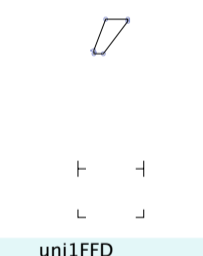
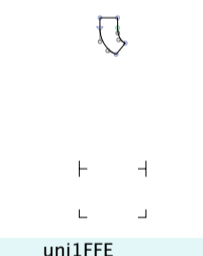
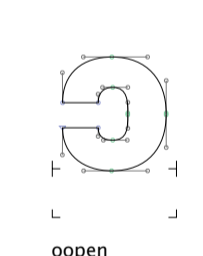
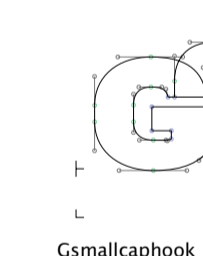
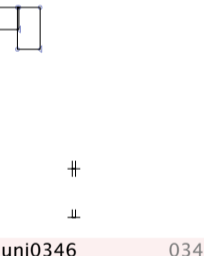
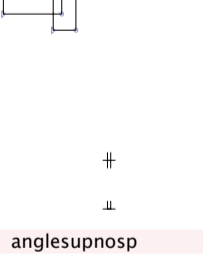
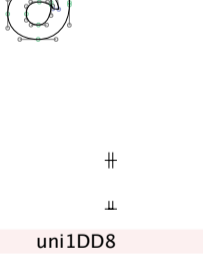
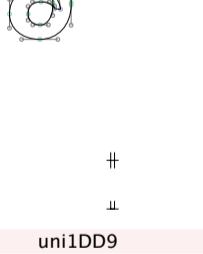
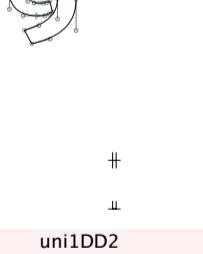
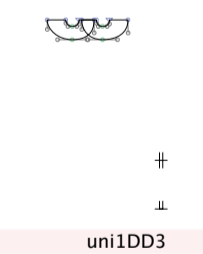
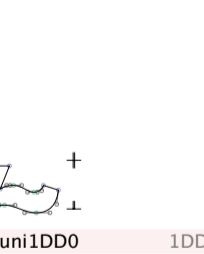
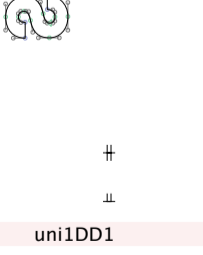
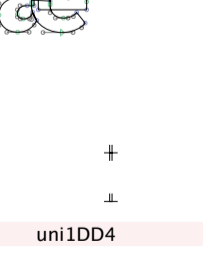
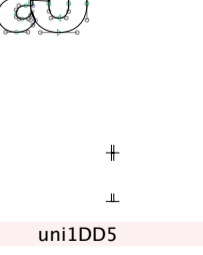
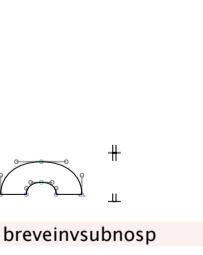
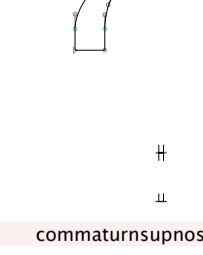
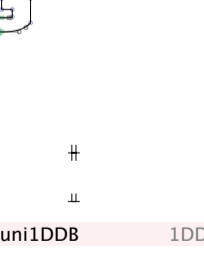
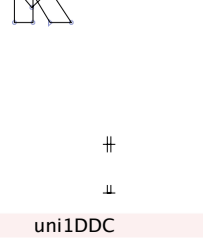
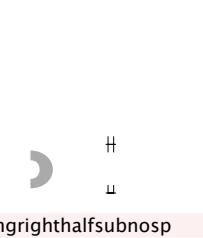
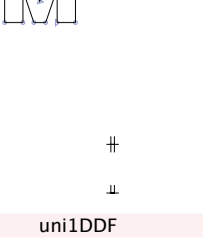
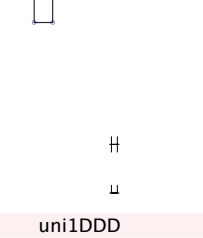
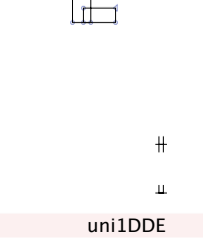
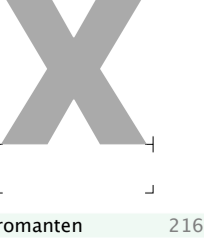

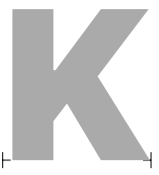
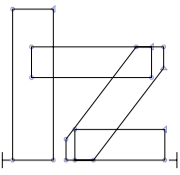
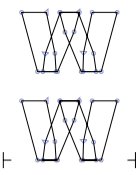

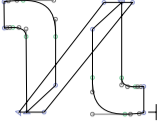
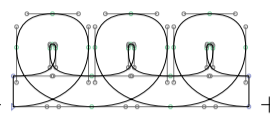
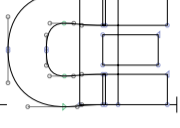

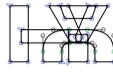
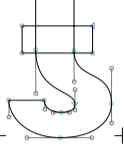
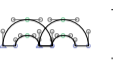
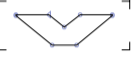
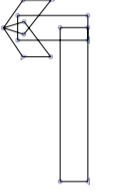
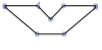

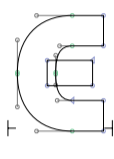
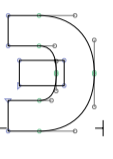

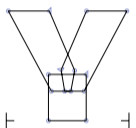
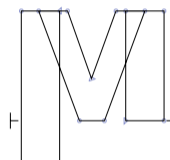
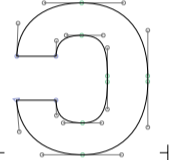

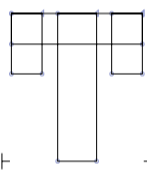
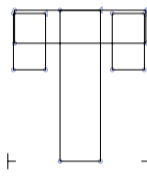
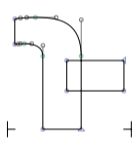
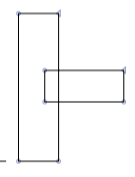
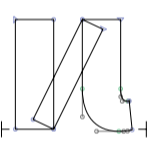

fiveeighths 215D	threeeighths 215C	percent 0025	perthousand 2030	pertenthousand 2031	uni214D 214D

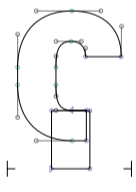
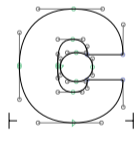
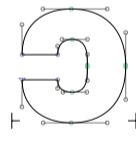
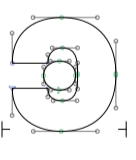
cadauna 2106	careof 2105	accountof 2100	addresssubject 2101	numero 2116	acute 00B4

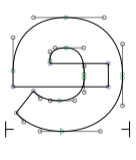
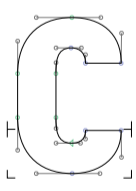
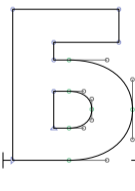
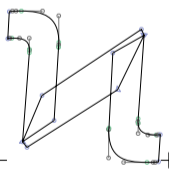
hungarumlaut 02DD	grave 0060	tonos 0384	dieresis 00A8	casedieresis.cn	circumflex 02C6

					
tilde 02DC	casetilde.cn	macron 00AF	breve 02D8	cyrillicbreve	dotaccent 02D9
					
ring 02DA	caron 02C7	dieresistonos 0385	cedilla 00B8	ogonek 02DB	commaaccent F6C3
					
acutecomb 0301	acutedblnosp 0308	gravecomb 0300	dblgravecmb 030F	macroncomb 0304	dieresisnosp 0308
					
brevenosp 0306	breveinvnosp 0311	hook 0309	circumflexnosp 0302	caroncmb 030C	tildecomb 0303
					
dotnosp 0307	ringnosp 030A	hornnosp 031B	ogoneknosp 0328	cedillanosp 0327	circumflexsubnosp 032D
					
brevesubnosp 032E	dotbelow 0323	commabelowcmb 0326	dotdblsubnosp 0324	ringsubnosp 0325	underscorenosp 0332
					
tildesubnosp 0330	enquad 2000	emquad 2001	enspace 2002	emspace 2003	thirdemspace 2004
					
quarteremspace 2005	sixthemspace 2006	figurespace 2007	punctuationspace 2008	thinspace 2009	hairspace 200A
					
zerowidthspace 200B	leftArrow 2190	leftLongArrow 27F5	rightArrow 2192	rightLongArrow 27F6	northWestArrow 2196

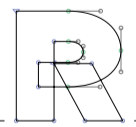
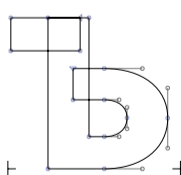
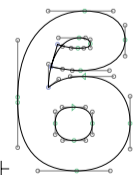
					
northEastArrow 2197	southEastArrow 2198	southWestArrow 2199	leftRightArrow 2194	leftRightLongArrow 27F7	upArrow 2191
					
downArrow 2193	upDownArrow 2195	leftArrow.case	leftLongArrow.case	rightArrow.case	rightLongArrow.case
					
leftRightArrow.case	leftRightLongArrow.case	dngb_check 2713	dngb_ballotx 2717	triagr 258A	triagdn 258C
					
triagup 2582	blackleftpointingtriangle 25C0	uni2009.fra	overscoredblno sp 033F	crossbar	acutedotcomb.lc
					
tildedieresiscomb.lc	underscoredbl 2017	romanone 2160	estimated 212E	degreecentigrade 2103	dieresisacutecomb.lc
					
carondotcomb.lc	uni1FFD 1FFD	uni1FFE 1FFE	oopen 0254	Gsmallcaphook 029B	uni0346 0346
					
anglesupno sp 031A	uni1DD8 1DD8	uni1DD9 1DD9	uni1DD2 1DD2	uni1DD3 1DD3	uni1DD0 1DD0
					
uni1DD1 1DD1	uni1DD4 1DD4	uni1DD5 1DD5	breveinvsubno sp 032F	commaturno supno sp 0312	uni1DDB 1DDB
					
uni1DDC 1DDC	ringright halfsubno sp 0339	uni1DDF 1DDF	uni1DDD 1DDD	uni1DDE 1DDE	romanten 2169

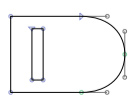
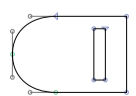
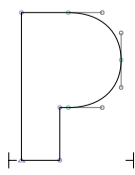
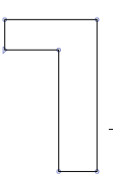
					
degrefahrenheit 2109	degreekelvin 212A	uni02AB 02AB	uni02AC 02AC	uni1FCD 1FCD	kappa1 03F0
					
uni214F 214F	OESmallcap 0276	tackupsubnosp 031D	uni2DFF 2DFF	glottalstopbarinv 018E	seagullsubnosp 033C
					
uni02EC 02EC	afi300 200F	caronnosp	romanfour 2163	uni03F5 03F5	uni03F6 03F6
					
longs 017F	trianglebullet 2023	Ysmallcap 028F	uni03FB 03FB	uni03FD 03FD	uni03FE 03FE
					
uni03FF 03FF	uni0373 0373	uni0372 0372	uni0371 0371	uni0370 0370	uni0377 0377
					
gravesubnosp 0316	undertie 203F	barmidshortnosp 0335	glottalstopprevinv 0295	uni037C 037C	uni037B 037B
					
uni037D 037D	uni213B 213B	erev 0258	cstretch 0297	Btopbar 0182	Koppa 03DE
					
commaturnedmod 02BB	commareversedmod 02BD	ringhalfleft 02BF	Rsmallcap 0280	Tonesix 0184	beta1 03D0
					
uni204F 204F	uni204E 204E	uni204D 204D	uni204C 204C	uni204B 204B	uni204A 204A

CR	slashlongnosp 0338	exclam1 01C3	Digamma 03DC	candrabinunossp 0310	qofdagesh 02DF
uni036A 036A	uni036B 036B	uni036C 036C	uni036D 036D	uni036E 036E	uni036F 036F
uni20B7 20B7	uni20B6 20B6	uni20B0 20B0	uni20BB 20BB	tildedoublecmb 0360	breveinverteddoublecmb 0361
uni0362 0362	uni0363 0363	uni0364 0364	uni0365 0365	uni0366 0366	uni0367 0367
uni0368 0368	uni0369 0369	tildemidnossp 0334	uni01F7 01F7	glottalstopinv 0296	acutelowmod 02CF
gravelowmod 02CE	fourthtonechinese 02CB	verticallinelowmod 02CC	secondtonechinese 02CA	romantwelve 216B	uni2183 2183
arrowheadupmod 02C4	arrowheaddownmod 02C5	arrowheadleftmod 02C2	arrowheadrightmod 02C3	glottalstopmod 02C0	firsttonechinese 02C9
uni021D 021D	uni0268.ccmp	uni021C 021C	numeralgreeksub 0375	caronsubnossp	uni205E 205E
uni205A 205A	uni205B 205B	uni205C 205C	schwahook 025A	uni1E9D 1E9D	uni1E9F 1E9F

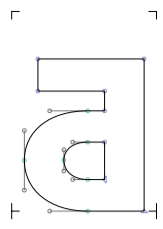

Dtopbar 018B

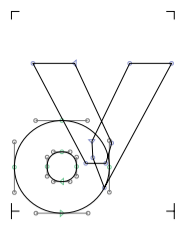

uni1EFE 1EFE

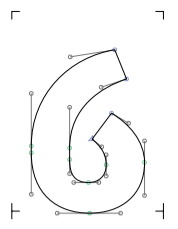

uni1EFD 1EFD

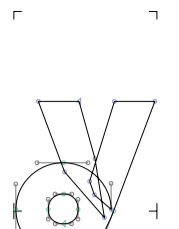

uni1EFF 1EFF



uni1EFA 1EFA

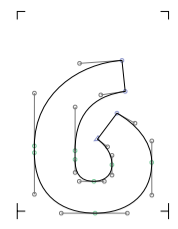

uni1EFC 1EFC

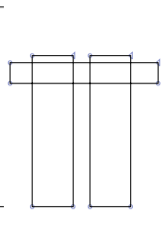

uni1EFB 1EFB

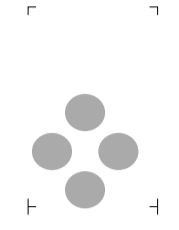

uni2058 2058

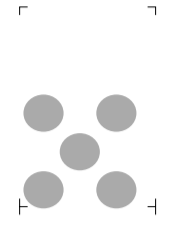

uni2059 2059



uni2054 2054

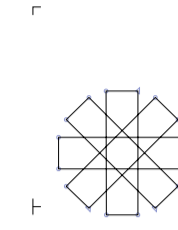

uni2055 2055

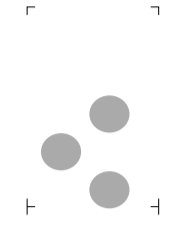

uni2056 2056



uni2050 2050

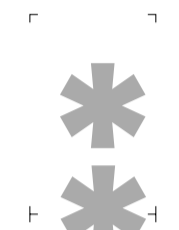

uni2051 2051

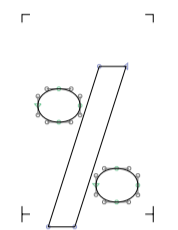

uni2052 2052

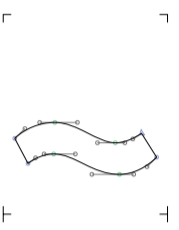

uni2053 2053



ascript_ uni02DE

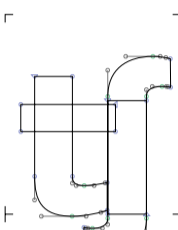

tesh 02A7

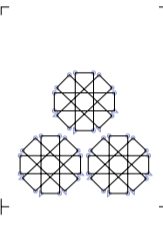

asterism 2042

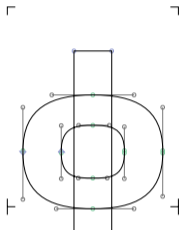

philatin 0278



sixroman 2175

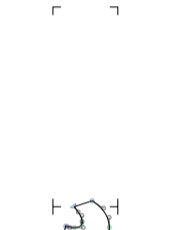

cyrillichookleft

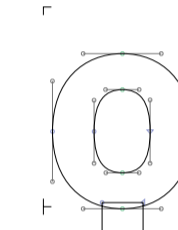

uni03D8 03D8

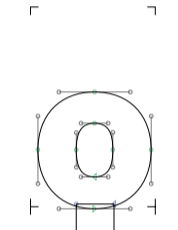

uni03D9 03D9

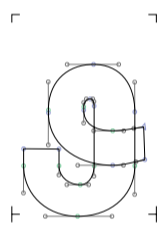

thetasymbolgreek 03D1

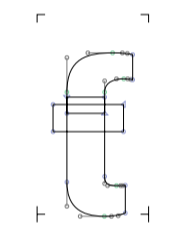

thook 01AD

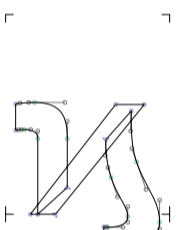

uni03D7 03D7

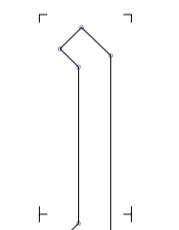

uni27EF 27EF

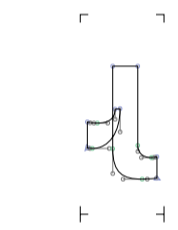

finaltsadi 02B5

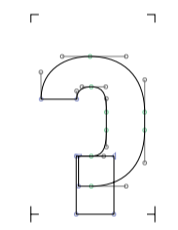

glottalstop 0294

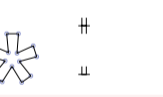

uni0359 0359

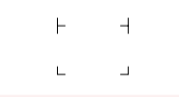

uni0358 0358

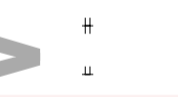

uni0355 0355

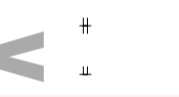

uni0354 0354



uni0357 0357

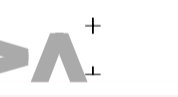

uni0356 0356



uni0351 0351



uni0350 0350

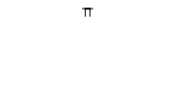

uni0353 0353

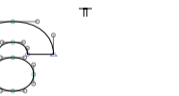

uni0352 0352

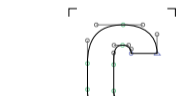

glottalstopreversedmod 02C1



uni035E 035E

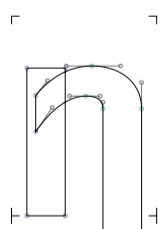

uni0220 0220

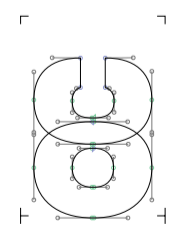

uni0223 0223



uni035F 035F



uni035C 035C

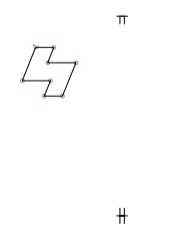

uni035B 035B

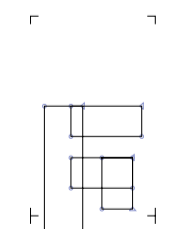

digamma 03DD

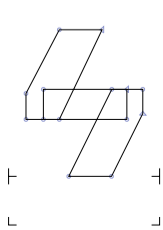

koppa 03DF



ringhalfrightcentered 02D2

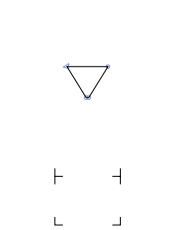

colontriangularhalfmod 02D1

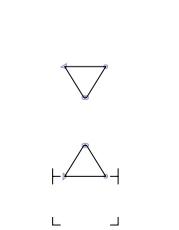

colontriangularmod 02D0

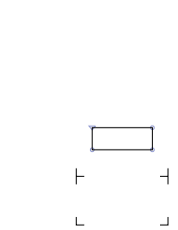

minusmod 02D7

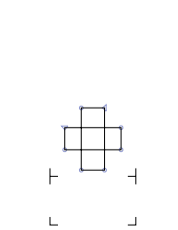

plusmod 02D6

down tack mod 02D5	line vert nosp 030D	esh loop prev 01AA	vertical bar dbl 2016	roman eleven 216A	lota 1 0196
uni A69F A69F	lsquare 2113	rho tick hook mod 02DE	uni 1DD6 1DD6	uni 1DD7 1DD7	line vert sub nosp 0329
mcapture 019C	uni 205D 205D	space open box 2423	uni 034B 034B	uni 034C 034C	uni 034A 034A
uni 034F 034F	uni 034D 034D	uni 034E 034E	uni 0348 0348	uni 0349 0349	peris pomeni greek cmb 0342
koroni scmb 0343	uni 0347 0347	uni 0238 0238	uni 0239 0239	tack down sub nosp 031E	uni 02EA 02EA
uni 02EB 02EB	uni 2071.ccmp	uni 02ED 02ED	uni 02EF 02EF	glottal stop reversed numr 02E4	afi 61664 200C
uni 1DC6 1DC6	uni 1DC4 1DC4	baby gamma 0264	Vcursive 0182	wynn 018F	reference mark 203B
over score nosp 0305	versicle 2123	hyphen _ 2010	diaeresis tonos nosp 0344	stigma 03DB	afi 57596 200E
afi 57598 200D	uni 2B4E 2B4E	uni 2B4F 2B4F	rturn ascend 027A	roman five hundred 216E	caret 2038

					
caretinsertionpoint 2041	bridgesubnosp 032A	uni0242 0242	uni0241 0241	uni0245 0245	uni02F9 02F9
					
uni02F8 02F8	uni02F5 02F5	uni02F4 02F4	uni02F7 02F7	uni02F6 02F6	uni02F1 02F1
					
uni02F0 02F0	uni02F3 02F3	uni02F2 02F2	dotmacroncomb.lc	uni02FE 02FE	uni02FD 02FD
					
uni02FF 02FF	uni02FA 02FA	uni02FC 02FC	uni02FB 02FB	angstrom 212B	macrongravecomb.lc
					
macronsubnosp 0331	ringlefthalfsubnosp 031C	Lsmallcap 029F	squaresubnosp 033B	Schwa 018F	uni2B5B 2B5B
					
uni2B5C 2B5C	uni2B5A 2B5A	uni2B5F 2B5F	uni2B5D 2B5D	uni2B5E 2B5E	oi 01A3
					
finalmem 02AD	Gsmallcap 0262	Esh 01A9	dierisismacroncomb.lc	Rsmallcapinv 0281	zerowidthjoiner FEFF
					
ts 02A6	tonesix 0185	uni1F16B 1F16B	pisybolgreek 03D6	uni1F16A 1F16A	dierisigravecomb.lc
					
tonefive 01BD	tel 2121	commasuprevnosp 0314	hyphennobreak 2011	archdblsubnosp 032B	deltaturn 018D

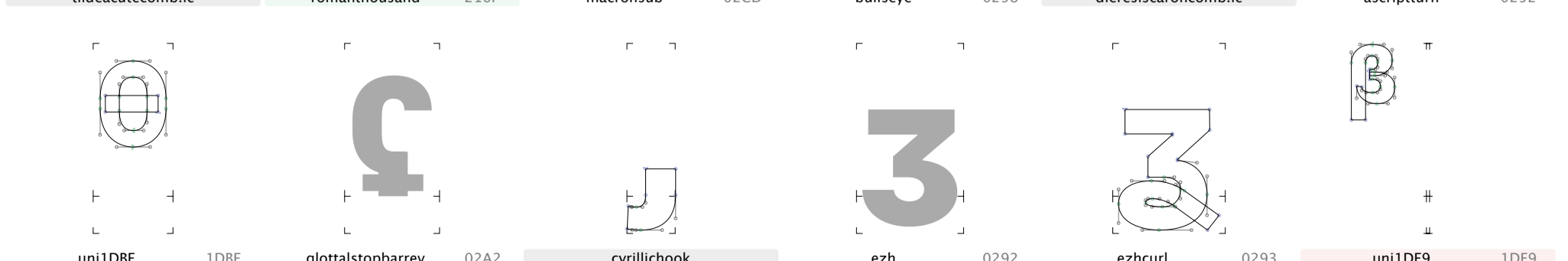
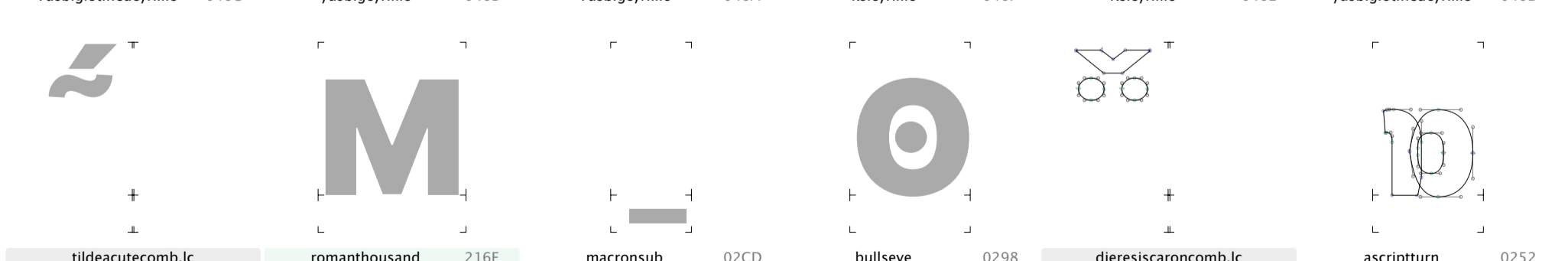
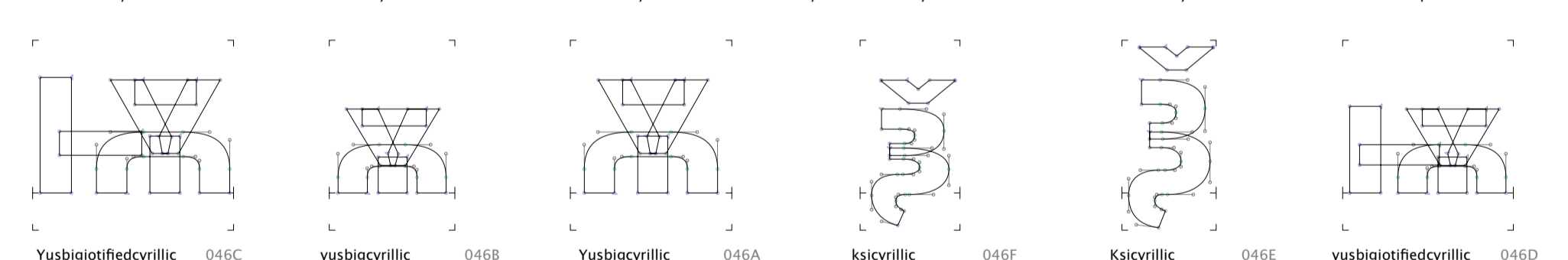
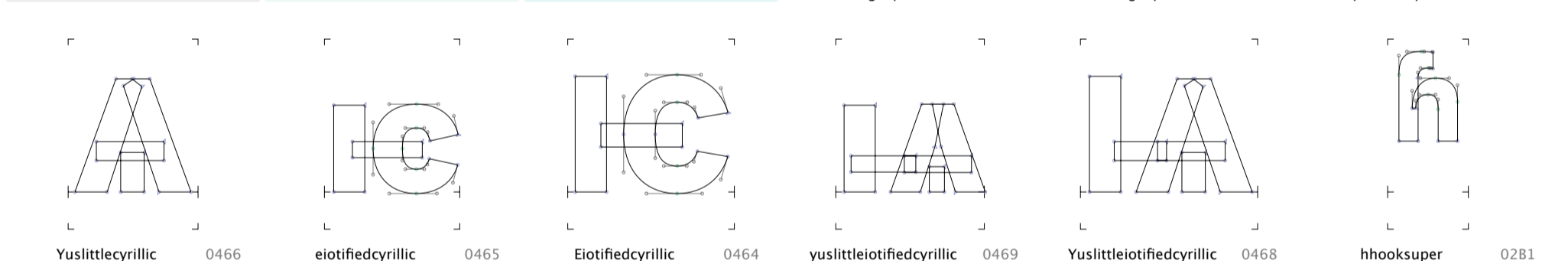
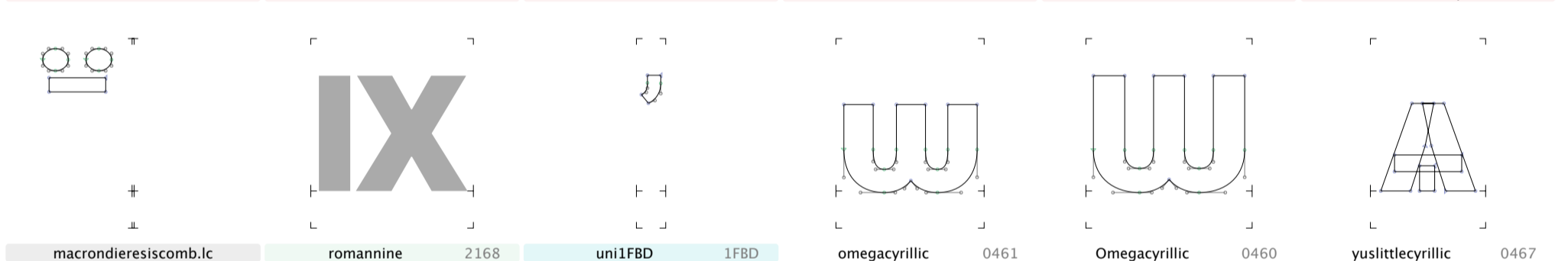
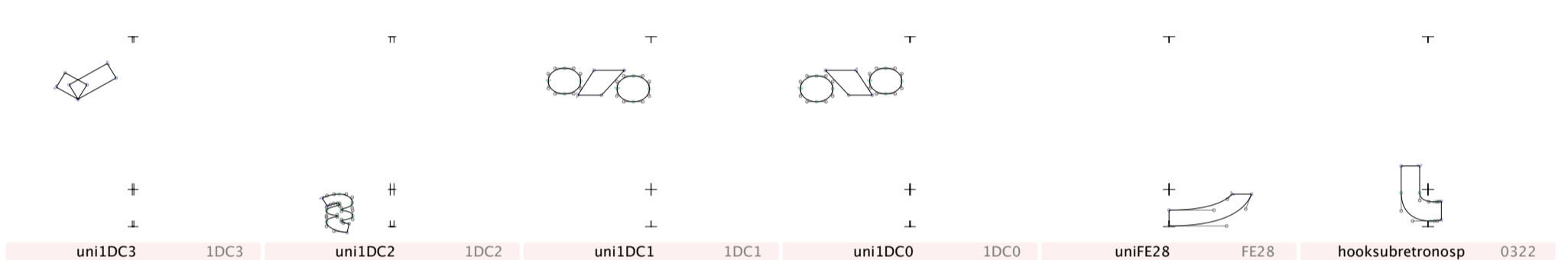
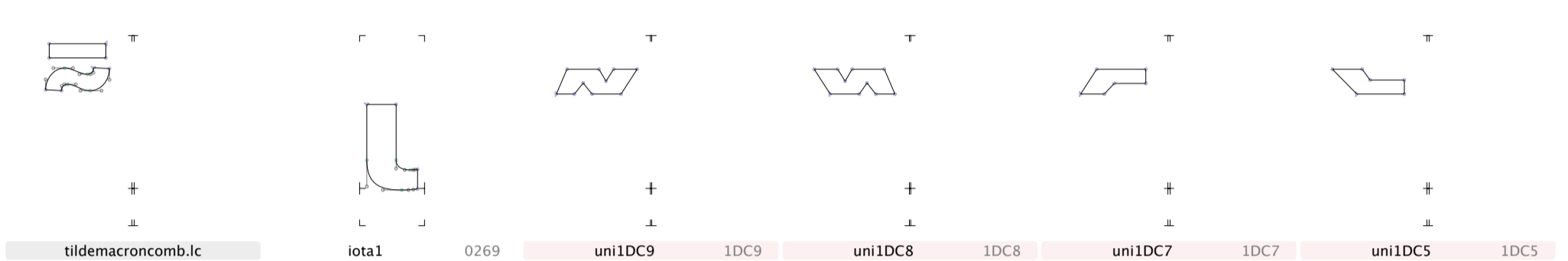
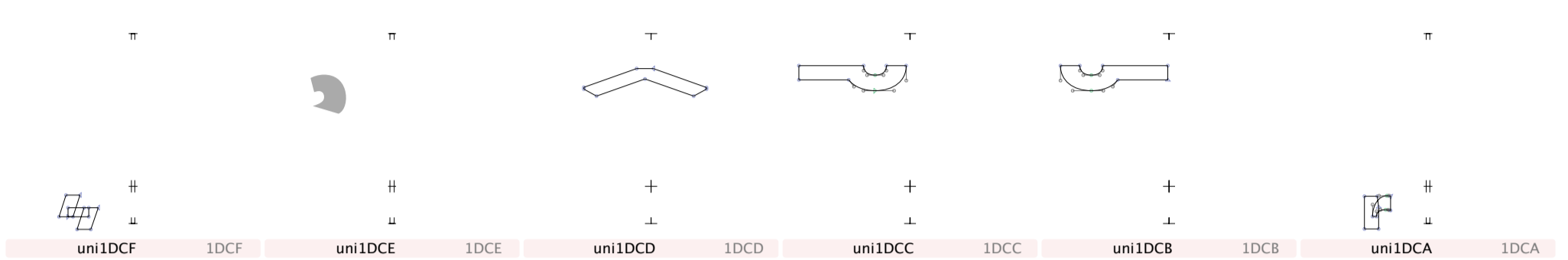
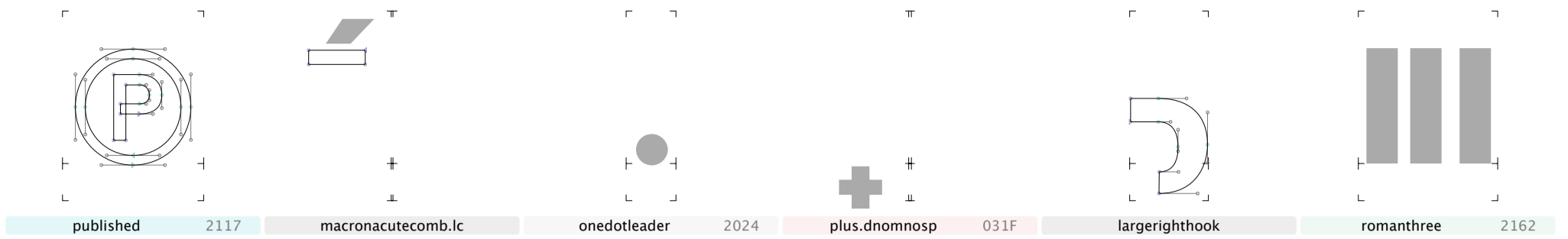

numeralgreek 0374	Omegaroundcyrillic 047A	omegaroundcyrillic 047B	Omegatitlocyrillic 047C	omegatitlocyrillic 047D	Otcyrillic 047E
otcyrillic 047F	gcursive 0261	uni035D 035D	uni035A 035A	quotedblreversed 201F	Rturnsuper 0286
uni1FCE 1FCE	uni1FCF 1FCF	upsilonlatin 028A	uni1FC1 1FC1	uni1FC0 1FC0	ringhalfleftcentered 02D3
omegaclosed 0277	uni1DE2 1DE2	OI 01A2	xsupnosp 033D	sampi 03E1	eshshortrev 0285
ounce 2125	vscript 0288	acuterightnosp 0341	barmidlongnosp 0336	tildevertsupnosp 033E	linevertdblnosp 030E
jhookdblbar 0284	overline 203E	ascript 0251	uni03CF 03CF	uni20DC 20DC	uni20DB 20DB
romansix 2165	uni1FBF 1FBF	uni1FBE 1FBE	ypogegrammeni 037A	romaneight 2167	charactertie 2040
Stigma 03DA	Epsilon1 0190	iotasubnosp 0345	pipedblbar 01C2	YR 01A6	kgreenlandic 0138
uni2182 2182	uni2180 2180	uni2181 2181	uni2186 2186	uni2187 2187	uni2184 2184

					
uni2185 2185	uni2188 2188	uni0222 0222	romanseven 2166	romanhundred 216D	uni1FEE 1FEE
					
uni1FED 1FED	graveleftnosp 0340	uniA7FF A7FF	tackleftsubnosp 0318	eurocurrency 20A0	uni20E8 20E8
					
rho1 03F1	uni20E3 20E3	dblapostrophe 02EE	glottalstopbar 02A1	minus.dnomnosp 0320	rturnsuper 02B4
					
linevert 02C8	uni217F 217F	uni217E 217E	uni217D 217D	uni217C 217C	twelveroman 217B
					
elevenroman 217A	lambdabar 019B	pipe 01C0	tenroman 2179	nineroman 2178	eightroman 2177
					
sevenroman 2176	fiveroman 2174	fourroman 2173	threeroman 2172	tworoman 2171	oneroman 2170
					
underscoredblno 0333	tackrightsubnosp 0319	Sampi 03E0	schwa 0259	uni1DDA 1DDA	koppacyrillic 0481
					
Koppacyrillic 0480	titlocyrlilicmb 0483	thousandcyrillic 0482	dasiapneumatacyrilliccmb 0485	palatalizationcyrilliccmb 0484	uni0487 0487
					
psilipneumatacyrilliccmb 0486	uni0489 0489	uni0488 0488	uni20F0 20F0	eshcurl 0286	quotereversed 201B

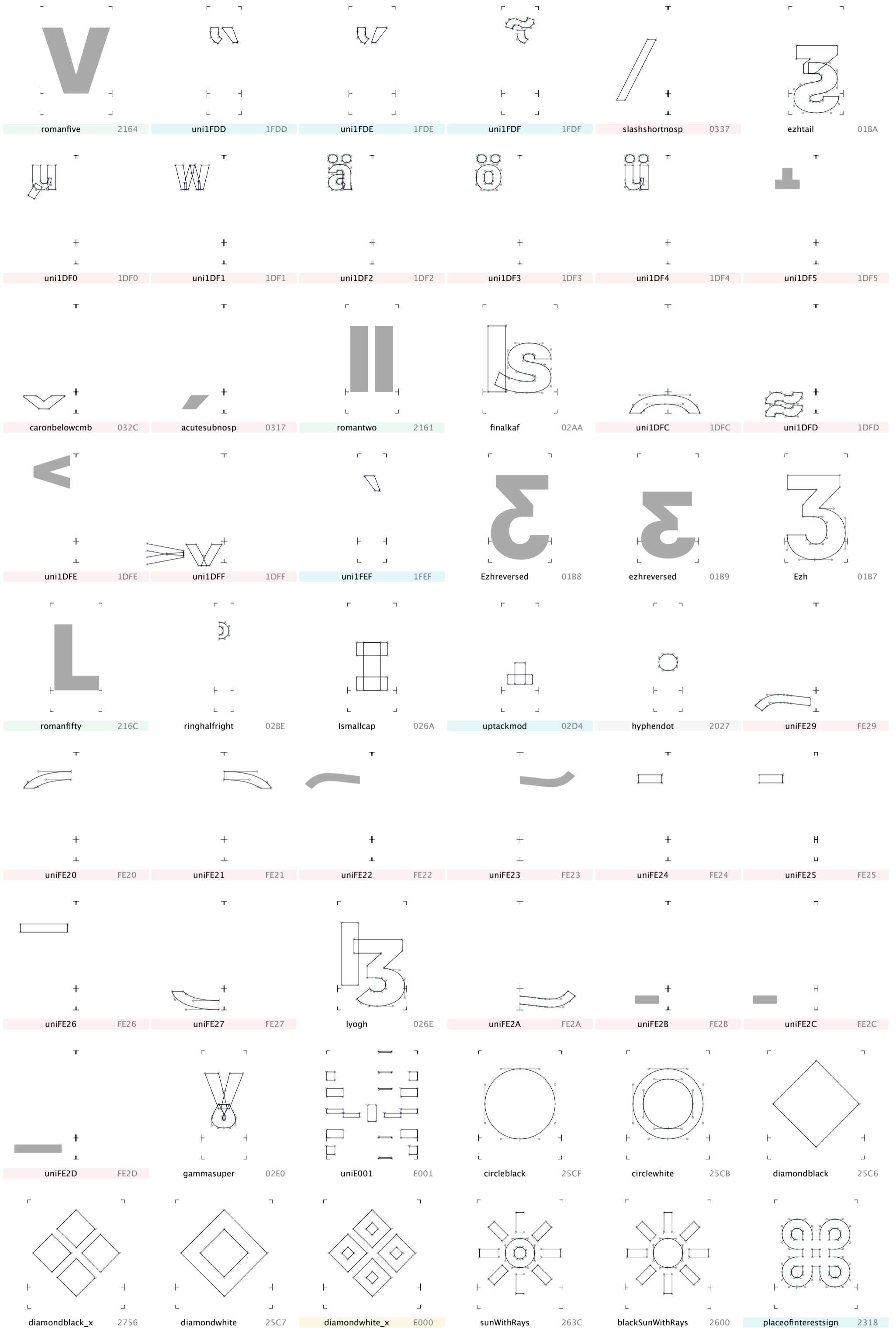

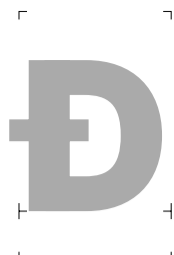

Eth 00D0



Dcroat 0110



IJ 0132



Ldot 013F



Tbar 0166

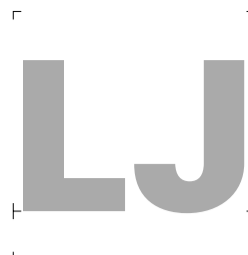

LJ 01C7



NJ 01CA



DZ 01F1



Aogonek.NAV



Eogonek.NAV

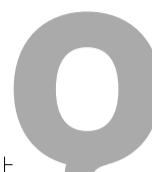

Oogonek.NAV



uni03F7 03F7



afi10020 0413



afi10052 0403



afi10033 041F



afi10034 0420



afi10035 0421



afi10036 0422



afi10039 0425



afi10146 0462



Psycyrillic 0470



Ukcyrillic 0478



uni048C 048C



Ghestrokecyrillic 0492



Zedescendercyrillic 0498



Esdescendercyrillic 04AA

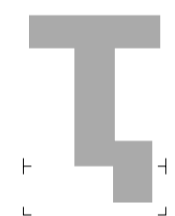

Tedescendercyrillic 04AC



Ustraightcyrillic 04AE



Ustraightstrokecyrillic 04B0



Chedescenderabkhasiancyrillic 04BE



palochkacyrillic 04C0



Chekhakassiancyrillic 04CB

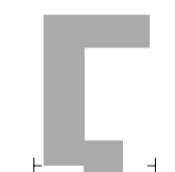

uni04F6 04F6



uni04FE 04FE



afi10061 040C



Schwadiesiscyrillic 04DA



Zhebrevecyrillic 04C1



Zhedieresiscyrillic 04DC



Zedieresiscyrillic 04DE



afi10062 040E



Umacroncyrillic 04EE



Udieresiscyrillic 04F0



Uhungarumlautcyrillic 04F2



Chedieresiscyrillic 04F4



Yerudieresiscyrillic 04F8



uni04EC 04EC



Izhitsadblgravecyrillic 0476



uni0299 0299



uni029C 029C



aogonek.NAV



eogonek.NAV



oogonek.NAV



kappa 03BA



mugreek 03BC

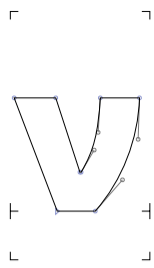

nu 03BD



uni03F8 03F8



uni1F71 1F71



uni1F73 1F73



uni1F75 1F75



uni1F77 1F77

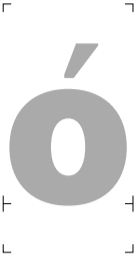

uni1F79 1F79

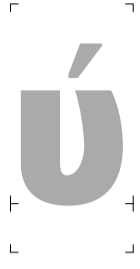

uni1F7B 1F7B



uni1F7D 1F7D



uni1FD3 1FD3



uni1FE3 1FE3

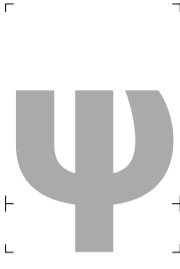

psicrillic 0471



ghestrokecyrillic 0493



zedescendercyrillic 0499



esdescendercyrillic 04AB

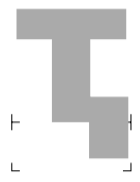

tedescendercyrillic 04AD

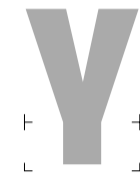

ustraightcyrillic 04AF



ustraightstrokecyrillic 04B1



chedescenderabkhasiancyril 04BF



chekhakassiancyrillic 04CC



schwacyrillic 04D9



schwadiesiscyrillic 04DB



obarredcyrillic 04E9



obarreddiesiscyrillic 04EB



uni04F7 04F7



uni04FF 04FF



chedieresiscyrillic 04F5



uni04ED 04ED



gjecyrillic 0453



iishortcyrillic 0439



uni045D 045D



imacroncyrillic 04E3



idieresiscyrillic 04E5



izhitsadblgravecyrillic 0477



kjecyrillic 045C



yerudieresiscyrillic 04F9



zedieresiscyrillic 04DF



zhebrevcyrillic 04C2



zhedieresiscyrillic 04DD



Ezhcaron 01EE

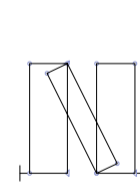

Nsmallcap 0274

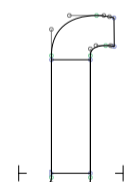

esh 0283



ezhcaron 01EF

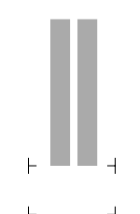

pipedbl 01C1

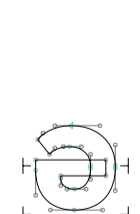

uni2094 2094

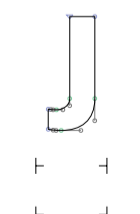

uni02B2.ccmp



Eltail-cy 04C5

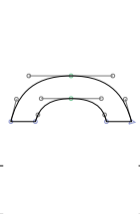

uniA92E A92E

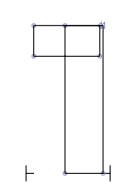

tonebarextrahighmod.cn 02E5

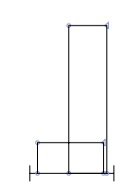

tonebarextralowmod.cn 02E9

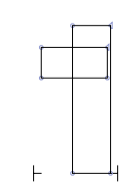

tonebarhighmod.cn 02E6

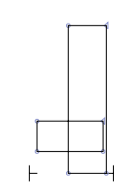

tonebarlowmod.cn 02E8

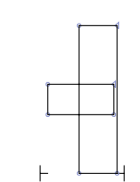

tonebarmidmod.cn 02E7



commaabovecmb 0313

commaaboverightcmb 0315	hooksubpalatnosp 0321	bridgeinvsubnosp 033A	uni1DE7 1DE7	uni1DE8 1DE8	uni1DEA 1DEA

uni1DEB 1DEB	uni1DEC 1DEC	uni1DED 1DED	uni1DEE 1DEE	uni1DEF 1DEF	macronacutecomb.cn

macrongravecomb.cn	uni1FFE.tonos	uni1FCD.tonos	uni1FDD.tonos	uni1FCE.tonos	uni1FDE.tonos

uni1FCF.tonos	uni1FDF.tonos	uni1FEF.tonos	uni1FFD.tonos	uni1DE0 1DE0	uni1DE1 1DE1

uni1DE3 1DE3	uni1DE4 1DE4	uni1DE5 1DE5	uni1DE6 1DE6	cyrillictic.cn	controlHT

controlSOT	commaaccentright.cn	ringacute.cn	circumflexgravecomb.cn	dieresisacaroncomb.cn	dieresismacroncomb.cn

carondotcomb.cn	breveacutecomb.cn	acutedotcomb.cn	brevegravecomb.cn	circumflexacutecomb.cn	tildedieresiscomb.cn

circumflexhookcomb.cn	brevetildecomb.cn	dieresisacutecomb.cn	dotmacroncomb.cn	macrondieresiscomb.cn	dieresisgravecomb.cn

tildemacroncomb.cn	circumflextildecomb.cn	brevehookcomb.cn	commaaccentrotate.cn	tildeacutecomb.cn	tonostop



cyrillictail.cn

koronisaccentleft.cn