

A 0041



Adieresis 00C4



Atilde 00C3



Agrave 00C0



Acute 00C1



Acircumflex 00C2



Aring 00C5



Amacron 0100



Abreve 0102



Aogonek 0104



Acaron 01CD



Adieresismacron 01DE



Adotmacron 01E0



Aringacute 01FA



Adblgrave 0200



Ainvertedbreve 0202



uni0226 0226



Aringbelow 1E00



Adotbelow 1EA0



Ahookabove 1EA2



Acircumflexacute 1EA4



Acircumflexgrave 1EA6



Acircumflexhookabove 1EA8



Acircumflextilde 1EAA



Acircumflexdotbelow 1EAC



Abreveacute 1EAE



Abrevegrave 1EB0



Abrevehookabove 1EB2



Abrevetilde 1EB4



Abrevedotbelow 1EB6



Alpha 0391



Alphatonos 0386



uni1F08 1F08



uni1F09 1F09



uni1F0A 1F0A



uni1F0B 1F0B



uni1F0C 1F0C



uni1F0D 1F0D



uni1F0E 1F0E



uni1F0F 1F0F

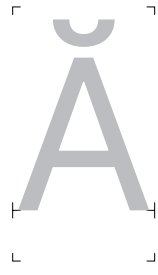

uni1FB8 1FB8



uni1FB9 1FB9



uni1FBA 1FBA

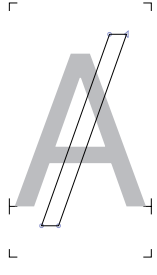

uni023A 023A



uni1FBB 1FBB



afi10017 0410



Abrevecyrillic 04D0



Adieresiscyrillic 04D2



uni1F88 1F88



uni1F89 1F89



uni1F8A 1F8A



uni1F8B 1F8B



uni1F8C 1F8C



uni1F8D 1F8D



uni1F8E 1F8E



uni1F8F 1F8F



uni1FBC 1FBC

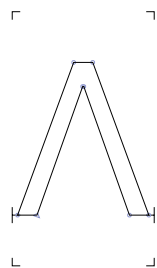

Lambda 039B

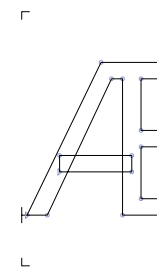

AE 00C6



AEmacron 01E2



AEacute 01FC



Aicyrillic 04D4

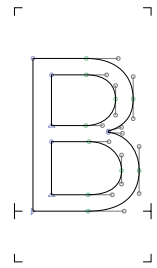

B 0042



Bdotaccent 1E02



Bdotbelow 1E04



Blinebelow 1E06



uni0243 0243

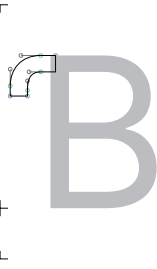

Bhook 0181



afii10019 0412



Beta 0392

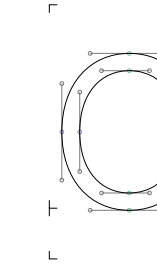

C 0043

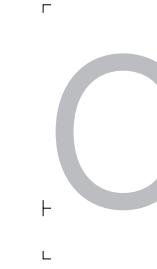

Chook 0187



Ccedilla 00C7



Cacute 0106



Ccircumflex 0108



Cdotaccent 010A



Ccaron 010C



Ccedillaacute 1E08

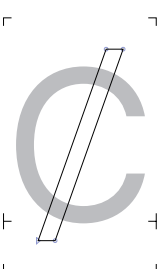

uni023B 023B

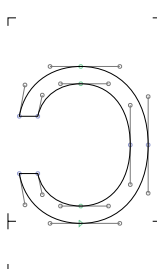

Oopen 0186



uni03F9 03F9

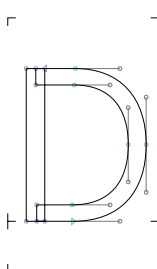

D 0044

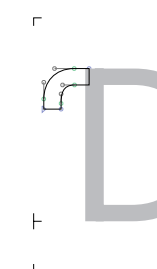

Dhook 018A



Dcaron 010E



Ddotaccent 1E0A



Ddotbelow 1E0C



Dlinebelow 1E0E



Dcedilla 1E10



Dcircumflexbelow 1E12



Dbar1 0189



Dz 01F2



Dzcaron_ 01C5

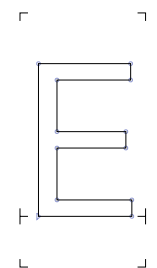

E 0045



Egrave 00C8



Eacute 00C9



Ecircumflex 00CA



Eadieresis 00CB



Emacron 0112



Ebreve 0114



Edotaccent 0116



Eogonek 0118



Ecaron 011A



Edblgrave 0204



Einvertedbreve 0206



uni0228 0228



Emacrongrave 1E14



Emacronacute 1E16



Ecircumflexbelow 1E18

Etildebelow 1E1A Ecedillabreve 1E1C Edotbelow 1EB8 Ehookabove 1EBA Etilde 1EBC Ecircumflexacute 1EBE

Ecircumflexgrave 1EC0 Ecircumflexhookabove 1EC2 Ecircumflextilde 1EC4 Ecircumflexdotbelow 1EC6 uni0246 0246 Eturn 018E

Epsilon 0395 Epsilontonos 0388 uni1F18 1F18 uni1F19 1F19 uni1F1A 1F1A uni1F1B 1F1B

uni1F1C 1F1C uni1F1D 1F1D uni1FC8 1FC8 uni1FC9 1FC9 afii10022 0415 uni0400 0400

afii10023 0401 lebrevecyrillic 04D6 F 0046 Fhook 0191 Fdotaccent 1E1E Fturn 2132

G 0047 Gbar 01E4 Ghook 0193 Gcircumflex 011C Gbreve 011E Gdotaccent 0120

Gcommaaccent 0122 Gcaron 01E6 Gacute 01F4 Gmacron 1E20 G.1 Gbar.1

Ghook.1 Gcircumflex.1 Gbreve.1 Gdotaccent.1 Gcommaaccent.1 Gcaron.1

Gacute.1 Gmacron.1 H 0048 Hcedilla 1E28 Hcircumflex 0124 uni021E 021E



Hdotaccent 1E22



Hdotbelow 1E24



Hdieresis 1E26



Hbrevebelow 1E2A

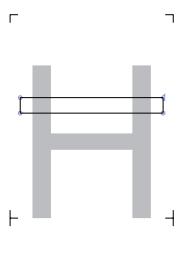

Hbar 0126



Enhookcyrillic 04C7

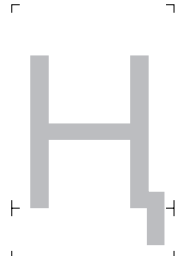

Endescendercyrillic 04A2



uni04C9 04C9

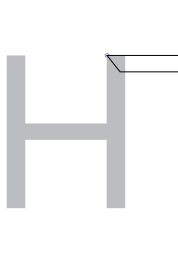

Enghecyrillic 04A4

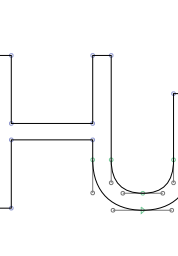

uni01F6 01F6



Eta 0397



Etatonos 0389



uni1F28 1F28



uni1F29 1F29



uni1F2A 1F2A



uni1F2B 1F2B



uni1F2C 1F2C



uni1F2D 1F2D



uni1F2E 1F2E



uni1F2F 1F2F



uni1FCA 1FCA



uni1FCB 1FCB



afi10031 041D



uni1F98 1F98



uni1F99 1F99



uni1F9A 1F9A



uni1F9B 1F9B



uni1F9C 1F9C



uni1F9D 1F9D



uni1F9E 1F9E



uni1F9F 1F9F



uni1FCC 1FCC

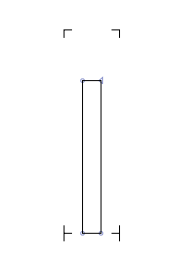

I 0049



Idieresis 00CF



Idieresisacute 1E2E



Istroke 0197

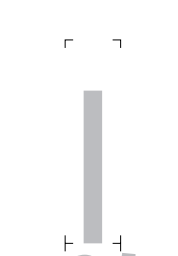

Itildebelow 1E2C

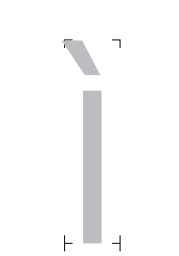

Igrave 00CC

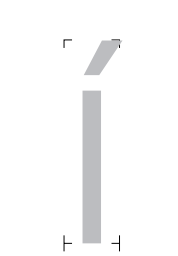

Iacute 00CD

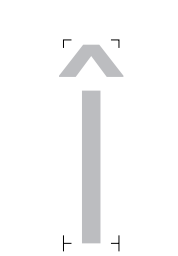

Icircumflex 00CE



Itilde 0128

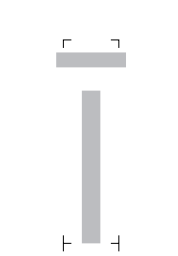

I macron 012A



I breve 012C

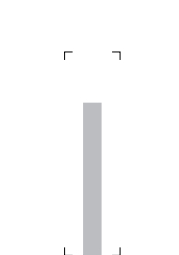

I logonek 012E

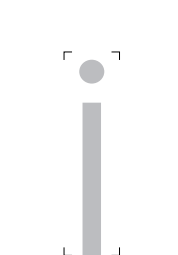

I dotaccent 0130

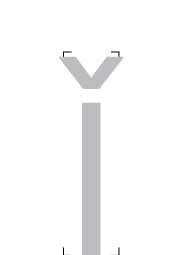

I caron 01CF

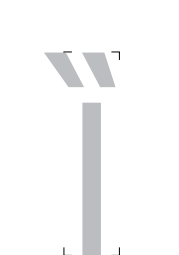

I double grave 0208



I inverted breve 020A

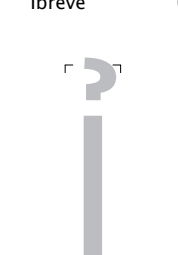

I hookabove 1E28

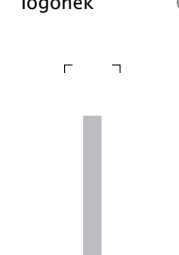

I dotbelow 1E2A

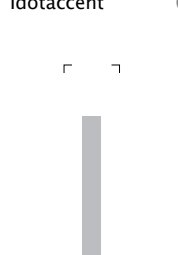

Iota 0399



Iota tonos 038A

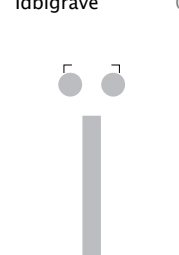

Iota dieresis 03AA



uni1F38 1F38

uni1F39 1F39 uni1F3A 1F3A uni1F3B 1F3B uni1F3C 1F3C uni1F3D 1F3D uni1F3E 1F3E

uni1F3F 1F3F uni1FD8 1FD8 uni1FD9 1FD9 uni1FDA 1FDA uni1FDB 1FDB afii10055 0406

afii10056 0407 l.1 ldieresis.1 ldieresisacute.1 lstroke.1 ltildebelow.1

lgrave.1 lacute.1 lcircumflex.1 ltilde.1 lmacron.1 lbreve.1

logonek.1 ldotaccent.1 lcaron.1 ldblgrave.1 llnvertedbreve.1 lhookabove.1

ldotbelow.1 uni1F38.1 uni1F39.1 uni1F3A.1 uni1F3B.1 uni1F3C.1

uni1F3D.1 uni1F3E.1 uni1F3F.1 uni1FD8.1 uni1FD9.1 uni1FDA.1

uni1FDB.1 afii10055.1 afii10056.1 J 004A Jcircumflex 0134 uni0248 0248

uni037F 037F afii10057 0408 K 004B Kcommaaccent 0136 Kcaron 01E8 Kacute 1E30

					
Kdotbelow 1E32	Klinebelow 1E34	Kabashkircyrillic 04A0	Kadescendcyrillic 049A	Khook 0198	Kappa 039A
					
L 004C	Lacute 0139	Lcommaaccent 013B	Lcaron 013D	Ldotbelow 1E36	Ldotbelowmacron 1E38
					
Llinebelow 1E3A	Lcircumflexbelow 1E3C	Lslash 0141	Lbar 023D	Lj 01C8	M 004D
					
Macute 1E3E	Mdotaccent 1E40	Mdotbelow 1E42	uni04CD 04CD	Mu 039C	uni03FA 03FA
					
afii10030 041C	N 004E	Ntilde 00D1	Nacute 0143	Ncommaaccent 0145	Ncaron 0147
					
uni01F8 01F8	Ndotaccent 1E44	Ndotbelow 1E46	Nlinebelow 1E48	Ncircumflexbelow 1E4A	Nhook 019D
					
Eng 014A	afii10026 0418	uni040D 040D	afii10027 0419	Imacroncyrillic 04E2	Idierescyrillic 04E4
					
uni048A 048A	uni0376 0376	Nu 039D	Nj 01CB	O 004F	Odieresis 00D6
					
Otilde 00D5	Oslash 00D8	Ohorn 01A0	Ograve 00D2	Oacute 00D3	Ocircumflex 00D4

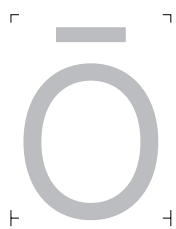

Omacron 014C

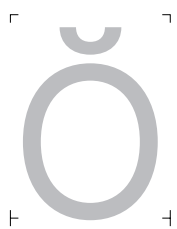

Obreve 014E



Ohungarumlaut 0150



Ocaron 01D1

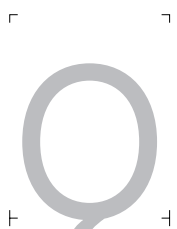

Oogonek 01EA

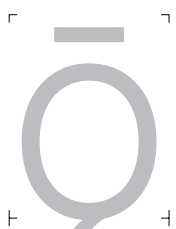

Oogonekmacron 01EC

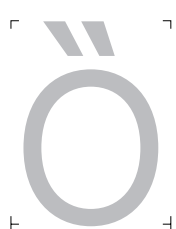

Odblgrave 020C

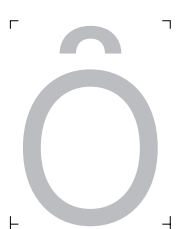

Oinvertedbreve 020E

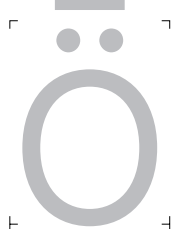

uni022A 022A

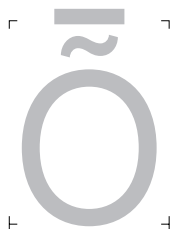

uni022C 022C

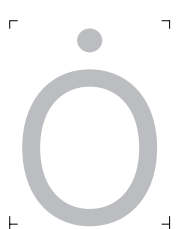

uni022E 022E

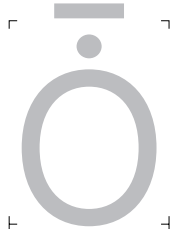

uni0230 0230



Otildeacute 1E4C



Otildedieresis 1E4E

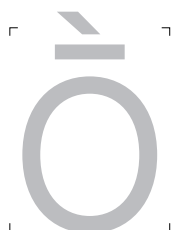

Omacrongrave 1E50

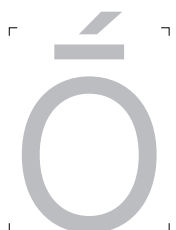

Omacronacute 1E52

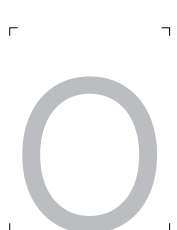

Odotbelow 1ECC

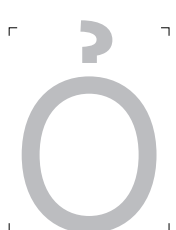

Ohookabove 1ECE

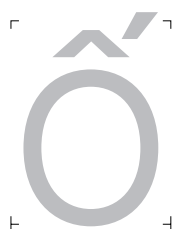

Ocircumflexacute 1ED0

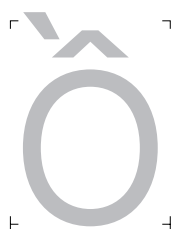

Ocircumflexgrave 1ED2

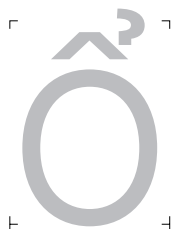

Ocircumflexhookabove 1ED4

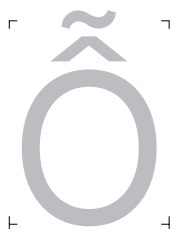

Ocircumflextilde 1ED6

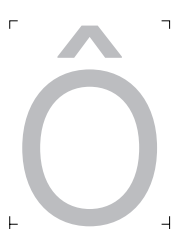

Ocircumflexdotbelow 1ED8



Ohornacute 1EDA



Ohorngrave 1EDC



Ohornhookabove 1EDE



Ohorntilde 1EE0



Ohorndotbelow 1EE2



Oslashacute 01FE

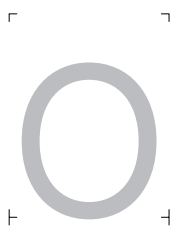

Omicron 039F

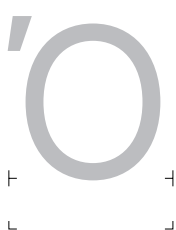

Omicrontonos 038C

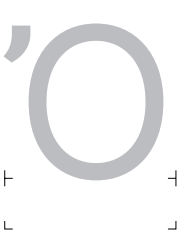

uni1F48 1F48



uni1F49 1F49



uni1F4A 1F4A



uni1F4B 1F4B



uni1F4C 1F4C



uni1F4D 1F4D



uni1FF8 1FF8



uni03F4 03F4

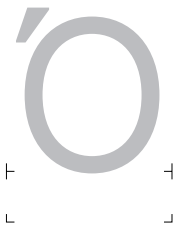

uni1FF9 1FF9

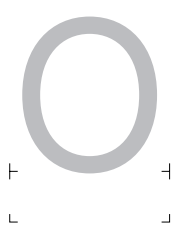

afi10032 041E

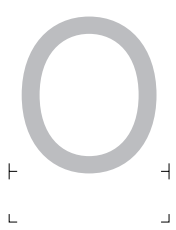

Odiereiscyrillic 04E6

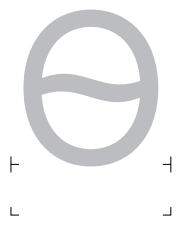

Obar 019F

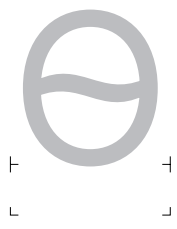

Obarredcyrillic 04E8

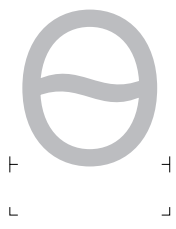

Obarreddieriscyrillic 04EA

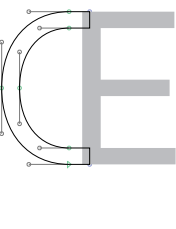

OE 0152

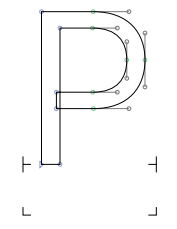

P 0050



Pacute 1E54



Pdotaccent 1E56

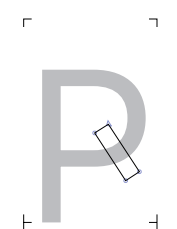

uni048E 048E

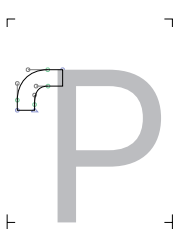

Phook 01A4



Rho 03A1



uni1FEC 1FEC

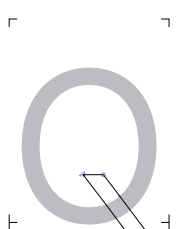

Q 0051

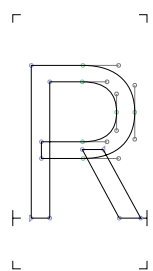

R 0052



Racute 0154



Rcommaaccent 0156



Rcaron 0158



Rdblgrave 0210



Rinvertedbreve 0212



Rdotaccent 1E58



Rdotbelow 1E5A



Rdotbelowmacron 1E5C



Rlinebelow 1E5E



response 211F

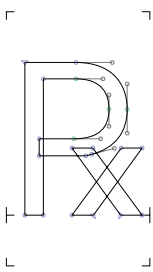

Rx 211E

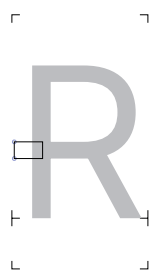

uni024C 024C

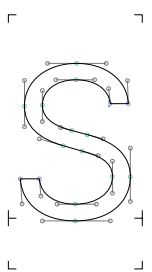

S 0053



Sacute 015A



Scircumflex 015C



Scedilla 015E



Scaron 0160



Scommaaccent 0218



Sdotaccent 1E60



Sdotbelow 1E62



Sacutedotaccent 1E64



Scaronodotaccent 1E66



Sdotbelowdotaccent 1E68



afii10054 0405



Tonetwo 01A7

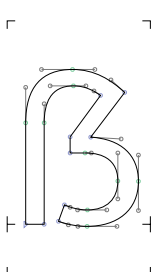

Germandbls 1E9E

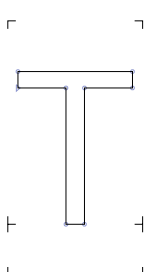

T 0054



Tcommaaccent 0162



Tcaron 0164



uni021A 021A



Tdotaccent 1E6A



Tdotbelow 1E6C



Tlinebelow 1E6E



Tcircumflexbelow 1E70

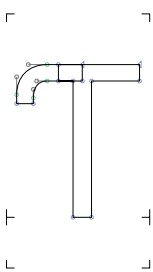

Thook 01AC



Trthook 01AE

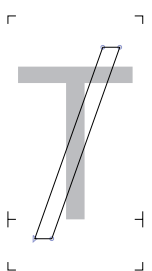

uni023E 023E



Tau 03A4

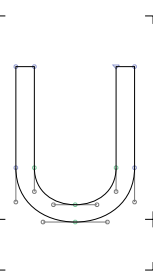

U 0055

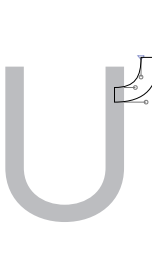

Uhorn 01AF



Ugrave 00D9



Uacute 00DA



Ucircumflex 00DB



Udieresis 00DC



Utilde 0168



Umacron 016A



Ubreve 016C



Uring 016E



Uhungarumlaut 0170



Uogonek 0172



Ucaron 01D3



Udieresismacron 01D5



Udieresisacute 01D7

					
Udieresiscaron 01D9	Udieresisgrave 01DB	Udblgrave 0214	Uinvertedbreve 0216	Udieresisbelow 1E72	Utildebelow 1E74
					
Ucircumflexbelow 1E76	Utildeacute 1E78	Umacrondieresis 1E7A	Udotbelow 1EE4	Uhookabove 1EE6	Uhornacute 1EE8
					
Uhorngrave 1EEA	Uhornhookabove 1EEC	Uhorntilde 1EEE	Uhorndotbelow 1EF0	uni0244 0244	V 0056
					
Vtilde 1E7C	Vdotbelow 1E7E	W 0057	Wcircumflex 0174	Wgrave 1E80	Wacute 1E82
					
Wdieresis 1E84	Wdotaccent 1E86	Wdotbelow 1E88	X 0058	Xdotaccent 1E8A	Xdieresis 1E8C
					
Hascendercyrillic 04B2	uni04FC 04FC	Chi 03A7	Y 0059	Yhook 01B3	Yacute 00DD
					
Ycircumflex 0176	Ydieresis 0178	uni0232 0232	Ydotaccent 1E8E	Ygrave 1EF2	Ydotbelow 1EF4
					
Yhookabove 1EF6	Ytilde 1EF8	uni024E 024E	Upsilon 03A5	Upsilontonos 038E	Upsilondieresis 03AB
					
uni1F59 1F59	uni1F5B 1F5B	uni1F5D 1F5D	uni1F5F 1F5F	uni1FE8 1FE8	uni1FE9 1FE9

uni1FEA 1FEA	uni1FEB 1FEB	Z 005A	Zacute 0179	Zdotaccent 017B	Zcaron 017D
Zcircumflex 1E90	Zdotbelow 1E92	Zlinebelow 1E94	uni0224 0224	Zbar 01B5	Zeta 0396
uni2C7F 2C7F	a 0061	aacute 00E1	abreve 0103	abreveacute 1EAF	abrevedotbelow 1EB7
abrevegrave 1EB1	abrevehookabove 1EB3	abrevetilde 1EB5	acaron 01CE	acircumflex 00E2	acircumflexacute 1EA5
acircumflexdotbelow 1EAD	acircumflexgrave 1EA7	acircumflexhookabove 1EA9	acircumflextilde 1EAB	addgrave 0201	adieresis 00E4
adieresismacron 01DF	uni0227 0227	adotbelow 1EA1	adotmacron 01E1	agrave 00E0	ahookabove 1EA3
ainvertedbreve 0203	amacron 0101	aogonek 0105	arighthalfring 1E9A	aring 00E5	aringacute 01FB
aringbelow 1E01	atilde 00E3	aturn 0250	afii10065 0430	abrevecyrillic 04D1	adieresiscyrillic 04D3
ae 00E6	aemacron 01E3	aeacute 01FD	aiecyrillic 04D5	a.1	aacute.1

abreve.1

abreveacute.1

abrevedotbelow.1

abrevegrave.1

abrevehookabove.1

abrevetilde.1

acaron.1

acircumflex.1

acircumflexacute.1

acircumflexdotbelow.1

acircumflexgrave.1

acircumflexhookabove.1

acircumflextilde.1

adblgrave.1

adieresis.1

adieresismacron.1

uni0227.1

adotbelow.1

adotmacron.1

agrave.1

ahookabove.1

ainvertedbreve.1

amacron.1

aogonek.1

arighthalfring.1

aring.1

aringacute.1

aringbelow.1

atilde.1

b

0062

bbar

0180

btopbar

0183

bhook

0253

bdotaccent

1E03

bdotbelow

1E05

blinebelow

1E07

c

0063

uni023C

023C

chook

0188

ccurl

0255

ccedilla

00E7

cacute

0107

ccircumflex

0109

ccdotaccent

010B

ccaron

010D

ccedillaacute

1E09

sigmalunatesymbolgreek

03F2

escyrillic

0441

d

0064

dcroat

0111

drthook

0256

dhook

0257

dtopbar

018C

uni0221

0221

d' 010F d̈ 1E0B ḋ 1E0D d̄ 1E0F d̸ 1E11 d̡ 1E13

dz 02A3 dzcaron 01C6 dzcurl 02A5 dyogh 02A4 dong 20AB e 0065

ë 00EB uni0247 0247 è 00E8 é 00E9 ê 00EA ē 0113

ě 0115 è 0117 ę 0119 ě 011B è 0205 è 0207

uni0229 0229 emacrongrave 1E15 emacronacute 1E17 ecircumflexbelow 1E19 etildebelow 1E1B ecedillabreve 1E1D

ė 1EB9 ehookabove 1EBB etilde 1EBD ecircumflexacute 1EBF ecircumflexgrave 1EC1 ecircumflexhookabove 1EC3

ẽ 1EC5 ecircumflexdotbelow 1EC7 iecyrillic 0435 uni0450 0450 iocyrillic 0451 iebrevecyrillic 04D7

ə 01DD _part.f_base f 0066 slongstroke 1E9C slongdotaccent 1E9B fdotaccent 1E1F

fn̄ 02A9 g 0067 ghook 0260 ḡ 01E5 ĝ 011D ğ 011F

gdotaccent 0121	gcommaaccent 0123	gcaron 01E7	gacute 01F5	gmacron 1E21	h 0068
hcedilla 1E29	tshecyrillic 045B	djecyrillic 0452	hhook 0266	henghook 0267	hv 0195
hturn 0265	hturnlthook 02AE	hturnhook2 02AF	hbar 0127	hcircumflex 0125	uni021F 021F
hdotaccent 1E23	hdotbelow 1E25	hdieresis 1E27	hbrevbelow 1E2B	hlinebelow 1E96	shhacyrillic 04BB
i 0069	idotless 0131	idieresis 00EF	idieresisacute 1E2F	itilde 0129	itildebelow 1E2D
uni1E2D.ccmp	ibar 0268	igrave 00EC	iacute 00ED	icircumflex 00EE	imacron 012B
ibreve 012D	uni012F.ccmp	iogonek 012F	icaron 01D0	idblgrave 0209	iinvertedbreve 020B
ihookabove 1EC9	idotbelow 1ECB	uni1ECB.ccmp	jdotless 0237	jdotlessbar 025F	uni0249 0249
uni0249.ccmp	icyrillic 0456	yicyrillic 0457	ij 0133	j 006A	jcrosstail.ccmp

jrosstail 029D jcircumflex 0135 jcaron 01F0 yotgreek 03F3 jecyrillic 0458 lj 01C9

k 006B khook 0199 kcommaaccent 0137 kcaron 01E9 kacute 1E31 kdotbelow 1E33

klinebelow 1E35 kturn 029E l 006C lslash 0142 lbar 019A lmidtilde 026B

lrhook 026D lbelt 026C lcurl 0234 ldot 0140 lacute 013A lcommaaccent 013C

lcaron 013E ldotbelow 1E37 ldotbelowmacron 1E39 llinebelow 1E3B lcircumflexbelow 1E3D l.ss02

lslash.ss02 lbar.ss02 lmidtilde.ss02 lbelt.ss02 ldot.ss02 lacute.ss02

lcommaaccent.ss02 lcaron.ss02 ldotbelow.ss02 ldotbelowmacron.ss02 llinebelow.ss02 lcircumflexbelow.ss02

uni04CF 04CF m 006D mhook 0271 mturn 026F mturndescend 0270 macute 1E3F

mdotaccent 1E41 mdotbelow 1E43 n 006E ntilde 00F1 nrhook 0273 eng 014B

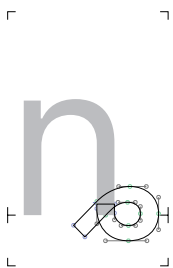

ncurl 0235



nlfthook 0272



nletrightlong 019E



nacute 0144



ncommaaccent 0146



ncaron 0148



uni01F9 01F9



ndotaccent 1E45



ndotbelow 1E47



nlinebelow 1E49



ncircumflexbelow 1E4B



nj 01CC

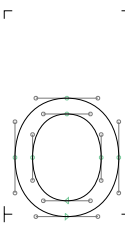

o 006F



odieresis 00F6



otilde 00F5

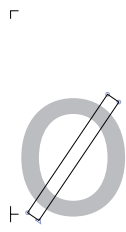

oslash 00F8

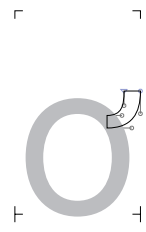

ohorn 01A1



ograve 00F2



oacute 00F3



ocircumflex 00F4



omacron 014D



obreve 014F



ohungarumlaut 0151



ocaron 01D2



oogonek 01EB



oogonekmacron 01ED



odblgrave 020D



oinvertedbreve 020F



uni022B 022B



uni022D 022D



uni022F 022F



uni0231 0231



otildeacute 1E4D



otildedieresis 1E4F



omacrongrave 1E51



omacronacute 1E53



odotbelow 1ECD



ohookabove 1ECF



ocircumflexacute 1ED1



ocircumflexgrave 1ED3



ocircumflexhookabove 1ED5



ocircumflextilde 1ED7



ocircumflexdotbelow 1ED9



ohornacute 1EDB



ohorngrave 1EDD



ohornhookabove 1EDF



ohorntilde 1EE1



ohorndotbelow 1EE3



oslashacute 01FF



omicron 03BF



omicrontonos 03CC



uni1F40 1F40



uni1F41 1F41



uni1F42 1F42

ö uni1F43 1F43 ö uni1F44 1F44 ö uni1F45 1F45 ò uni1F78 1F78 ø fitacyrillic 0473 ø obar 0275

o ocyrillic 043E ö odieresiscyrillic 04E7 œ oe 0153 oy ukcyrillic 0479 p p 0070 uni048F 048F

ḡ phook 01A5 ḡ pacute 1E55 ḡ pdotaccent 1E57 p ercyrillic 0440 q q 0071 q qhook 02A0

q qhook 024B Q_rthook 024A r r 0072 r rthook uni024D 024D r rturn 0279





















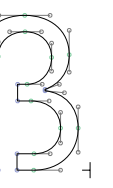

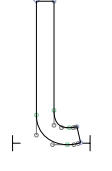
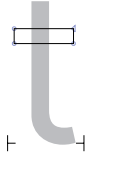

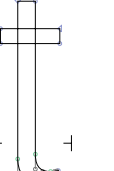
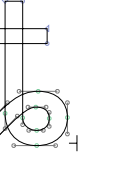

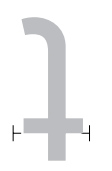
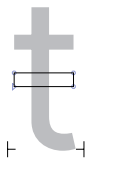







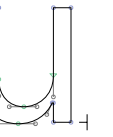



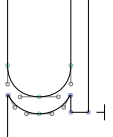









r rturnrthook 027B r rfishhookrev 027F r rfishhook 027E r rdescend uni024D 024D racute 0155 rcommaaccent 0157



















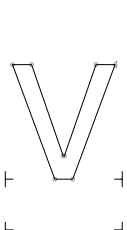



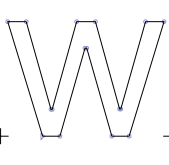







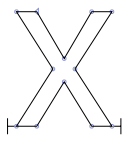

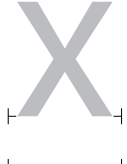
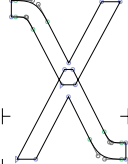
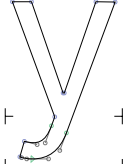

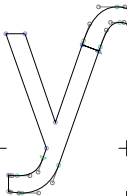
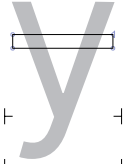











ř rcaron 0159 ř rdblgrave 0211 ř rinvertedbreve 0213 ř rdotaccent 1E59 ř rdotbelow 1E5B ř rdotbelowmacron 1E5D

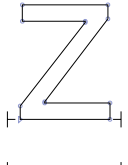

r rlinebelow 1E5F r.r 027D rrthook.1 027D uni024D.1 rdescend.1 027C racute.1

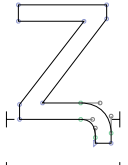
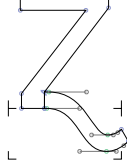
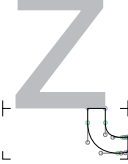
rcommaaccent.1 rcaron.1 rdblgrave.1 rinvertedbreve.1 rdotaccent.1 rdotbelow.1





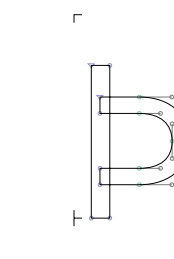
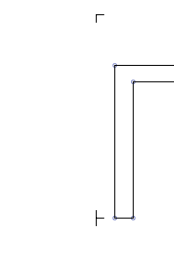
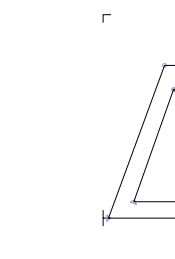

ř rdotbelowmacron.1 rlinebelow.1 s s 0073 s srthook 0282 uni023F 023F sacute 015B

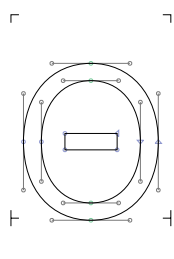
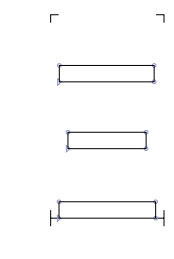
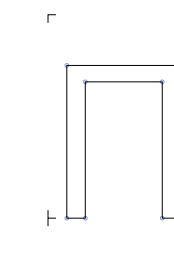
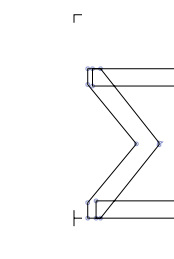
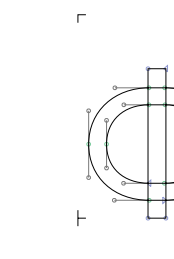
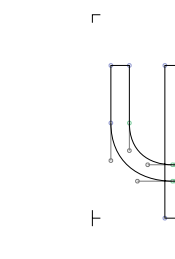

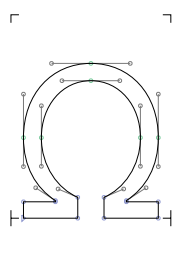



					
scircumflex 015D	scedilla 015F	scaron 0161	scommaaccent 0219	sdotaccent 1E61	sdotbelow 1E63
					
sacutedotaccent 1E65	scarondotaccent 1E67	sdotbelowdotaccent 1E69	dzeczyllic 0455	tonetwo 01A8	germandbls 00DF
					
germandbls.1	_part.t_base	t 0074	tpalatalhook 01AB	trhook 0288	tcurl 0236
					
tccurl 02A8	tturn 0287	tbar 0167	tcedilla 0163	tcaron 0165	tcommaaccent 021B
					
tdotaccent 1E6B	tdotbelow 1E6D	tlinebelow 1E6F	tcircumflexbelow 1E71	tdieresis 1E97	u 0075
					
udieresis 00FC	utilde 0169	uhorn 0180	micro 00B5	ubar 0289	ugrave 00F9
					
uacute 00FA	ucircumflex 00FB	umacron 016B	ubreve 016D	uring 016F	uhungarumlaut 0171
					
uogonek 0173	ucaron 01D4	udieresismacron 01D6	udieresisacute 01D8	udieresiscaron 01DA	udieresisgrave 01DC
					
udblgrave 0215	uinvertedbreve 0217	udieresisbelow 1E73	utildebelow 1E75	ucircumflexbelow 1E77	utildeacute 1E79







					
umacron dieresis 1E7B	udot below 1EE5	uhook above 1EE7	uhorn acute 1EE9	uhorn grave 1EEB	uhorn hook above 1EED
					
uhorn tilde 1EEF	uhorn dot below 1EF1	v 0076	v turn 028C	v tilde 1E7D	v dot below 1E7F
					
w 0077	w dieresis 1E85	w turn 028D	w circumflex 0175	w grave 1E81	w acute 1E83
					
w dot accent 1E87	w dot below 1E89	w ring 1E98	x 0078	x dot accent 1E8B	x dieresis 1E8D
					
khacyrillic 0445	chi 03C7	y 0079	y dieresis 00FF	y hook 01B4	uni024F 024F
					
y acute 00FD	y circumflex 0177	uni0233 0233	y dot accent 1E8F	y ring 1E99	y grave 1EF3
					
y dot below 1EF5	y hook above 1EF7	y tilde 1EF9	y cyrillic 0443	y short cyrillic 045E	y macron cyrillic 04EF
					
y dieresis cyrillic 04F1	y hungary macron cyrillic 04F3	y turn 028E	z 007A	z bar 01B6	z hook 0225
					
uni0240 0240	zr hook 0290	z acute 017A	z dot accent 017C	z caron 017E	z circumflex 1E91





 **zdotbelow** 1E93  **zlinebelow** 1E95  **zcurl** 0291  **Thorn** 00DE  **Gamma** 0393  **Delta** 0394



 **Theta** 0398  **Xi** 039E  **Pi** 03A0  **Sigma** 03A3  **Phi** 03A6  **Psi** 03A8

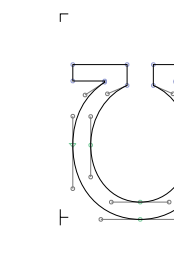
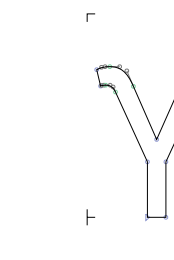

 **Omega** 03A9  **uni1FFB** 1FFB  **Omegatonos** 038F  **uni1F68** 1F68  **uni1F69** 1F69  **uni1F6A** 1F6A

 **uni1F6B** 1F6B  **uni1F6C** 1F6C  **uni1F6D** 1F6D  **uni1F6E** 1F6E  **uni1F6F** 1F6F  **uni1FFA** 1FFA

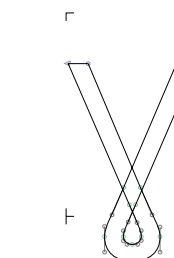
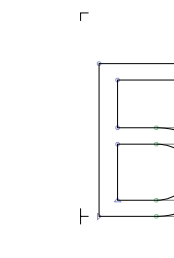
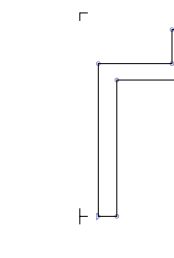
 **uni1FA8** 1FA8  **uni1FA9** 1FA9  **uni1FAA** 1FAA  **uni1FAB** 1FAB  **uni1FAC** 1FAC  **uni1FAD** 1FAD

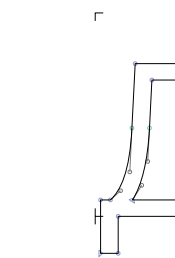
 **uni1FAE** 1FAE  **uni1FAF** 1FAF  **uni1FFC** 1FFC  **Upsilon2** 01B1  **Upsilonhooksymbol** 03D2  **Upsilonacutehooksymbol** 03D3

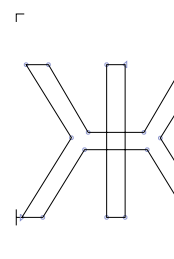
 **Upsilondieresishooksymb** 03D4  **Gamma1** 0194  **afii10018** 0411  **afii10050** 0490  **uni04FA** 04FA  **afii10021** 0414

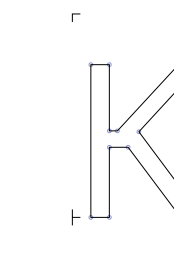
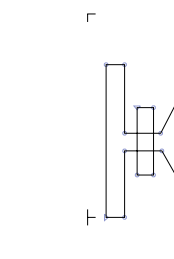
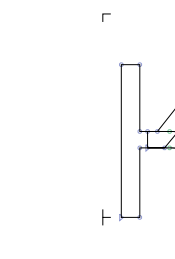
 **afii10024** 0416  **Zhedescendercyrillic** 0496  **afii10025** 0417  **Kacyr** 041A  **Kaverticastrokescyrillic** 049C  **Kahookcyrillic** 04C3

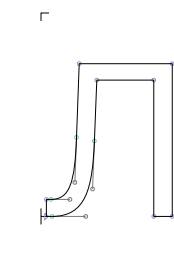
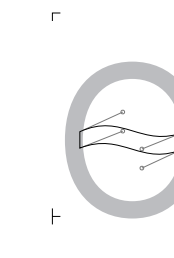
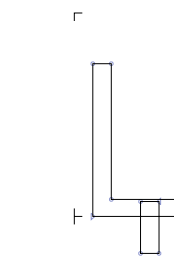
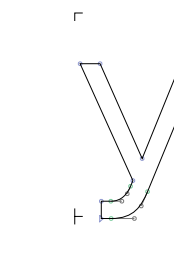
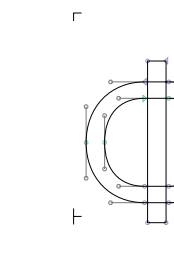
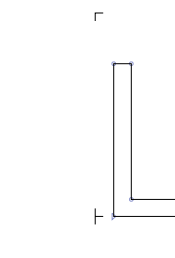
 **afii10029** 041B  **afii10147** 0472  **afii10145** 040F  **afii10037** 0423  **afii10038** 0424  **afii10040** 0426

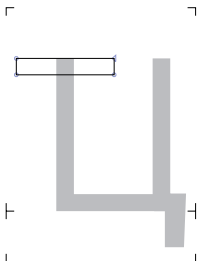

Tetsecyrillic 04B4

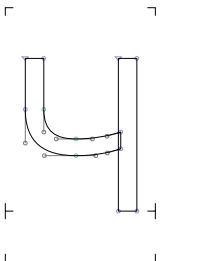

afii10041 0427



Chedescendercyrillic 04B6

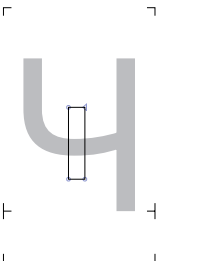

Cheverticalstrokecyrillic 04B8



Shhacyrillic 04BA

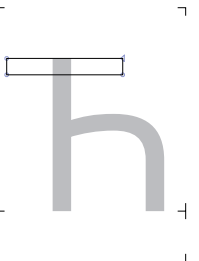

afii10060 040B

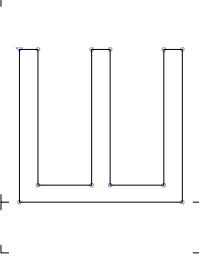

afii10042 0428

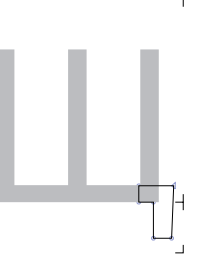

afii10043 0429

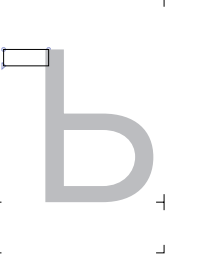

afii10044 042A



afii10045 042B

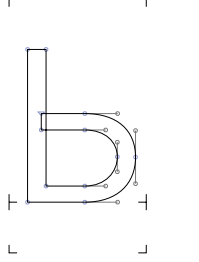

afii10046 042C

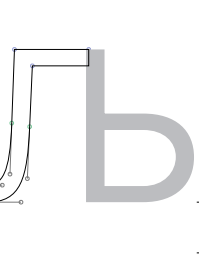

afii10058 0409

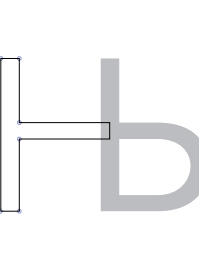

afii10059 040A

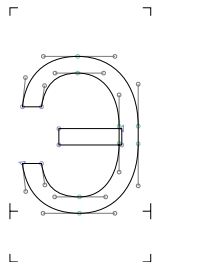

afii10047 042D



afii10048 042E



afii10049 042F



Ghemiddlehookcyrillic 0494



Pemiddlehookcyrillic 04A6

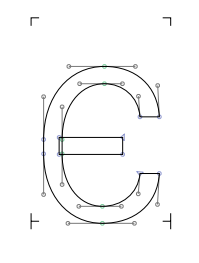

afii10053 0404

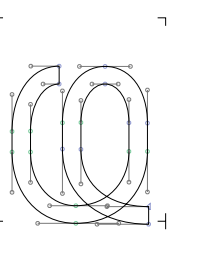

Haabkhasiancyrillic 04A8

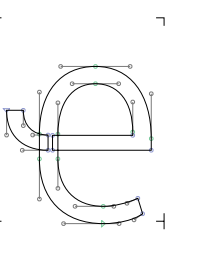

Cheabkhasiancyrillic 04BC

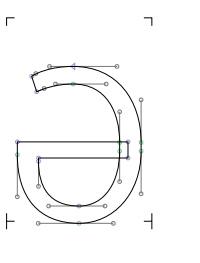

Schwacyrillic 04D8



Dzeabkhasiancyrillic 04E0

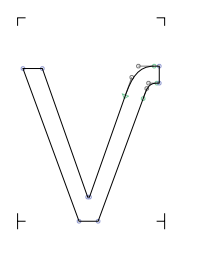

afii10148 0474

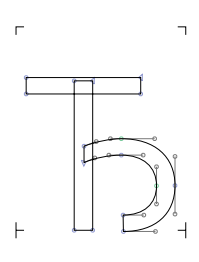

afii10051 0402

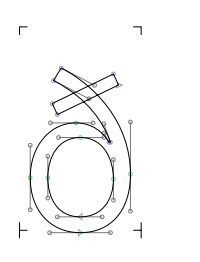

eth 00F0

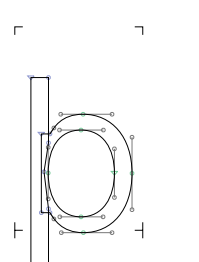

thorn 00FE

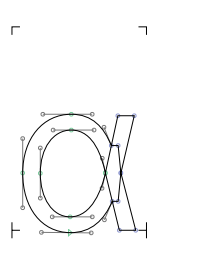

alpha 03B1

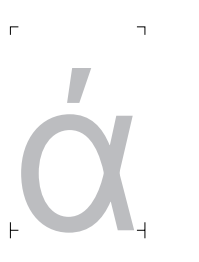

alphatonos 03AC

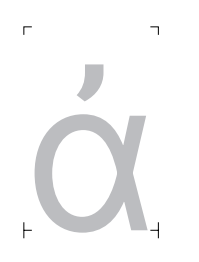

uni1F00 1F00

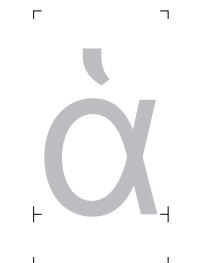

uni1F01 1F01

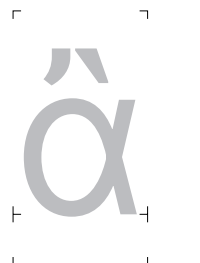

uni1F02 1F02



uni1F03 1F03



uni1F04 1F04

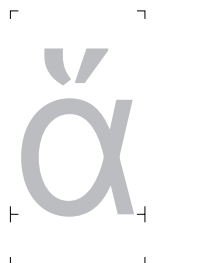

uni1F05 1F05

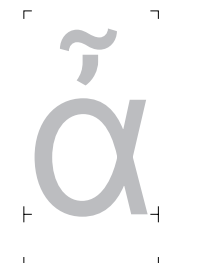

uni1F06 1F06

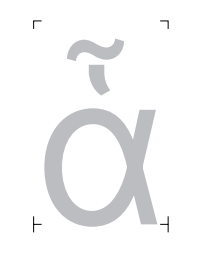

uni1F07 1F07

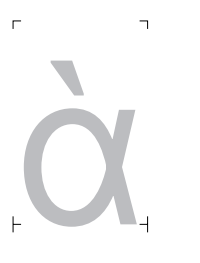

uni1F70 1F70

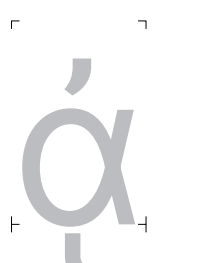

uni1F80 1F80

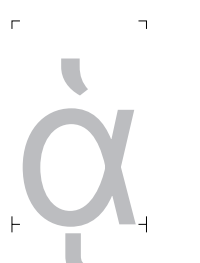

uni1F81 1F81

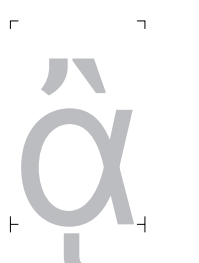

uni1F82 1F82

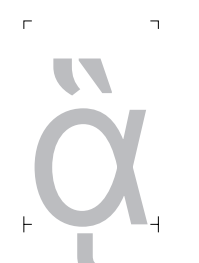

uni1F83 1F83



uni1F84 1F84



uni1F85 1F85



uni1F86 1F86

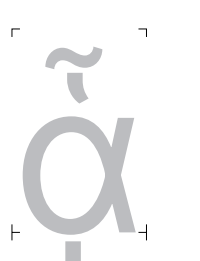

uni1F87 1F87



uni1FB0 1FB0

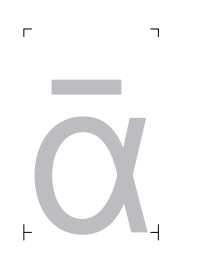

uni1FB1 1FB1

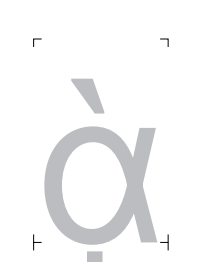

uni1FB2 1FB2



uni1FB3 1FB3



uni1FB4 1FB4



uni1FB6 1FB6



uni1FB7 1FB7

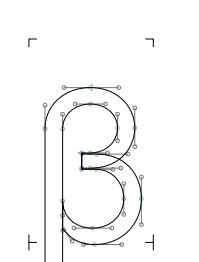

beta 03B2

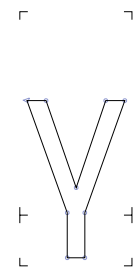

gamma 03B3

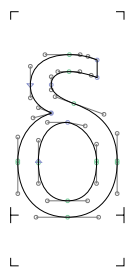

delta 03B4

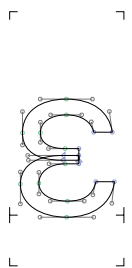

epsilon 03B5



epsilon_tonos 03AD

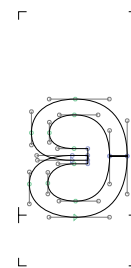

epsilon_closed 029A



epsilon_1 025B



epsilon_1_rev 025C



epsilon_1_rev_closed 025E

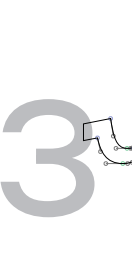

epsilon_1_rev_hook 025D



uni1F10 1F10



uni1F11 1F11



uni1F12 1F12



uni1F13 1F13



uni1F14 1F14



uni1F15 1F15



uni1F72 1F72

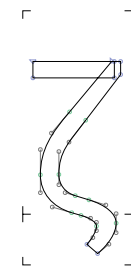

zeta 03B6

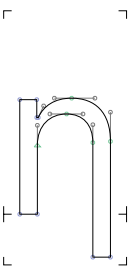

eta 03B7



eta_tonos 03AE



uni1F20 1F20



uni1F21 1F21



uni1F22 1F22



uni1F23 1F23



uni1F24 1F24



uni1F25 1F25



uni1F26 1F26



uni1F27 1F27



uni1F74 1F74



uni1F90 1F90



uni1F91 1F91



uni1F92 1F92



uni1F93 1F93



uni1F94 1F94



uni1F95 1F95



uni1F96 1F96



uni1F97 1F97



uni1FC2 1FC2



uni1FC3 1FC3



uni1FC4 1FC4



uni1FC6 1FC6



uni1FC7 1FC7

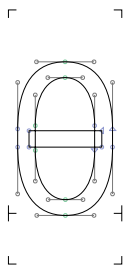

theta 03B8



iota 03B9



iota_dieresis_tonos 0390



iota_tonos 03AF



iota_dieresis 03CA



uni1F30 1F30



uni1F31 1F31



uni1F32 1F32



uni1F33 1F33



uni1F34 1F34



uni1F35 1F35



uni1F36 1F36



uni1F37 1F37



uni1F76 1F76



uni1FD0 1FD0



uni1FD1 1FD1



uni1FD2 1FD2



uni1FD6 1FD6



uni1FD7 1FD7



lambda 03BB

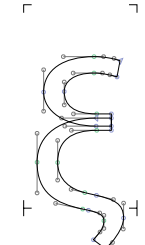

xi 03BE

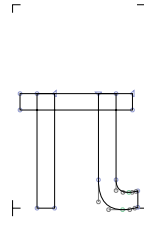

pi 03C0

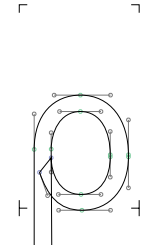

rho 03C1



uni1FE4 1FE4



uni1FE5 1FE5



uni03FC 03FC

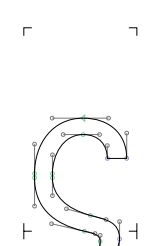

sigma1 03C2

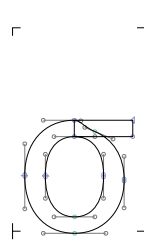

sigma 03C3

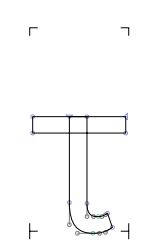

tau 03C4

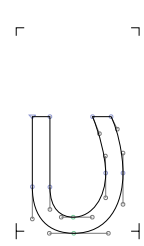

upsilon 03C5



upsilondieresistonos 03B0



upsilondieresis 03CB



upsilontonos 03CD



uni1F50 1F50



uni1F51 1F51



uni1F52 1F52



uni1F53 1F53



uni1F54 1F54



uni1F55 1F55



uni1F56 1F56



uni1F57 1F57



uni1F7A 1F7A



uni1FE0 1FE0



uni1FE1 1FE1



uni1FE2 1FE2



uni1FE6 1FE6



uni1FE7 1FE7

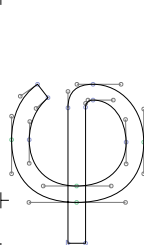

phi 03C6

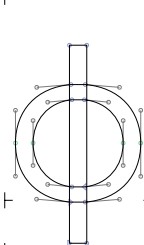

phigreek 03D5

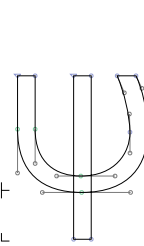

psi 03C8

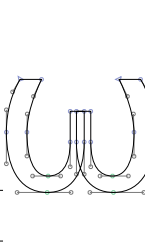

omega 03C9



omegatonos 03CE



uni1F60 1F60



uni1F61 1F61



uni1F62 1F62



uni1F63 1F63



uni1F64 1F64



uni1F65 1F65



uni1F66 1F66



uni1F67 1F67



uni1F7C 1F7C



uni1FA0 1FA0



uni1FA1 1FA1



uni1FA2 1FA2



uni1FA3 1FA3



uni1FA4 1FA4



uni1FA5 1FA5

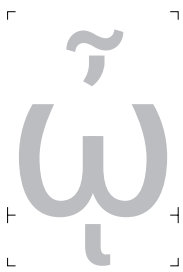

uni1FA6 1FA6

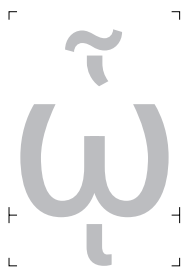

uni1FA7 1FA7



uni1FF2 1FF2



uni1FF3 1FF3



uni1FF4 1FF4



uni1FF6 1FF6

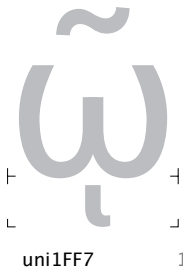

uni1FF7 1FF7

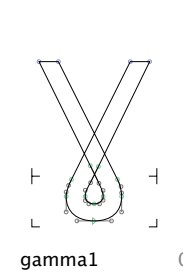

gamma1 0263

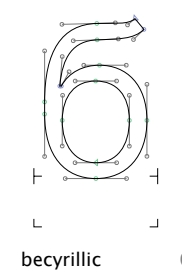

becyrillic 0431

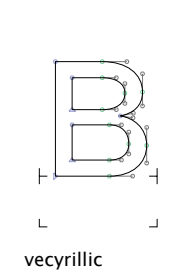

vecyrillic 0432

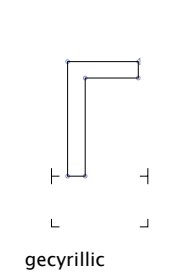

gecyrillic 0433

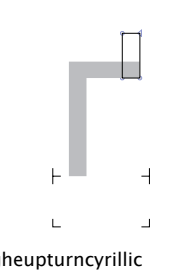

gheupturncyrillic 0491



uni04FB 04FB

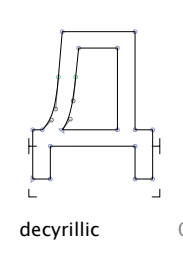

decyrillic 0434

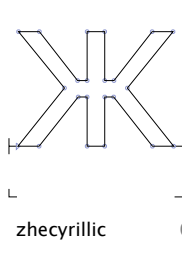

zhecyrillic 0436



zhedescendercyrillic 0497

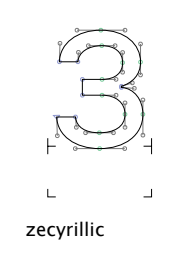

zecyrillic 0437

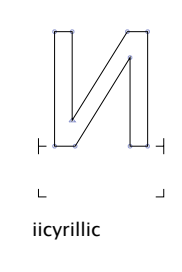

iicyrillic 0438



uni048B 048B

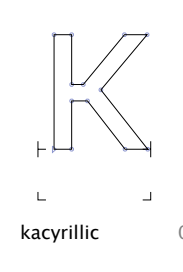

kacyrillic 043A

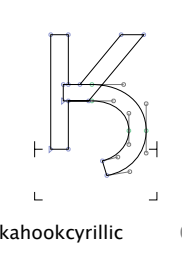

kahookcyrillic 04C4

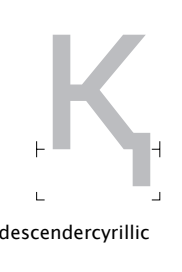

kadescendercyrillic 049B

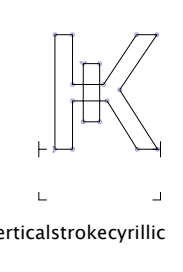

kaverticastrokescyrillic 049D

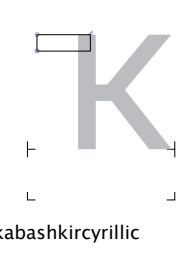

kabashkircyrillic 04A1

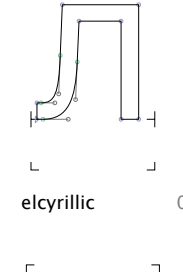

elcyrillic 043B

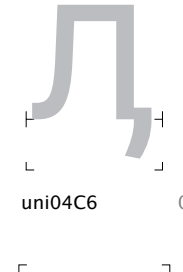

uni04C6 04C6

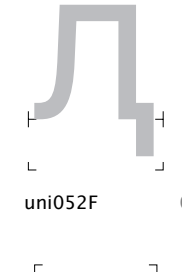

uni052F 052F

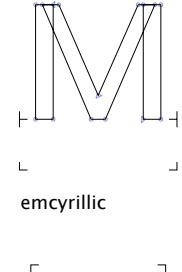

emcyrillic 043C

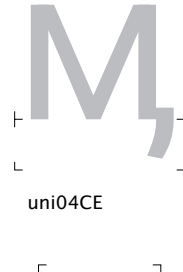

uni04CE 04CE

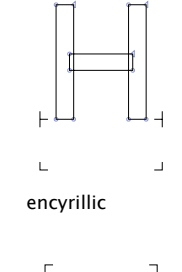

encyrillic 043D

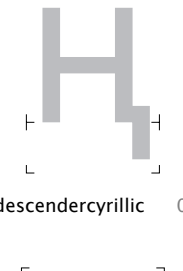

endescendercyrillic 04A3



enghecyrillic 04A5

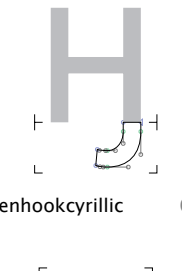

enhookcyrillic 04C8

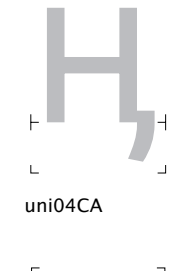

uni04CA 04CA

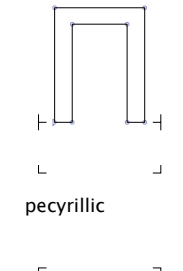

pecyrillic 043F

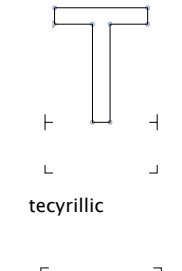

tecyrillic 0442

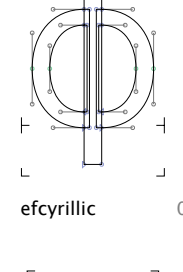

efcyrillic 0444

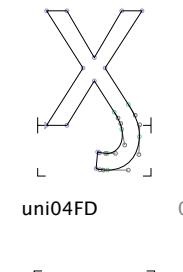

uni04FD 04FD

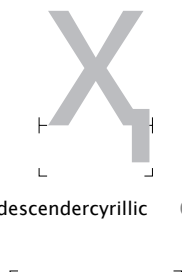

hadescendercyrillic 04B3

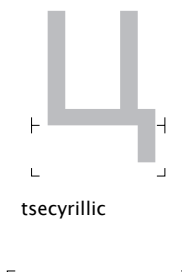

tsecyrillic 0446

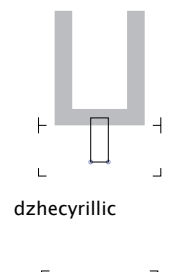

dzhecyrillic 045F

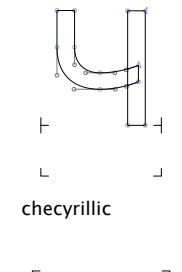

checyrillic 0447



chedescendercyrillic 04B7

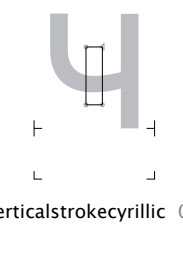

cheverticalstrokescyrillic 04B9

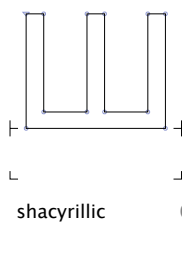

shacyrillic 0448

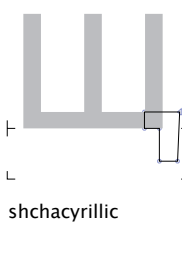

shchacyrillic 0449

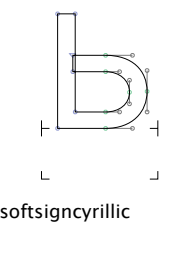

softsigncyrillic 044C



hardsigncyrillic 044A



yericyrillic 044B

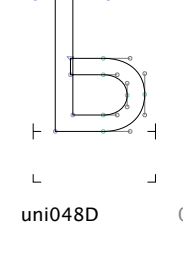

uni048D 048D

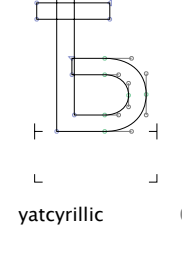

yatcyrillic 0463

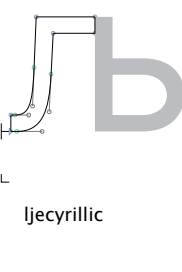

ljecyrillic 0459

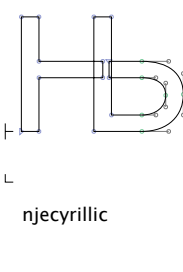

njecyrillic 045A

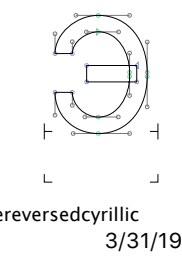

ereversedcyrillic 044D

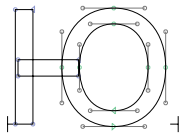

iucyrillic 044E

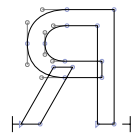

iacyrillic 044F

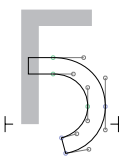

ghemiddlehookcyrillic 0495

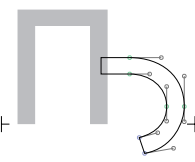

pemiddlehookcyrillic 04A7

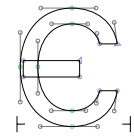

ecyrillic 0454

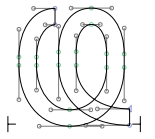

haabkhasiancyrillic 04A9

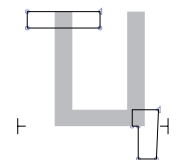

tetsecyrillic 04B5

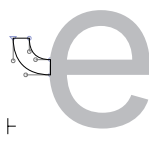

cheabkhasiancyrillic 04BD



dzeabkhasiancyrillic 04E1

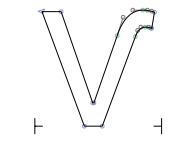

izhitsacyrillic 0475



dollar 0024

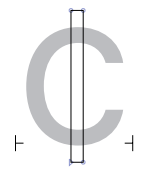

cent 00A2

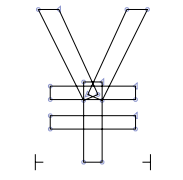

yen 00A5

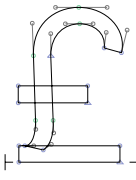

sterling 00A3

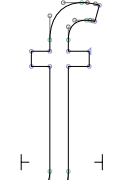

florin 0192

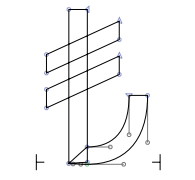

uni20BA 20BA

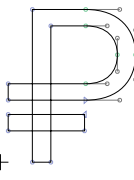

uni20BD 20BD

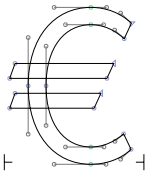

euro 20AC

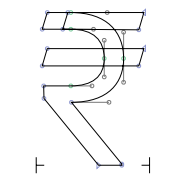

uni20B9 20B9

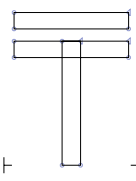

tenge 20B8

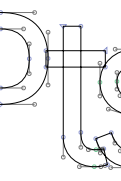

peseta 20A7

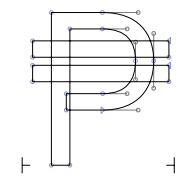

peso 20B1

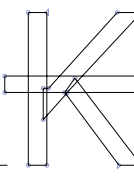

kip 20AD

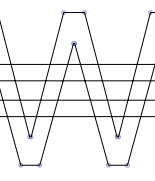

won 20A9

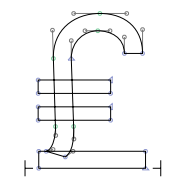

lira 20A4

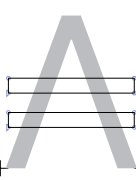

austral 20B3

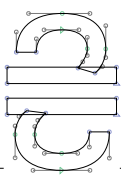

hryvnia 20B4

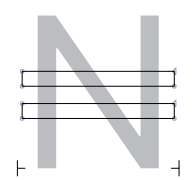

naira 20A6



guarani 20B2

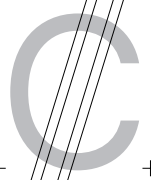

coloncurrency 20A1

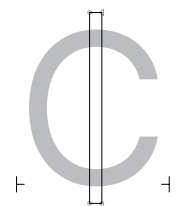

cedi 20B5

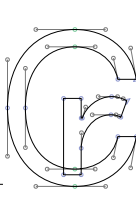

cruzeiro 20A2

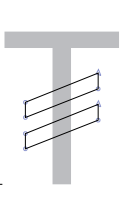

tugrik 20AE

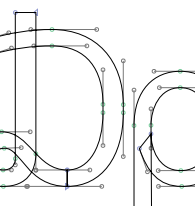

uni20AF 20AF

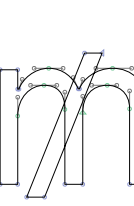

mill 20A5

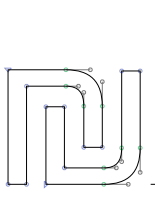

afi57636 20AA

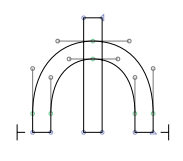

manat 20BC



rupee 20A8

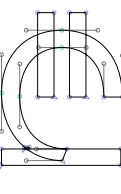

lari 20BE



franc 20A3

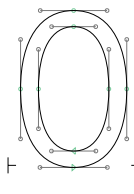

zero 0030

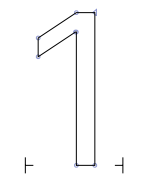

one 0031

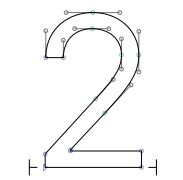

two 0032



twostroke 01BB

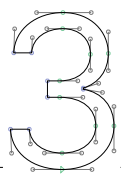

three 0033

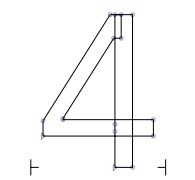

four 0034

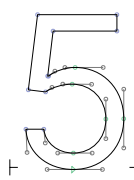

five 0035

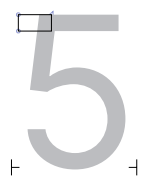

Tonefive 01BC

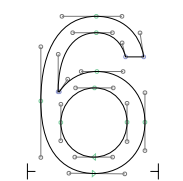

six 0036

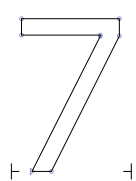

seven 0037

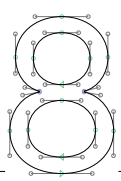

eight 0038

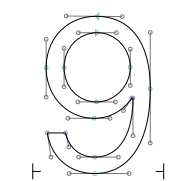

nine 0039

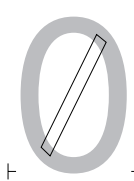

zero.slash

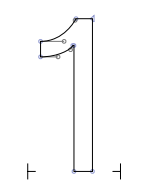

one.ss01

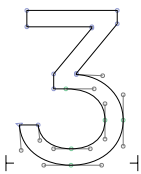

three.1

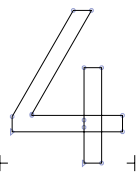

four.ss01

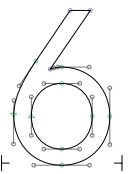

six.ss01

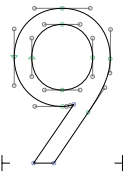

nine.ss01



zero.tf



one.tf



two.tf



three.tf



four.tf



five.tf



six.tf



seven.tf



eight.tf



nine.tf



zero.tf.slash



one.tf.ss01



three.1.tf



four.tf.ss01



six.tf.ss01



nine.tf.ss01

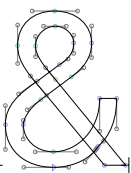

ampersand 0026

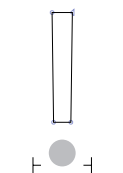

exclam 0021



exclamdbl 203C



exclamdown 00A1



uni2049 2049

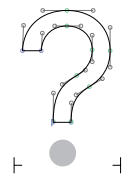

question 003F



uni2047 2047



uni2048 2048



questiondown 00BF

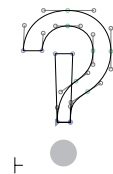

interrobang 203D



invertedinterrobang 2E18

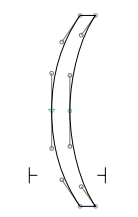

parenleft 0028



parenright 0029

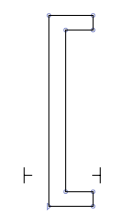

bracketleft 005B

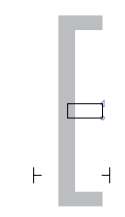

bracketleft_quill 2045



bracketright 005D

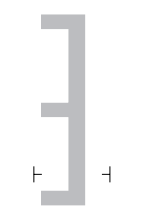

bracketright_quill 2046

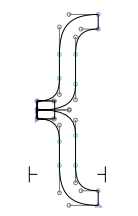

braceleft 007B



braceright 007D

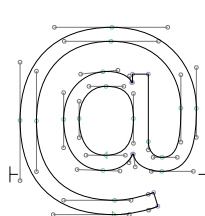

at 0040



parenleft.case



parenright.case



bracketleft.case



bracketright.case



braceleft.case



braceright.case



at.case

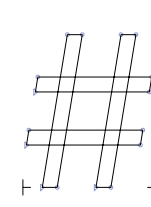

numbersign 0023

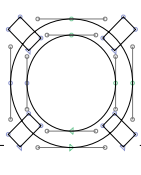

currency 00A4

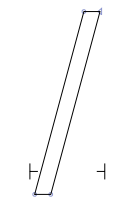

slash 002F

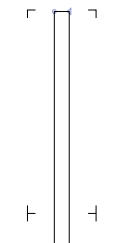

bar 007C

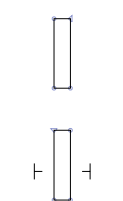



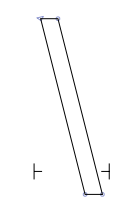



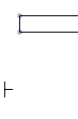



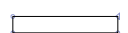
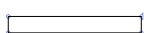
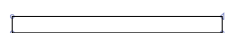

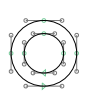

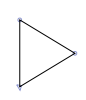
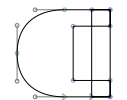
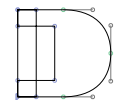































brokenbar 00A6



backslash 005C

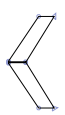

hyphen 002D

					
softhyphen 00AD	endash 2013	figuredash 2012	emdash 2014	horizontalbar 2015	bullet 2022
					
openbullet 25E6	hyphenbullet 2043	trianglebullet 2023	blackleftbullet 204C	blackrightbullet 204D	hyphen.case
					
endash.case	figuredash.case	emdash.case	bullet.case	openbullet.case	hyphenbullet.case
					
trianglebullet.case	blackleftbullet.case	blackrightbullet.case	quoteleft 2018	quoteright 2019	apostrophemod 02BC
					
quotesingle 0027	quotedbl 0022	quotedblleft 201C	quotedblright 201D	quotedblbase 201E	quotesinglbase 201A
					
prime 2032	doubleprime 2033	tripleprime 2034	quadrupleprime 2057	primerev 2035	doubleprimerev 2036
					
tripleprimerev 2037	primemod 02B9	doubleprimemod 02BA	comma 002C	period 002E	ellipsis 2026
					
twodotleader 2025	colon 003A	colon.case	semicolon 003B	comma.tf	period.tf
					
colon.tf	semicolon.tf	periodcentered 00B7	anoteleia 0387	questiongreek 037E	guilsingleft 2039

					
guilsingright 203A	guillemetleft 00AB	guillemetright 00BB	less 003C	greater 003E	lessequal 2264
					
greaterequal 2265	equal 003D	notequal 2260	plus 002B	minus 2212	multiply 00D7
					
divide 00F7	plusminus 00B1	aproxequal 2248	asciitilde 007E	less.case	greater.case
					
lessequal.case	greaterequal.case	equal.case	notequal.case	plus.case	minus.case
					
multiply.case	divide.case	plusminus.case	aproxequal.case	asciitilde.case	logicalnot 00AC
					
underscore 005F	dagger 2020	daggerdbl 2021	asciicircum 005E	asterisk 002A	asterisk.case
					
registered 00AE	trademark 2122	servicemark 2120	tel 2121	uni213B 213B	uni1F16B 1F16B
					
uni1F16A 1F16A	degree 00B0	ordfeminine 00AA	ordmasculine 00BA	i.numr	n.numr
					
paragraph 00B6	paragraphreversed 204B	section 00A7	copyright 00A9	infinity 221E	partialdiff 2202

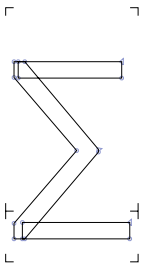

summation 2211

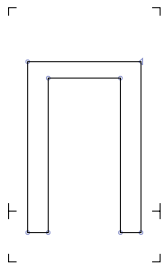

product 220F

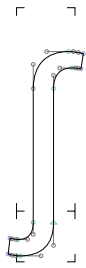

integral 222B

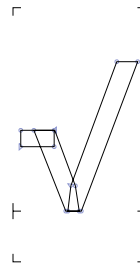

radical 221A

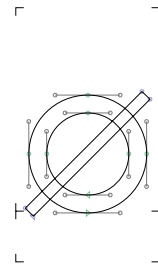

emptyset 2205

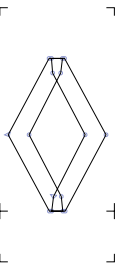

lozenge 25CA

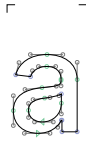

a.sups 1D43

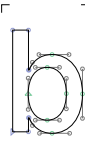

b.sups 1D47

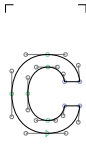

c.sups 1D9C

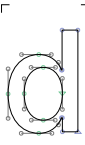

d.sups 1D48

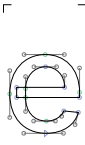

e.sups 1D49

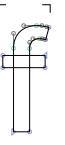

f.sups 1DA0

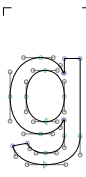

g.sups 1D4D

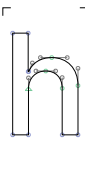

h.sups 02B0

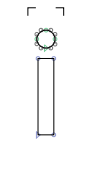

i.sups 2071

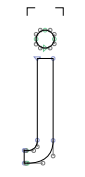

j.sups 02B2

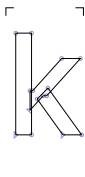

k.sups 1D4F



l.sups 02E1

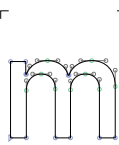

m.sups 1D50

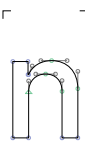

n.sups 207F

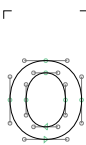

o.sups 1D52

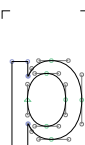

p.sups 1D56

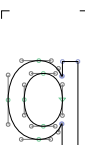

q.sups 146B

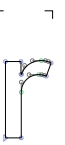

r.sups 02B3

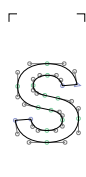

s.sups 02E2

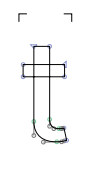

t.sups 1D57

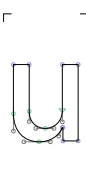

u.sups 1D58

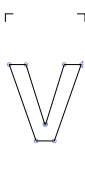

v.sups 1D5B



w.sups 02B7



x.sups 02E3

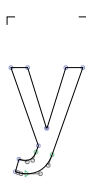

y.sups 02B8

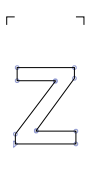

z.sups 1DBB

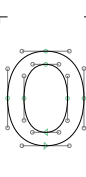

zero.sups 2070

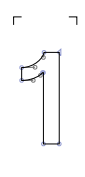

one.sups 00B9

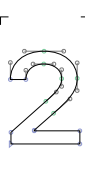

two.sups 00B2

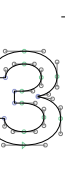

three.sups 00B3

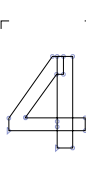

four.sups 2074

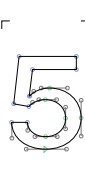

five.sups 2075

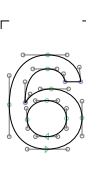

six.sups 2076

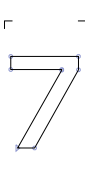

seven.sups 2077

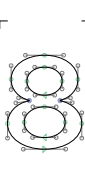

eight.sups 2078



nine.sups 2079



parenleft.sups 207D

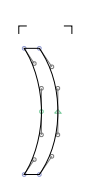

parenright.sups 207E

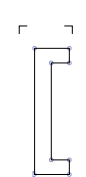

bracketleft.sups

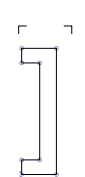

bracketright.sups

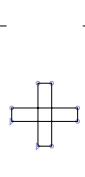

plus.sups 207A



minus.sups 207B

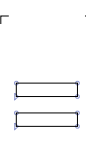

equal.sups 207C



a.subs 2090



b.subs



c.subs



d.subs



e.subs 2091

f

f.subs

g

g.subs

h

h.subs 2095

i

i.subs 1D62

j

j.subs 2C7C

k

k.subs 2096

l

l.subs 2097

m

m.subs 2098

n

n.subs 2099

o

o.subs 2092

p

p.subs 209A

q

q.subs

r

r.subs 1D63

s

s.subs 209B

t

t.subs 209C

u

u.subs 1D64

v

v.subs 1D65

w

w.subs

x

x.subs 2093

y

y.subs

z

z.subs

0

zero.subs 2080

1

one.subs 2081

2

two.subs 2082

3

three.subs 2083

4

four.subs 2084

5

five.subs 2085

6

six.subs 2086

7

seven.subs 2087

8

eight.subs 2088

9

nine.subs 2089

(

parenleft.subs 208D

)

parenright.subs 208E

[

bracketleft.subs

]

bracketright.subs

+

plus.subs 208A

-

minus.subs 208B

=

equal.subs 208C

0

zero.dnomf

1

one.dnomf

2

two.dnomf

3

three.dnomf

4

four.dnomf

5

five.dnomf

6

six.dnomf

7

seven.dnomf

8

eight.dnomf

9

nine.dnomf

/

fraction 2044

0

zero.dnom

1

one.dnom

2

two.dnom

3

three.dnom

4

four.dnom

5

five.dnom

6

six.dnom

7

seven.dnom

8

eight.dnom

9

nine.dnom

+

plus.dnom

-

minus.dnom

=

equal.dnom

(

parenleft.dnom

)

parenright.dnom

0

zero.numr

1

one.numr

2

two.numr

3

three.numr

4

four.numr

5

five.numr

6

six.numr

7

seven.numr

8

eight.numr

9

nine.numr

+

plus.numr

-

minus.numr

=

equal.numr

(

parenleft.numr

)

parenright.numr

0

zero.frac

1

one.frac

2

two.frac

3

three.frac

4

four.frac

5

five.frac

6

six.frac

7

seven.frac

8

eight.frac

9

nine.frac

1/2

onehalf 00BD

1/3

onethird 2153

1/4

onequarter 00BC

3/4

threequarters 00BE

5/6

fivesixths 215A

1/

onefraction 215F

7/8

seveneighths 215E

1/8

oneeighth 215B

5/8

fiveeighths 215D

3/8

threeeighths 215C

%

percent 0025

‰

perthousand 2030

‱

pertenthousand 2031

ℳ/s

uni214D 214D

℄/u

cadauna 2106

℅/o

careof 2105

℆/c

accountof 2100

ℇ/s

addresssubject 2101

№

numero 2116

acute 00B4	hungarumlaut 02DD	grave 0060	tonos 0384	dieresis 00A8	casedieresis.cn
circumflex 02C6	tilde 02DC	casetilde.cn	macron 00AF	breve 02D8	cyrillicbreve
dotaccent 02D9	ring 02DA	ring.uc	caron 02C7	dieresis-tonos 0385	cedilla 00B8
ogonek 02DB	commaaccent F6C3	acutecomb 0301	acutedblnosp 030B	gravecomb 0300	dblgravecmb 030F
macroncomb 0304	dieresisnosp 0308	brevenosp 0306	breveinvnosp 0311	hook 0309	circumflexnosp 0302
caroncmb 030C	tildecomb 0303	dotnosp 0307	ringnosp 030A	hornnosp 031B	ogoneknosp 0328
cedillanosp 0327	circumflexsubnosp 032D	brevesubnosp 032E	dotbelow 0323	commabelowcmb 0326	dotdblsubnosp 0324
ringsubnosp 0325	underscorenosp 0332	tildesubnosp 0330	enquad 2000	emquad 2001	enspace 2002
emspace 2003	thirdemspace 2004	quarteremspace 2005	sixthemspace 2006	figurespace 2007	punctuationspace 2008

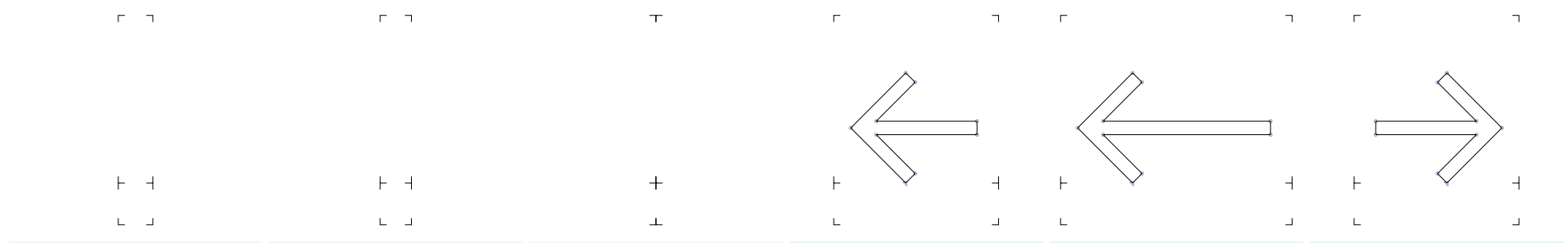

thinspace 2009 hairspace 200A zerowidthspace 200B leftArrow 2190 leftLongArrow 27F5 rightArrow 2192

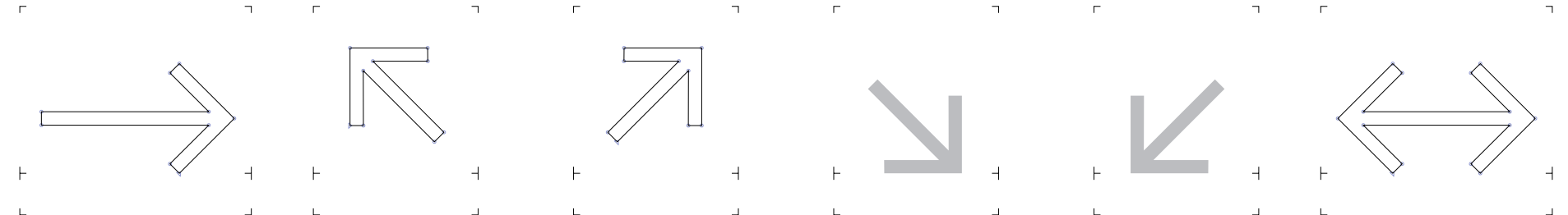

rightLongArrow 27F6 northWestArrow 2196 northEastArrow 2197 southEastArrow 2198 southWestArrow 2199 leftRightArrow 2194

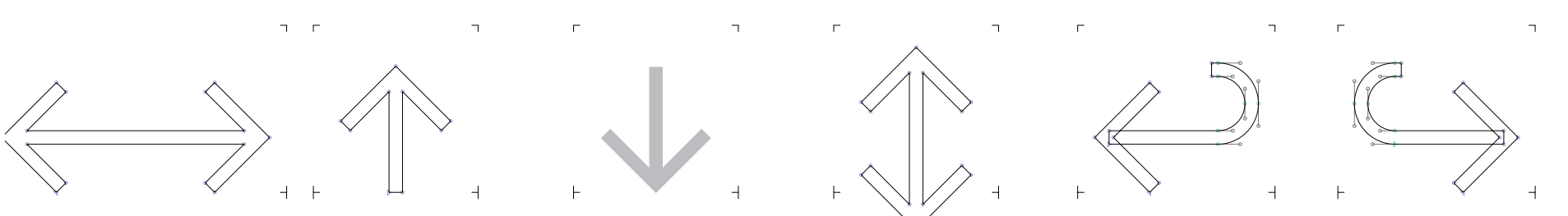

leftRightLongArrow 27F7 upArrow 2191 downArrow 2193 upDownArrow 2195 leftHookArrow 21A9 rightHookArrow 21AA

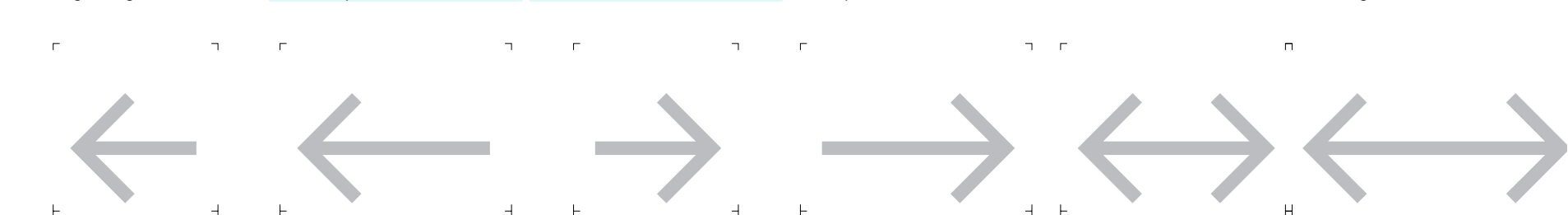

leftArrow.case leftLongArrow.case rightArrow.case rightLongArrow.case leftRightArrow.case leftRightLongArrow.case

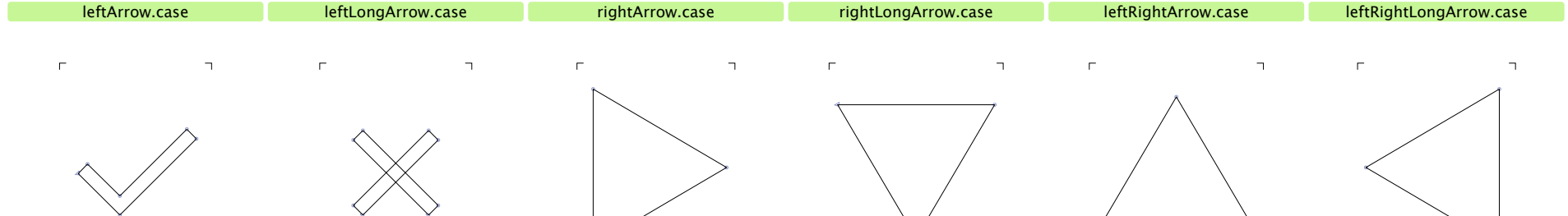

dngb_check 2713 dngb_ballotx 2717 triagrt 25BA triagdn 25BC triagup 25B2 blackleftpointingtriangle 25C0

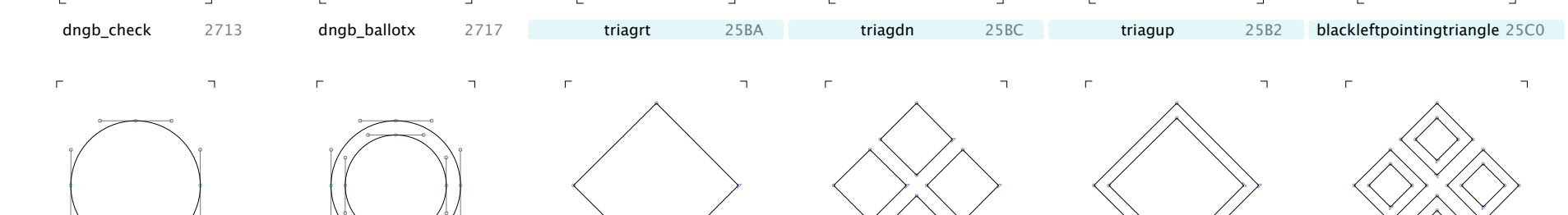

circleblack 25CF circlewhite 25CB diamondblack 25C6 diamondblack_x 2756 diamondwhite 25C7 diamondwhite_x E000

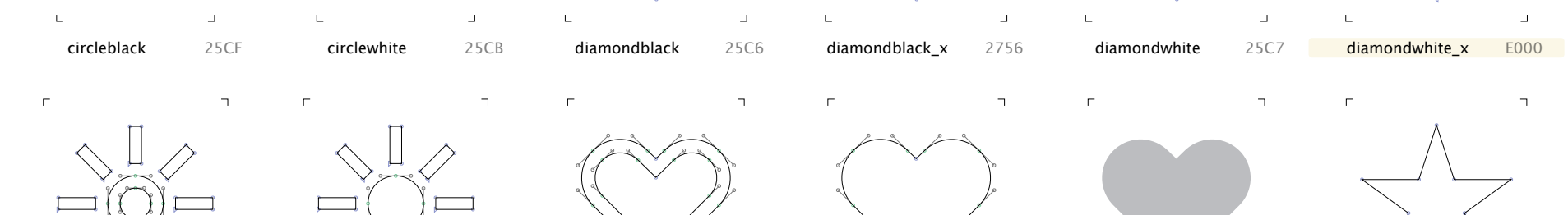

sunWithRays 263C blackSunWithRays 2600 heartWhiteSuit 2661 heartBlackSuit 2665 heavyBlackHeart 2764 blackstar 2605

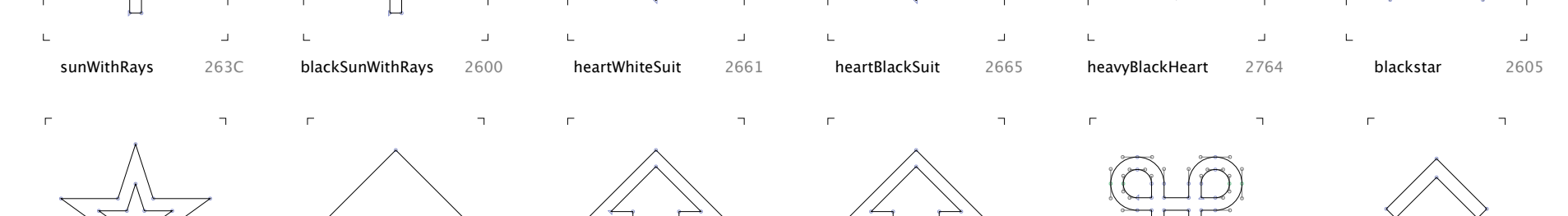



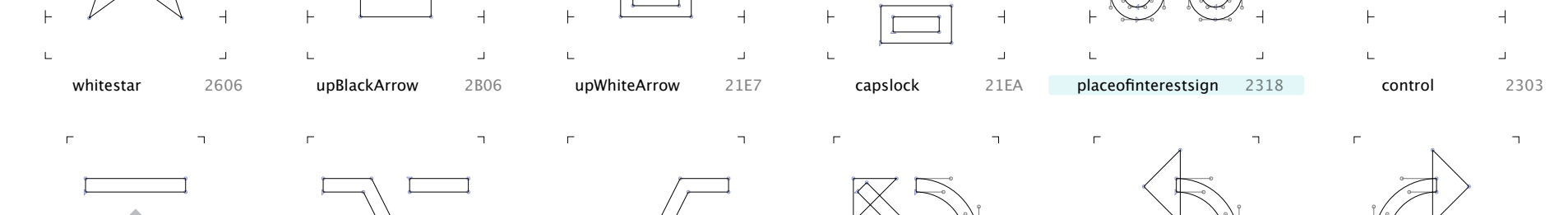



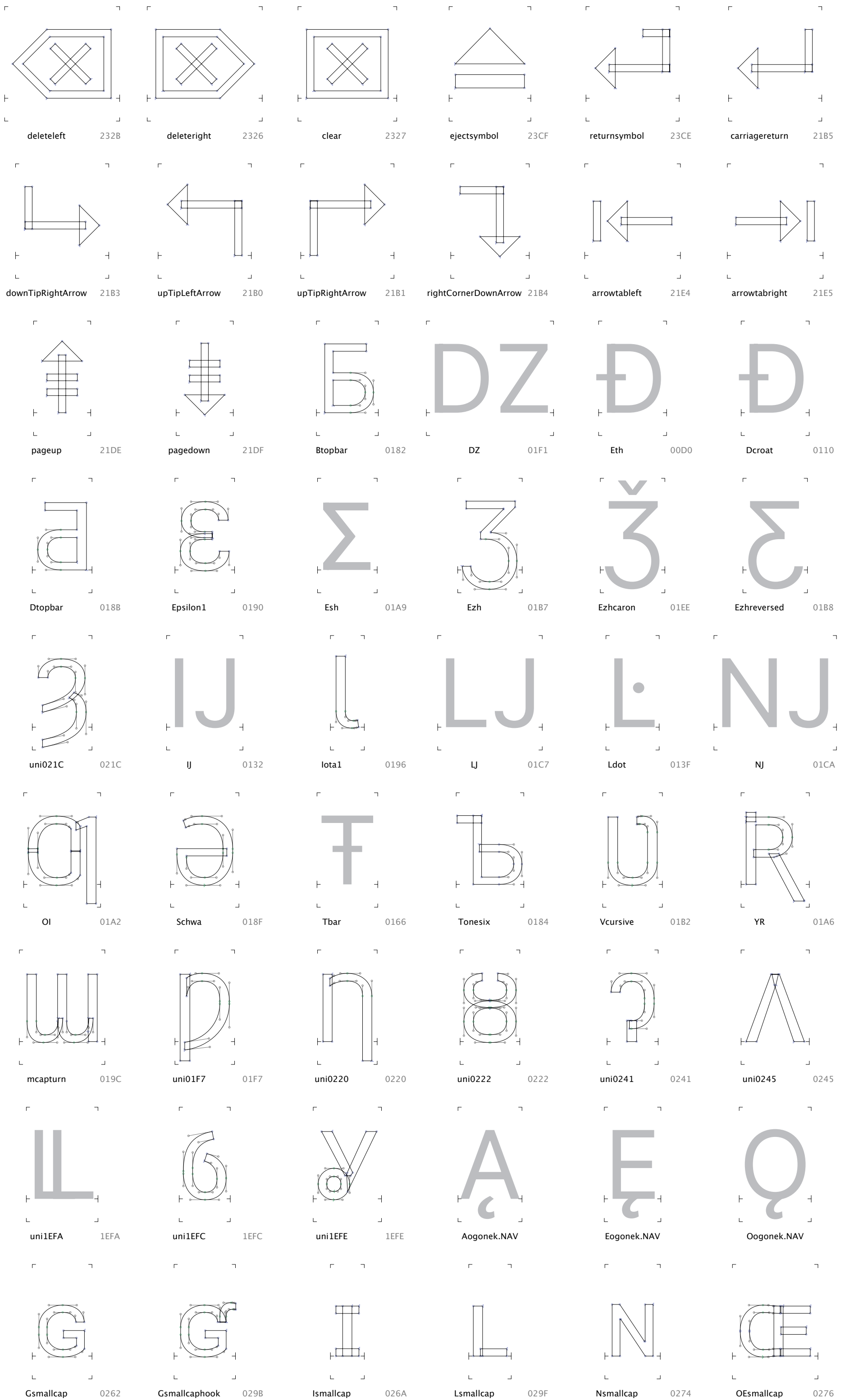

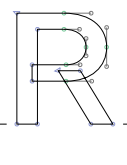
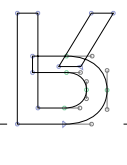
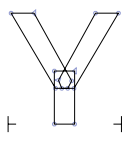

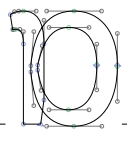
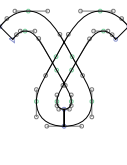
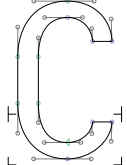
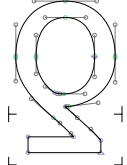
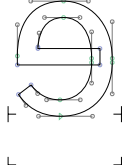
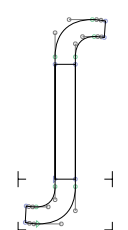
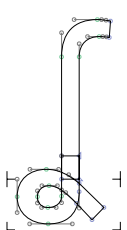
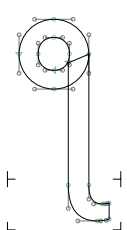
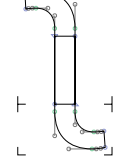

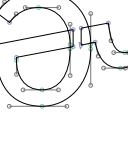

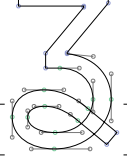
whitestar 2606 upBlackArrow 2B06 upWhiteArrow 21E7 capslock 21EA placeofinterestsign 2318 control 2303

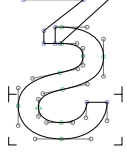

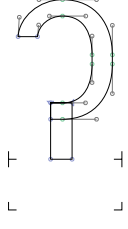
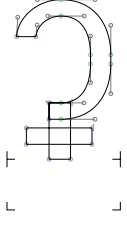
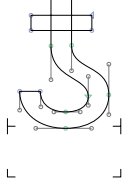
projective 2305 option 2325 alternativekeysymbol 2387 brokenCircleNorthWestAr 238B anticlockwiseOpenCircleA 21BA clockwiseOpenCircleArro 21BB

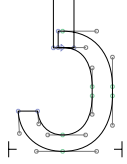
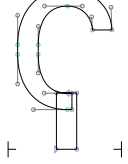
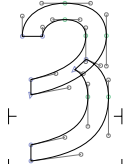
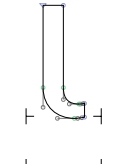
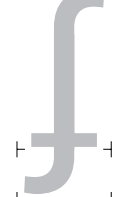
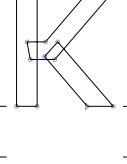
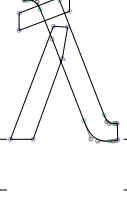
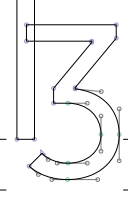
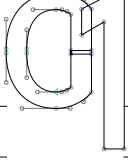
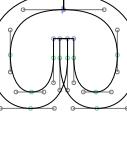
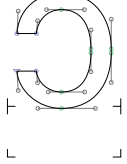
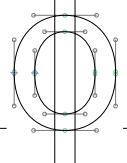
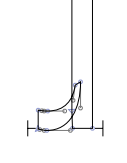
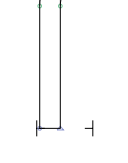
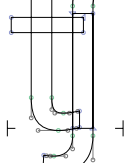
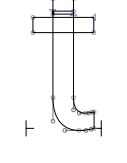
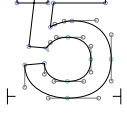
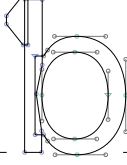
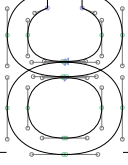
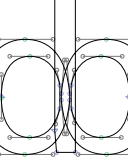
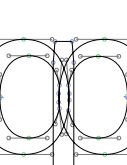
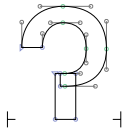

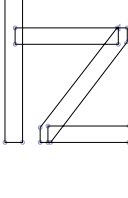
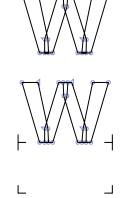
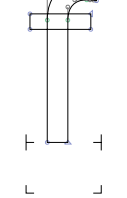
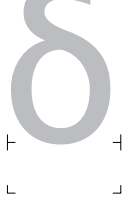
					
Rsmallcap 0280	Rsmallcapinv 0281	Ysmallcap 028F	ascript 0251	ascriptturn 0252	babygamma 0264
					
cstretch 0297	deltaturn 018D	erev 0258	esh 0283	eshcurl 0286	eshlooprev 01AA
					
eshshortrev 0285	schwa 0259	schwahook 025A	ezh 0292	ezhcaron 01EF	ezhcurl 0293
					
ezhreversed 01B9	ezhtail 01BA	gcursive 0261	glottalstop 0294	glottalstopbar 02A1	glottalstopbarinv 01BE
					
glottalstopbarrev 02A2	glottalstopinv 0296	glottalstopprevinv 0295	uni021D 021D	iota1 0269	jhookdblbar 0284
					
kgreenlandic 0138	lambdabar 019B	lyogh 026E	oi 01A3	omegaclosed 0277	oopen 0254
					
philatin 0278	rturnascend 027A	longs 017F	tesh 02A7	thook 01AD	tonefive 01BD
					
tonesix 0185	ts 02A6	uni0223 0223	uni0238 0238	uni0239 0239	uni0242 0242
					
uni0299 0299	uni029C 029C	uni02AB 02AB	uni02AC 02AC	uni1E9D 1E9D	uni1E9F 1E9F

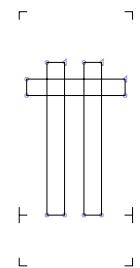

uni1EFB 1EFB

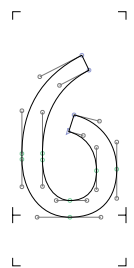

uni1EFD 1EFD

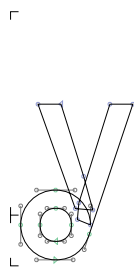

uni1EFF 1EFF

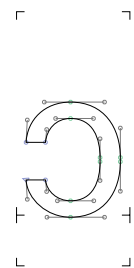

uni2184 2184

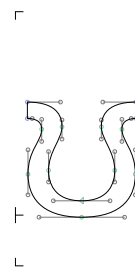

upsilonlatin 028A

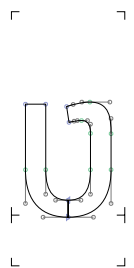

vscrip 028B

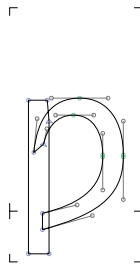

wynn 01BF



aogonek.NAV



eogonek.NAV



oogonek.NAV



uni0268.ccmp

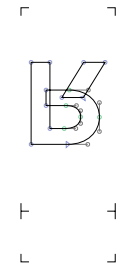

Rturnsuper 02B6



exclam1 01C3

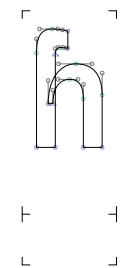

hhooksuper 02B1

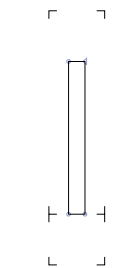

pipe 01C0



pipedbl 01C1



pipedblbar 01C2

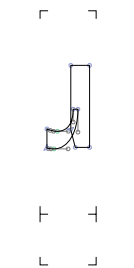

rturnsuper 02B4

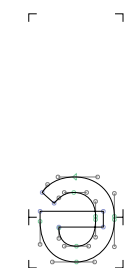

uni2094 2094

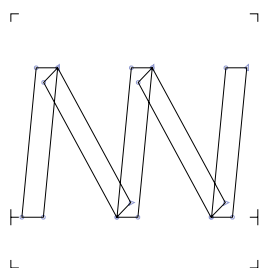

uniA7FF A7FF

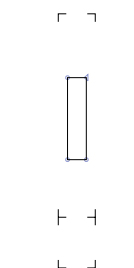

uni2071.ccmp

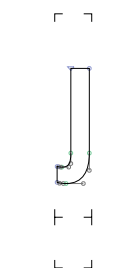

uni02B2.ccmp

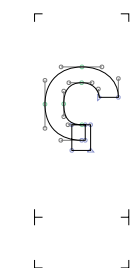

glottalstopreversed.numr 02E4



afii10020 0413



afii10052 0403



afii10061 040C



afii10033 041F



afii10034 0420



afii10035 0421



afii10036 0422



afii10062 040E



afii10039 0425

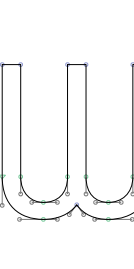

Omegacyrillic 0460



afii10146 0462

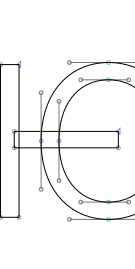

Eiotifiedcyrillic 0464

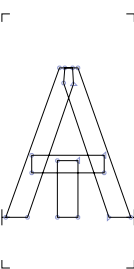

Yuslitlecyrillic 0466

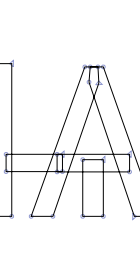

Yuslitleiotifiedcyrillic 0468

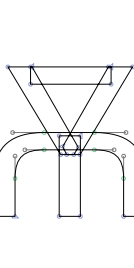

Yusbigcyrillic 046A

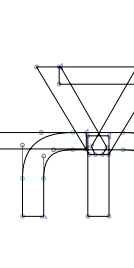

Yusbigiotifiedcyrillic 046C

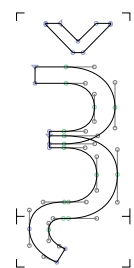

Kscyrillic 046E



Psicyrillic 0470



Izhitsadblgravecyrillic 0476



Ukcyrillic 0478



Ghestrokecyrillic 0492



Zedescendercyrillic 0498



Esdescendercyrillic 04AA



Tedescendercyrillic 04AC



Ustraightcyrillic 04AE



Ustraightstrokecyrillic 04B0
Inter



Chedescenderabkhasianc 04BE

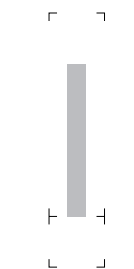

palochkacyrillic 04C0



Zhebrevecyrillic 04C1



Eltail-cy 04C5



Chekhakassiancyrillic 04CB



Schwadierescyrillic 04DA

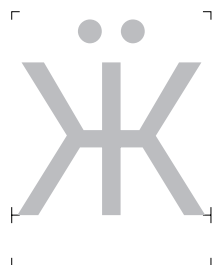

Zhedierescyrillic 04DC



Zedierescyrillic 04DE



uni04EC 04EC



Umacroncyrillic 04EE



Udierescyrillic 04F0



Uhungarumlautcyrillic 04F2

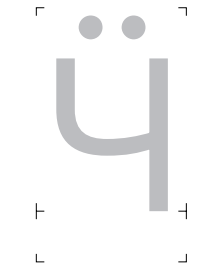

Chedierescyrillic 04F4



uni04F6 04F6



Yerudierescyrillic 04F8



uni04FE 04FE

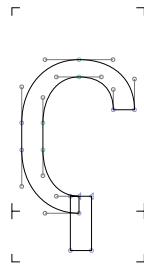

Koppacyrillic 0480



uni048C 048C

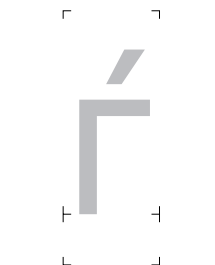

gjecyrillic 0453



iishortcyrillic 0439



uni045D 045D



kjecyrillic 045C

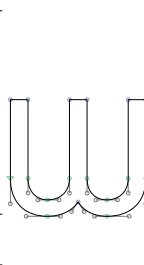

omegacyrillic 0461

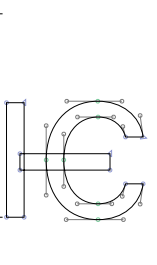

eiotifiedcyrillic 0465

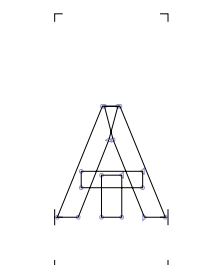

yuslitlecyrillic 0467

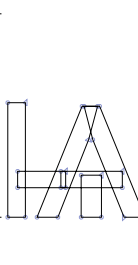

yuslitleiotifiedcyrillic 0469

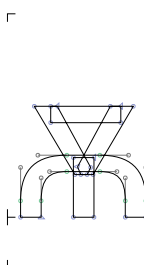

yusbigcyrillic 046B

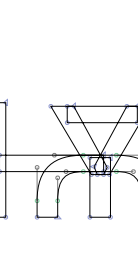

yusbigiotifiedcyrillic 046D

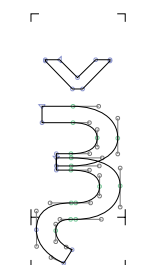

ksicyrillic 046F



psicyrillic 0471

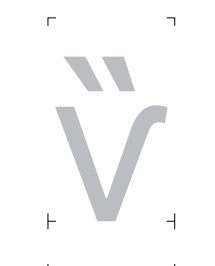

izhitsadblgravecyrillic 0477



ghestrokecyrillic 0493



zedescendercyrillic 0499



esdescendercyrillic 04AB



tedescendercyrillic 04AD



ustraightcyrillic 04AF

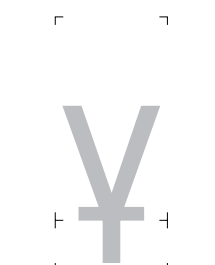

ustraightstrokecyrillic 04B1



chedescenderabkhasiancy 04BF



zhebrevcyrillic 04C2



chekhakassiancyrillic 04CC



schwacyrillic 04D9



schwadierescyrillic 04DB

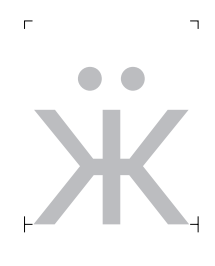

zhedierescyrillic 04DD



zedierescyrillic 04DF



imacroncyrillic 04E3



idierescyrillic 04E5



obarredcyrillic 04E9



obarreddierescyrillic 04EB

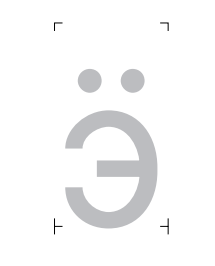

uni04ED 04ED



chedierescyrillic 04F5



uni04F7 04F7



yerudierescyrillic 04F9



uni04FF 04FF

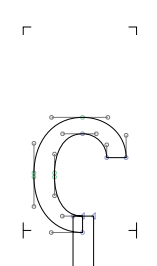

koppacyrillic 0481

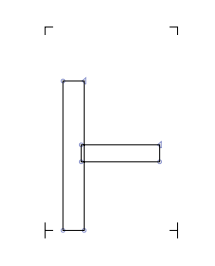

uni0370 0370

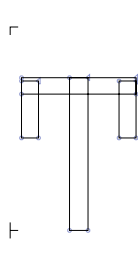

uni0372 0372

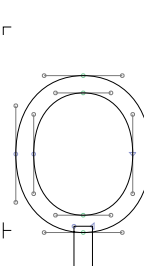



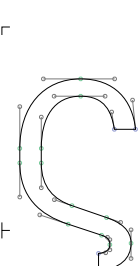

uni03D8 03D8

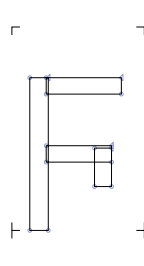

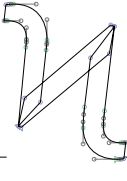
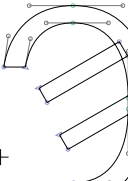
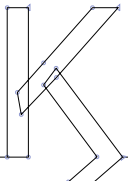

Stigma 03DA

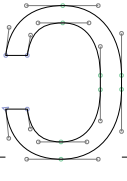



Digamma 03DC

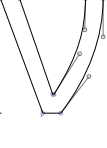
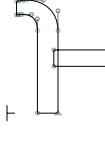
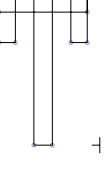

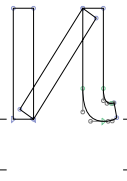
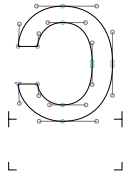
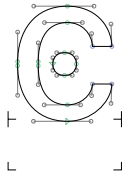
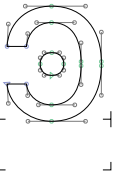
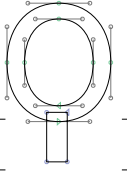
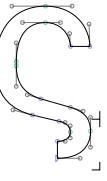

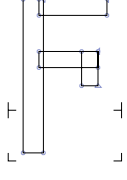
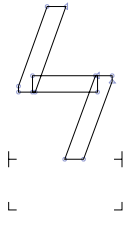
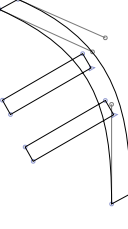
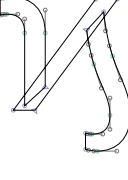
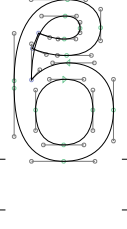
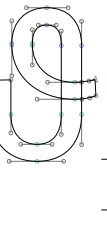

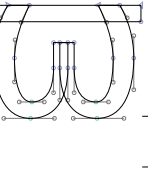
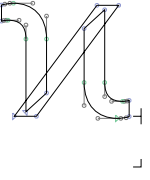
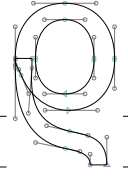
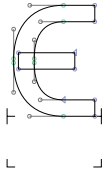
 **Koppa** 03DE  **Sampi** 03E0  **uni03CF** 03CF  **uni03F7** 03F7  **uni03FD** 03FD  **uni03FE** 03FE

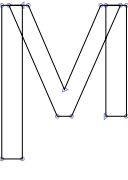



 **uni03FF** 03FF  **kappa** 03BA  **mugreek** 03BC  **nu** 03BD  **uni0371** 0371  **uni0373** 0373



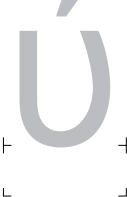

 **uni0377** 0377  **uni037B** 037B  **uni037C** 037C  **uni037D** 037D  **uni03D9** 03D9  **stigma** 03DB



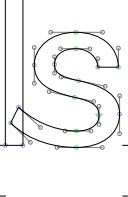

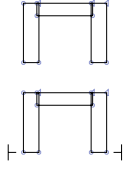
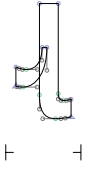

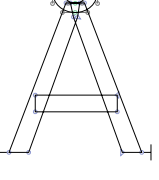
 **digamma** 03DD  **koppa** 03DF  **sampi** 03E1  **uni03D7** 03D7  **beta1** 03D0  **thetasymbolgreek** 03D1

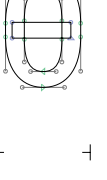
 **pisymbolgreek** 03D6  **kappa1** 03F0  **rho1** 03F1  **uni03F5** 03F5  **uni03F8** 03F8  **uni03FB** 03FB

 **uni1F71** 1F71  **uni1F73** 1F73  **uni1F75** 1F75  **uni1F77** 1F77  **uni1FD3** 1FD3  **uni1F79** 1F79

 **uni1F7B** 1F7B  **uni1FE3** 1FE3  **uni1F7D** 1F7D  **uni1FBE** 1FBE  **ypogegrammeni** 037A  **finalkaf** 02AA

 **finalmem** 02AD  **finaltsadi** 02B5  **qofdagesh** 02DF  **angstrom** 212B  **degreekelvin** 212A  **uni1DBF** 1DBF

 **romanone** 2160  **romantwo** 2161  **romanthree** 2162  **romanfour** 2163  **romanfive** 2164  **romansix** 2165

VII VIII IX X XI XII

romanseven 2166 romaneight 2167 romannine 2168 romanten 2169 romaneleven 216A romantwelve 216B

L C D M i ii

romanfifty 216C romanhundred 216D romanfivehundred 216E romanthousand 216F oneroman 2170 tworoman 2171

iii iv v vi vii viii

threeroman 2172 fourroman 2173 fiveroman 2174 sixroman 2175 sevenroman 2176 eightroman 2177

ix x xi xii l c

nineroman 2178 tenroman 2179 elevenroman 217A twelveroman 217B uni217C 217C uni217D 217D

d m [diagram of d] [diagram of m] [diagram of d]

uni217E 217E uni217F 217F uni2180 2180 uni2181 2181 uni2182 2182 uni2183 2183

[diagram of c] [diagram of arrow] [diagram of d] [diagram of d] asterism caretSign

uni2185 2185 uni2186 2186 uni2187 2187 uni2188 2188 asterism 2042 caretSign 2038

caretinsertionpoint charactertie hyphendot onedotleader overline referencemark

caretinsertionpoint 2041 charactertie 2040 hyphendot 2027 onedotleader 2024 overline 203E referencemark 203B

reversedsemicolon undertie uni204A uni204E uni2050 uni2051

reversedsemicolon 204F undertie 203F uni204A 204A uni204E 204E uni2050 2050 uni2051 2051





[diagram of wavy line] [diagram of arch] [diagram of asterisk] [diagram of dots] [diagram of dots]





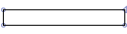

uni2053 2053 uni2054 2054 uni2055 2055 uni2056 2056 uni2058 2058 uni2059 2059







uni205A 205A	uni205B 205B	uni205C 205C	uni205D 205D	uni205E 205E	verticalbardbl 2016
hyphen_ 2010	hyphennobreak 2011	underscoredbl 2017	quotereversed 201B	quotedblreversed 201F	uni27EF 27EF
uniA92E A92E	uni2009.fra	afi300 200F	afi57596 200E	afi57598 200D	afi61664 200C
zerowidthjoiner FEFF	CR	eurocurrency 20A0	uni20B0 20B0	uni20B6 20B6	uni20B7 20B7
uni20BB 20BB	uni2052 2052	bullseye 0298	published 2117	lsquare 2113	estimated 212E
degreecentigrade 2103	degreefahrenheit 2109	ounce 2125	spaceopenbox 2423	uni214F 214F	uni2B4E 2B4E
uni2B4F 2B4F	uni2B5A 2B5A	uni2B5B 2B5B	uni2B5C 2B5C	uni2B5D 2B5D	uni2B5E 2B5E
uni2B5F 2B5F	versicle 2123	arrowheaddownmod 02C5	arrowheadleftmod 02C2	arrowheadrightmod 02C3	arrowheadupmod 02C4
dblapostrophe 02EE	downtackmod 02D5	lowdownarrowheadmod 02EF	minusmod 02D7	plusmod 02D6	rhotichookmod 02DE







ringhalfleftcentered 02D3	ringhalfrightcentered 02D2	uni02EA 02EA	uni02EB 02EB	uni02EC 02EC	uni02ED 02ED
uni02F0 02F0	uni02F1 02F1	uni02F2 02F2	uni02F3 02F3	uni02F4 02F4	uni02F5 02F5
uni02F6 02F6	uni02F7 02F7	uni02F8 02F8	uni02F9 02F9	uni02FA 02FA	uni02FB 02FB
uni02FC 02FC	uni02FD 02FD	uni02FE 02FE	uni02FF 02FF	uptackmod 02D4	tonebarextrahighmod.cn 02E5
tonebarextralowmod.cn 02E9	tonebarhighmod.cn 02E6	tonebarlowmod.cn 02E8	tonebarmidmod.cn 02E7	uni03F6 03F6	numeralgreek 0374
numeralgreeksub 0375	thousandcyrillic 0482	gammasuper 02E0	acutelowmod 02CF	colontriangularhalfmod 02D1	colontriangularmod 02D0
commareversedmod 02BD	commaturnedmod 02BB	firsttonechinese 02C9	fourthtonechinese 02CB	glottalstopmod 02C0	glottalstopreversedmod 02C1
gravelowmod 02CE	linevert 02C8	macronsub 02CD	ringhalfleft 02BF	ringhalfright 02BE	secondtonechinese 02CA
verticalinelowmod 02CC	overscorenosp 0305	linevertnosp 030D	linevertdblnosp 030E	candrabindunosp 0310	commaturnsupnosp 0312





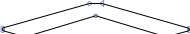

commaabovecmb 0313	commasuprevnosp 0314	commaaboverightcmb 0315	gravesubnosp 0316	acutesubnosp 0317	tackleftsubnosp 0318
tackrightsubnosp 0319	anglesupnosp 031A	ringlefthalfsubnosp 031C	tackupsubnosp 031D	tackdownsubnosp 031E	hooksubpalatnosp 0321
hooksubretronsp 0322	linevertsubnosp 0329	bridgesubnosp 032A	archdblsubnosp 032B	caronbelowcmb 032C	breveinvsubnosp 032F
macronsubnosp 0331	underscoredblno 0333	tildemidnosp 0334	barmidshortnosp 0335	barmidlongnosp 0336	slashshortnosp 0337
slashlongnosp 0338	ringrighthalfsubnosp 0339	bridgeinvsubnosp 033A	squaresubnosp 033B	seagullsubnosp 033C	xsupnosp 033D
tildevertsupnosp 033E	overscoredblno 033F	graveleftnosp 0340	acuterightnosp 0341	uni0346 0346	uni0348 0348
uni0349 0349	uni034A 034A	uni034B 034B	uni034C 034C	uni034D 034D	uni034E 034E
uni034F 034F	arrowheadrightabovecom 0350	uni0351 0351	uni0352 0352	uni0353 0353	uni0354 0354
uni0355 0355	uni0356 0356	uni0357 0357	uni0358 0358	uni0359 0359	uni035A 035A







					
+	+	+	+	+	+
-	-	-	-	-	-
uni035B 035B	uni035C 035C	uni035D 035D	uni035E 035E	uni035F 035F	tildedoublecmb 0360





					
+	+	+	+	+	+
-	-	-	-	-	-
breveinverteddoublecmb 0361	uni0362 0362	uni1DC0 1DC0	uni1DC1 1DC1	uni1DC2 1DC2	uni1DC3 1DC3





					
+	+	+	+	+	+
-	-	-	-	-	-
uni1DC4 1DC4	uni1DC5 1DC5	uni1DC6 1DC6	uni1DC7 1DC7	uni1DC8 1DC8	uni1DC9 1DC9

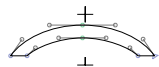
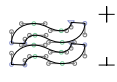



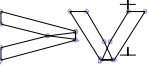

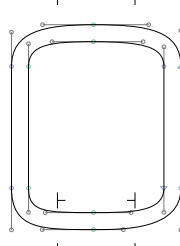
					
+	+	+	+	+	+
-	-	-	-	-	-
uni1DCB 1DCB	uni1DCC 1DCC	uni1DCD 1DCD	uni1DCE 1DCE	uni1DCF 1DCF	uni1DD0 1DD0

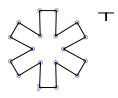
					
+	+	+	+	+	+
-	-	-	-	-	-
uni1DD1 1DD1	uni1DD2 1DD2	uni1DE8 1DE8	uni1DEA 1DEA	uni1DEB 1DEB	uni1DEC 1DEC

					
+	+	+	+	+	+
-	-	-	-	-	-
uni1DED 1DED	uni1DEE 1DEE	uni1DEF 1DEF	uni1DF0 1DF0	uni1DF1 1DF1	uni1DF2 1DF2

					
+	+	+	+	+	+
-	-	-	-	-	-
uni1DF3 1DF3	uni1DF4 1DF4	uni1DF5 1DF5	uni1DFC 1DFC	uni1DFD 1DFD	uni1DFE 1DFE

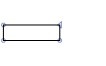
					
+	+	+	+	+	+
-	-	-	-	-	-
uni1DFF 1DFF	uni20DB 20DB	uni20DC 20DC	uni20E3 20E3	uni20E8 20E8	uni20F0 20F0

					
+	+	+	+	+	+
-	-	-	-	-	-
uniFE20 FE20	uniFE21 FE21	uniFE22 FE22	uniFE23 FE23	uniFE24 FE24	uniFE25 FE25

uniFE26 FE26	uniFE27 FE27	uniFE28 FE28	uniFE29 FE29	uniFE2A FE2A	uniFE2B FE2B	
uniFE2C FE2C	uniFE2D FE2D	macronacutecomb.cn	macrongravecomb.cn	macronacutecomb.lc	macrongravecomb.lc	
perispomenigreekcmb 0342	koroniscmb 0343	diaeresistonosp 0344	iotasubnosp 0345	uni1FBF 1FBF	uni1FBD 1FBD	
uni1FFE 1FFE	uni1FCD 1FCD	uni1FDD 1FDD	uni1FCE 1FCE	uni1FDE 1FDE	uni1FCF 1FCF	
uni1FDF 1FDF	uni1FED 1FED	uni1FEE 1FEE	uni1FC1 1FC1	uni1FEF 1FEF	uni1FFD 1FFD	
uni1FC0 1FC0	uni1FFE.tonos	uni1FCD.tonos	uni1FDD.tonos	uni1FCE.tonos	uni1FDE.tonos	
uni1FCF.tonos	uni1FDF.tonos	uni1FEF.tonos	uni1FFD.tonos	titlocyrilliccmb 0483	palatalizationcyrilliccmb 0484	
dasiapneumatacyrilliccmb0485	psilipneumatacyrilliccmb 0486	uni0487 0487	uni0488 0488	uni0489 0489	uniA69F A69F	
uni0363 0363	uni0364 0364	uni0365 0365	uni0366 0366	uni0367 0367	uni0368 0368	

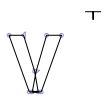
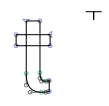
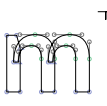
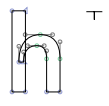
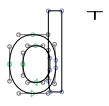

uni0369 0369

uni036A 036A

uni036B 036B

uni036C 036C

uni036D 036D

uni036E 036E

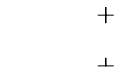
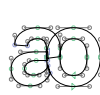
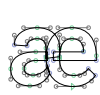

uni036F 036F

uni1DCA 1DCA

uni1DD3 1DD3

uni1DD4 1DD4

uni1DD5 1DD5

uni1DD6 1DD6

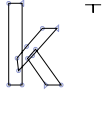
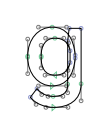
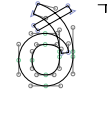
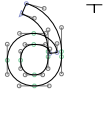
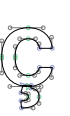

uni1DD7 1DD7

uni1DD8 1DD8

uni1DD9 1DD9

uni1DDA 1DDA

uni1ddb 1ddb

uni1DDC 1DDC

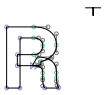
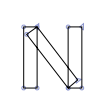
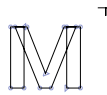
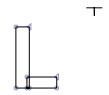

uni1DDD 1DDD

uni1DDE 1DDE

uni1DDF 1DDF

uni1DE0 1DE0

uni1DE1 1DE1

uni1DE2 1DE2

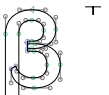
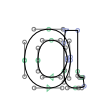
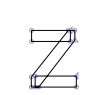
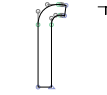
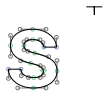

uni1DE3 1DE3

uni1DE4 1DE4

uni1DE5 1DE5

uni1DE6 1DE6

uni1DE7 1DE7

uni1DE9 1DE9

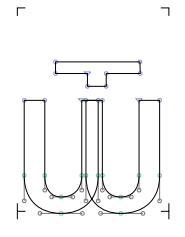
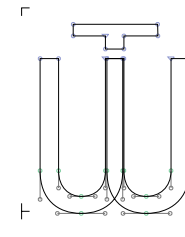
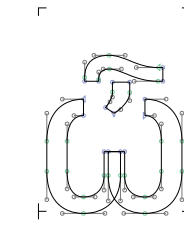
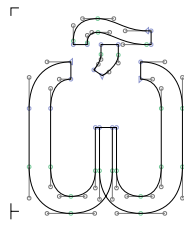
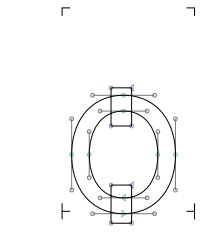
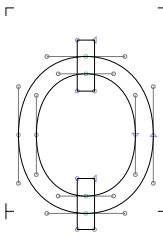

Omeгарoundcyrillic 047A

omegaroundcyrillic 047B

Omeɡatitlocyrillic 047C

omeɡatitlocyrillic 047D

Otcyrillic 047E

otcyrillic 047F

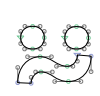
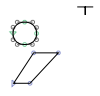
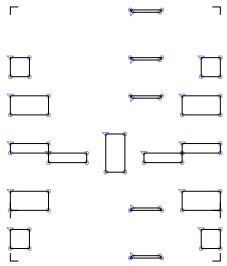

uni2DFF 2DFF

uniE001 E001

crossbar

acutedotcomb.lc

tildedieresiscomb.lc

dieresisacutecomb.lc



carondotcomb.lc

caronosp

caronsubnosp

ascript_uni02DE

cyrillichookleft

dotmacroncomb.lc

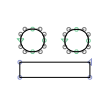
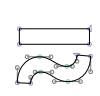
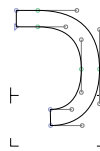

dieresismacroncomb.lc

dieresisgravecomb.lc

largerighthook

tildemacroncomb.lc

macrondieresiscomb.lc

tildeacutecomb

dieresiscaroncomb.lc	cyrillichook	cyrillictic.cn	controlHT	controlSOT	commaaccentright.cn
ringacute.cn	circumflexgravecomb.cn	dieresiscaroncomb.cn	dieresismacroncomb.cn	carondotcomb.cn	breveacutecomb.cn
acutedotcomb.cn	brevegravecomb.cn	circumflexacutecomb.cn	tildedieresiscomb.cn	circumflexhookcomb.cn	brevetildecomb.cn
dieresisacutecomb.cn	dotmacroncomb.cn	macrondieresiscomb.cn	dieresisgravecomb.cn	tildemacroncomb.cn	circumflextildecomb.cn
brevehookcomb.cn	commaaccentrotate.cn	tonostop	cyrillictail.cn	koronisaccentleft.cn	tildeacutecomb.uc