

A 0041	Adieresis 00C4	Atilde 00C3	Agrave 00C0	Aacute 00C1	Acircumflex 00C2
Aring 00C5	Amacron 0100	Abreve 0102	Aogonek 0104	Acaron 01CD	Adieresismacron 01DE
Adotmacron 01E0	Aringacute 01FA	Adblgrave 0200	Ainvertedbreve 0202	uni0226 0226	Aringbelow 1E00
Adotbelow 1EA0	Ahookabove 1EA2	Acircumflexacute 1EA4	Acircumflexgrave 1EA6	Acircumflexhookabove 1EA8	Acircumflextilde 1EAA
Acircumflexdotbelow 1EAC	Abreveacute 1EAE	Abrevegrave 1EB0	Abrevehookabove 1EB2	Abrevetilde 1EB4	Abrevedotbelow 1EB6
Alpha 0391	Alphanos 0386	uni1F08 1F08	uni1F09 1F09	uni1F0A 1F0A	uni1F0B 1F0B
uni1F0C 1F0C	uni1F0D 1F0D	uni1F0E 1F0E	uni1F0F 1F0F	uni1FB8 1FB8	uni1FB9 1FB9
uni1FBA 1FBA	uni023A 023A	uni1FBB 1FBB	afii10017 0410	Abrevecyrillic 04D0	Adieresiscyrillic 04D2
uni1F88 1F88	uni1F89 1F89	uni1F8A 1F8A	uni1F8B 1F8B	uni1F8C 1F8C	uni1F8D 1F8D



uni1F8E 1F8E



uni1F8F 1F8F

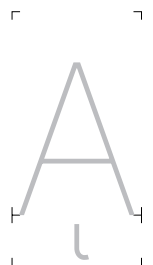

uni1FBC 1FBC

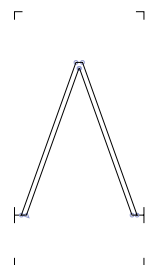

Lambda 039B

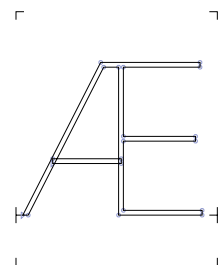

AE 00C6

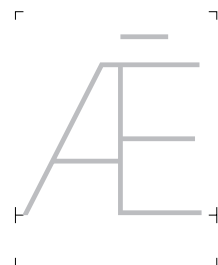

AEmacron 01E2

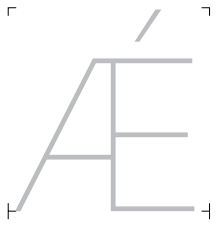

AEacute 01FC



Aiecyrillic 04D4

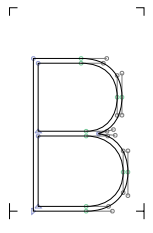

B 0042



Bdotaccent 1E02

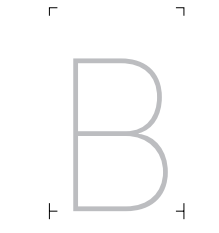

Bdotbelow 1E04

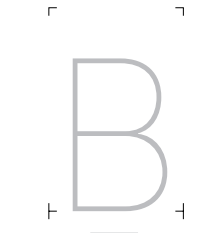

Blinebelow 1E06



uni0243 0243



Bhook 0181



afii10019 0412



Beta 0392

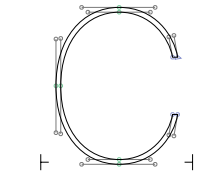

C 0043

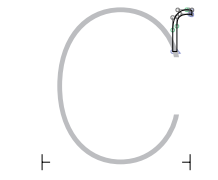

Chook 0187

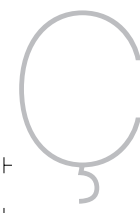

Ccedilla 00C7



Cacute 0106

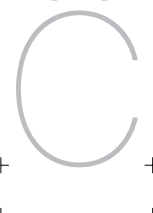

Ccircumflex 0108

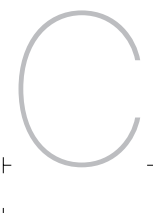

Cdotaccent 010A

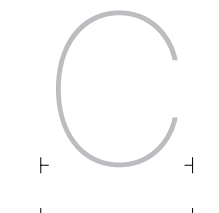

Ccaron 010C

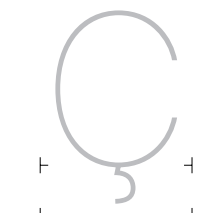

Ccedillaacute 1E08

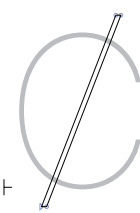

uni023B 023B

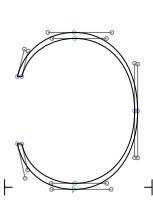

Oopen 0186



uni03F9 03F9

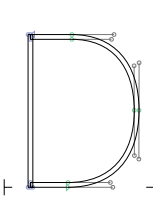

D 0044

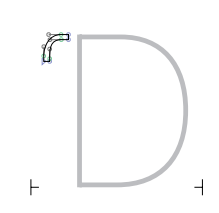

Dhook 018A

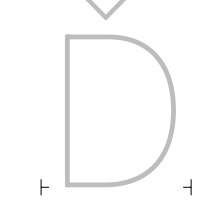

Dcaron 010E



Ddotaccent 1E0A



Ddotbelow 1E0C



Dlinebelow 1E0E



Dcedilla 1E10

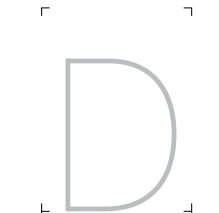

Dcircumflexbelow 1E12

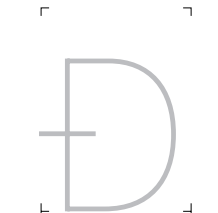

Dbar1 0189



Dz 01F2



Dzcaron_ 01C5

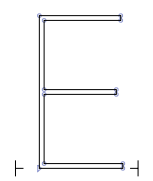

E 0045



Egrave 00C8

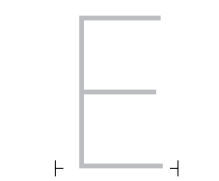

Eacute 00C9

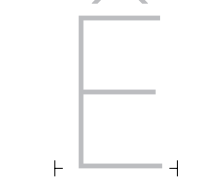

Ecircumflex 00CA



Edieresis 00CB



Emacron 0112



Ebreve 0114



Edotaccent 0116

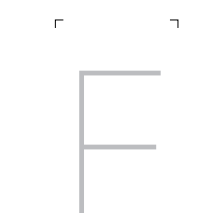

Eogonek 0118

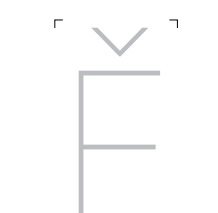

Ecaron 011A



Edblgrave 0204



Einvertedbreve 0206



uni0228 0228



Emacrongrave 1E14

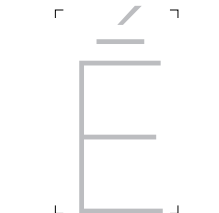

Emacronacute 1E16

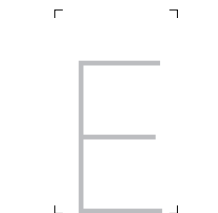

Ecircumflexbelow 1E18

Etildebelow 1E1A Ecedillabreve 1E1C Edotbelow 1EB8 Ehookabove 1EBA Etilde 1EBC Ecircumflexacute 1EBE

Ecircumflexgrave 1EC0 Ecircumflexhookabove 1EC2 Ecircumflextilde 1EC4 Ecircumflexdotbelow 1EC6 uni0246 0246 Eturn 018E

Epsilon 0395 Epsilontonos 0388 uni1F18 1F18 uni1F19 1F19 uni1F1A 1F1A uni1F1B 1F1B

uni1F1C 1F1C uni1F1D 1F1D uni1FC8 1FC8 uni1FC9 1FC9 afii10022 0415 uni0400 0400

afii10023 0401 lebrevecyrillic 04D6 F 0046 Fhook 0191 Fdotaccent 1E1E Fturn 2132

G 0047 Gbar 01E4 Ghook 0193 Gcircumflex 011C Gbreve 011E Gdotaccent 0120

Gcommaaccent 0122 Gcaron 01E6 Gacute 01F4 Gmacron 1E20 G.1 Gbar.1

Ghook.1 Gcircumflex.1 Gbreve.1 Gdotaccent.1 Gcommaaccent.1 Gcaron.1

Gacute.1 Gmacron.1 H 0048 Hcedilla 1E28 Hcircumflex 0124 uni021E 021E

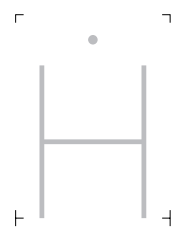

Hdotaccent 1E22



Hdotbelow 1E24

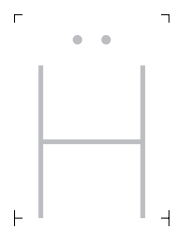

Hdieresis 1E26



Hbrevebelow 1E2A

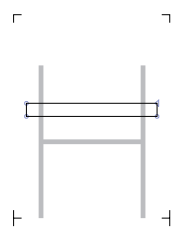

Hbar 0126



Enhookcyrillic 04C7

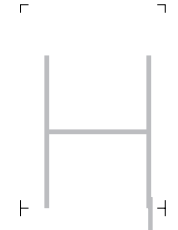

Endescendercyrillic 04A2

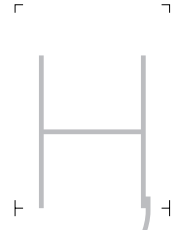

uni04C9 04C9

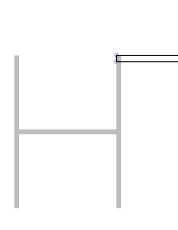

Enghecyrillic 04A4

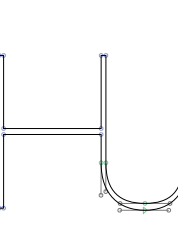

uni01F6 01F6

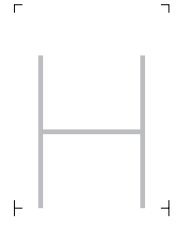

Eta 0397

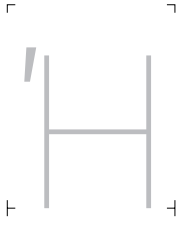

Etatonos 0389



uni1F28 1F28



uni1F29 1F29



uni1F2A 1F2A



uni1F2B 1F2B



uni1F2C 1F2C



uni1F2D 1F2D



uni1F2E 1F2E



uni1F2F 1F2F



uni1FCA 1FCA



uni1FCB 1FCB

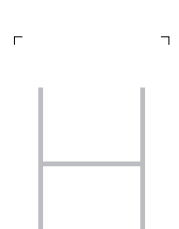

afi10031 041D



uni1F98 1F98



uni1F99 1F99



uni1F9A 1F9A



uni1F9B 1F9B



uni1F9C 1F9C



uni1F9D 1F9D



uni1F9E 1F9E



uni1F9F 1F9F

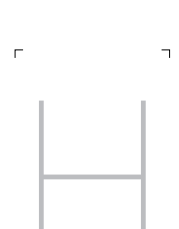

uni1FCC 1FCC

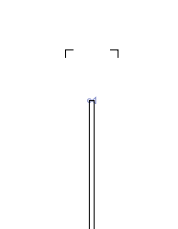

I 0049

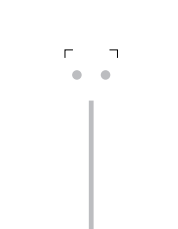

Idieresis 00CF

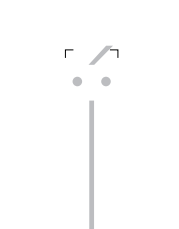

Idieresisacute 1E2E

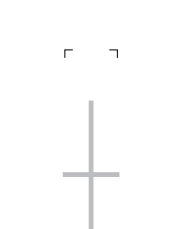

Istroke 0197

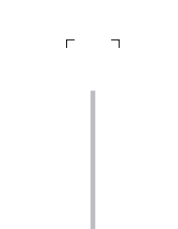

Itildebelow 1E2C

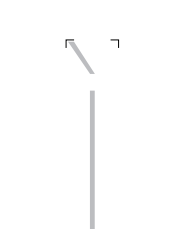

Igrave 00CC

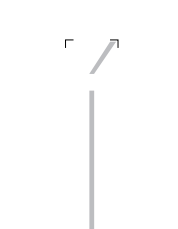

Iacute 00CD

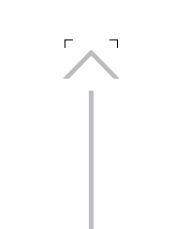

Icircumflex 00CE

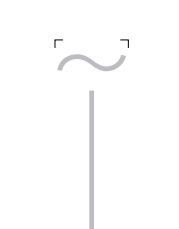

Itilde 0128



Imacron 012A



Ibreve 012C

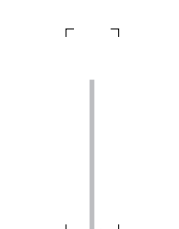

Iogonek 012E

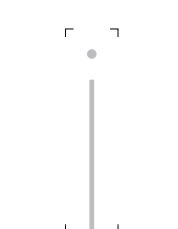

Idotaccent 0130

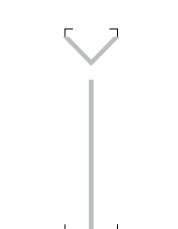

Icaron 01CF

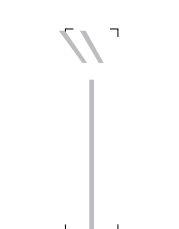

Idblgrave 0208



Iinvertedbreve 020A

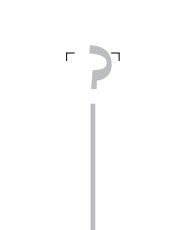

Ihookabove 1EC8

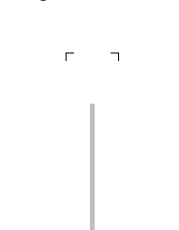

Idotbelow 1ECA

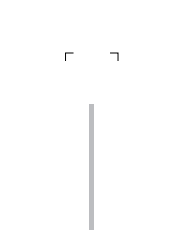

Iota 0399



Iotatonos 038A

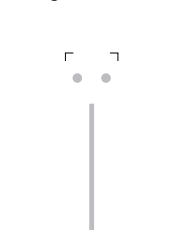

Iotadieresis 03AA



uni1F38 1F38

uni1F39 1F39 uni1F3A 1F3A uni1F3B 1F3B uni1F3C 1F3C uni1F3D 1F3D uni1F3E 1F3E

uni1F3F 1F3F uni1FD8 1FD8 uni1FD9 1FD9 uni1FDA 1FDA uni1FDB 1FDB afii10055 0406

afii10056 0407 **l.1** **ldieresis.1** **ldieresisacute.1** **lstroke.1** **ltildebelow.1**

lgrave.1 **lacute.1** **lcircumflex.1** **ltilde.1** **lmacron.1** **lbreve.1**













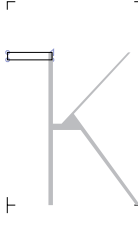

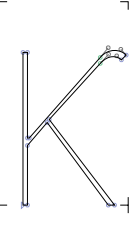

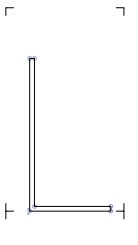







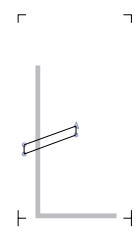

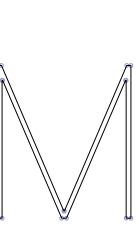







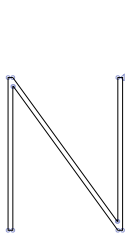















logonek.1 **ldotaccent.1** **lcaron.1** **ldblgrave.1** **lvertedbreve.1** **lhookabove.1**



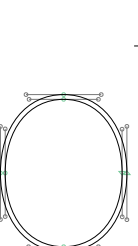

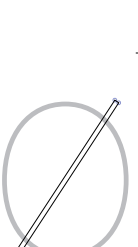
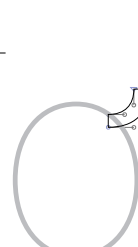

ldotbelow.1 **uni1F38.1** **uni1F39.1** **uni1F3A.1** **uni1F3B.1** **uni1F3C.1**



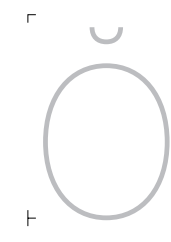
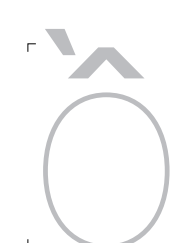
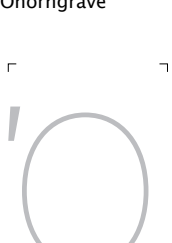







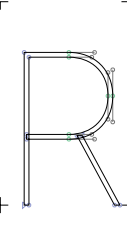









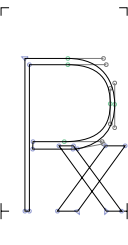
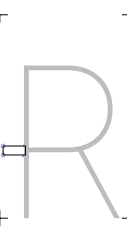
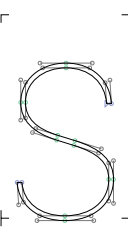











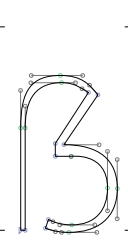
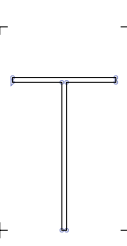







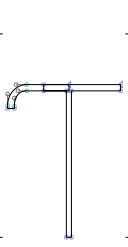



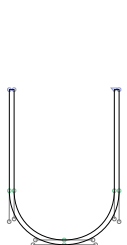
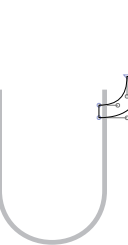



uni1F3D.1 **uni1F3E.1** **uni1F3F.1** **uni1FD8.1** **uni1FD9.1** **uni1FDA.1**



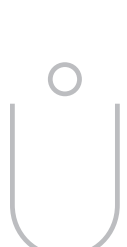







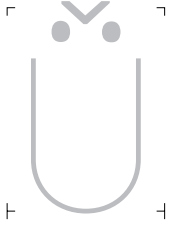
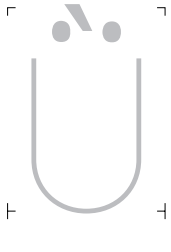
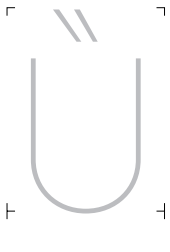
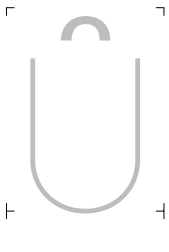
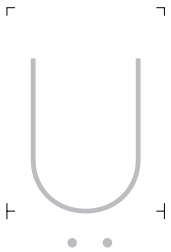
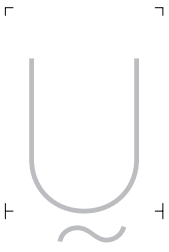
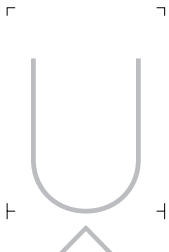
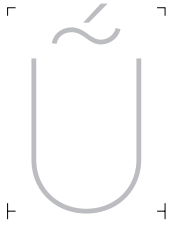
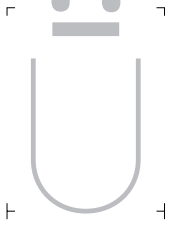
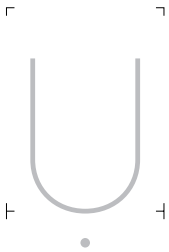
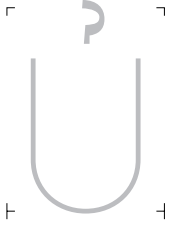





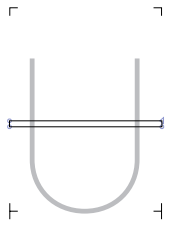
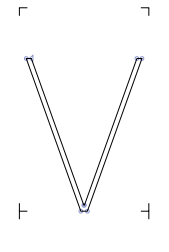

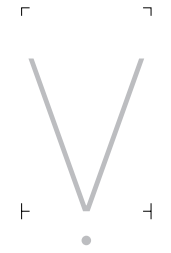
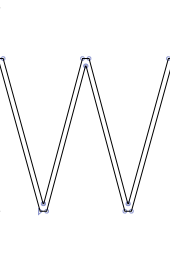

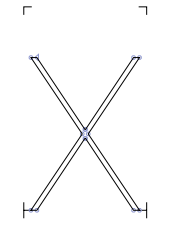
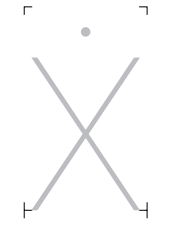
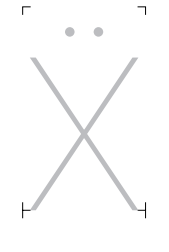
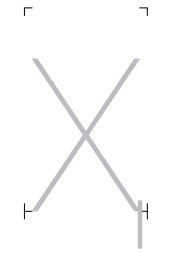
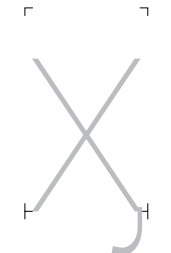
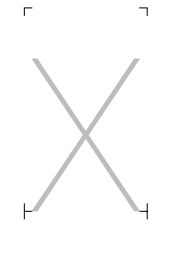
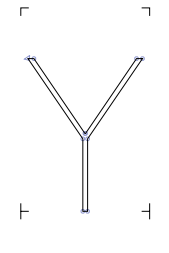
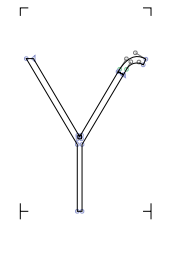
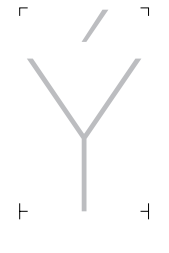
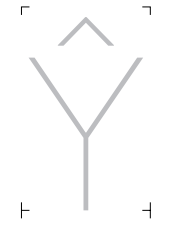
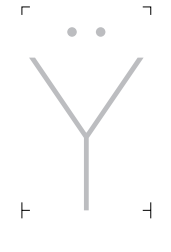

uni1FDB.1 **afii10055.1** **afii10056.1** **J 004A** **Jcircumflex 0134** **uni0248 0248**

uni037F 037F **afii10057 0408** **K 004B** **Kcommaaccent 0136** **Kcaron 01E8** **Kacute 1E30**

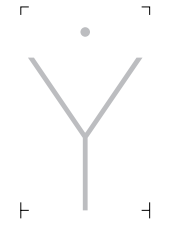
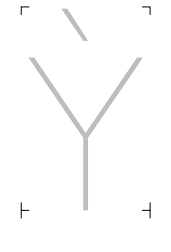
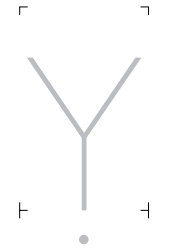
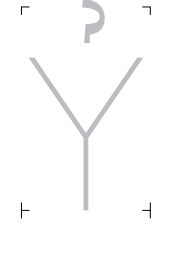
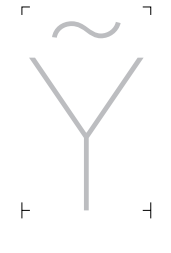
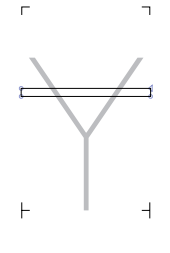
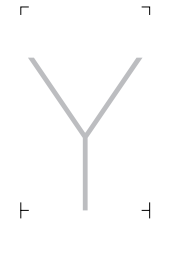
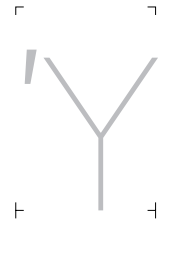
					
Kdotbelow 1E32	Klinebelow 1E34	Kabashkircyrillic 04A0	Kadescendcyrillic 049A	Khook 0198	Kappa 039A
					
L 004C	Lacute 0139	Lcommaaccent 013B	Lcaron 013D	Ldotbelow 1E36	Ldotbelowmacron 1E38
					
Llinebelow 1E3A	Lcircumflexbelow 1E3C	Lslash 0141	Lbar 023D	Lj 01C8	M 004D
					
Macute 1E3E	Mdotaccent 1E40	Mdotbelow 1E42	uni04CD 04CD	Mu 039C	uni03FA 03FA
					
afii10030 041C	N 004E	Ntilde 00D1	Nacute 0143	Ncommaaccent 0145	Ncaron 0147
					
uni01F8 01F8	Ndotaccent 1E44	Ndotbelow 1E46	Nlinebelow 1E48	Ncircumflexbelow 1E4A	Nhook 019D
					
Eng 014A	afii10026 0418	uni040D 040D	afii10027 0419	Imacroncyrillic 04E2	Idieresiscyrillic 04E4
					
uni048A 048A	uni0376 0376	Nu 039D	Nj 01CB	O 004F	Odieresis 00D6
					
Otilde 00D5	Oslash 00D8	Ohorn 01A0	Ograve 00D2	Oacute 00D3	Ocircumflex 00D4

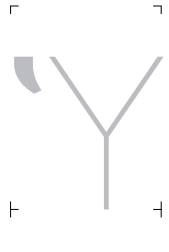
					
Omacron 014C	Obreve 014E	Ohungarumlaut 0150	Ocaron 01D1	Oogonek 01EA	Oogonekmacron 01EC
					
Odblgrave 020C	Oinvertedbreve 020E	uni022A 022A	uni022C 022C	uni022E 022E	uni0230 0230
					
Otildeacute 1E4C	Otildedieresis 1E4E	Omacrongrave 1E50	Omacronacute 1E52	Odotbelow 1ECC	Ohookabove 1ECE
					
Ocircumflexacute 1ED0	Ocircumflexgrave 1ED2	Ocircumflexhookabove 1ED4	Ocircumflextilde 1ED6	Ocircumflexdotbelow 1ED8	Ohornacute 1EDA
					
Ohorngrave 1EDC	Ohornhookabove 1EDE	Ohorntilde 1EE0	Ohorndotbelow 1EE2	Oslashacute 01FE	Omicron 039F
					
Omicrontonos 038C	uni1F48 1F48	uni1F49 1F49	uni1F4A 1F4A	uni1F4B 1F4B	uni1F4C 1F4C
					
uni1F4D 1F4D	uni1FF8 1FF8	uni03F4 03F4	uni1FF9 1FF9	afi10032 041E	Odiereiscyrillic 04E6
					
Obar 019F	Obarredcyrillic 04E8	Obarreddiereiscyrillic 04EA	OE 0152	P 0050	Pacute 1E54
					
Pdotaccent 1E56	uni048E 048E	Phook 01A4	Rho 03A1	uni1FEC 1FEC	Q 0051

					
R 0052	Racute 0154	Rcommaaccent 0156	Rcaron 0158	Rdblgrave 0210	Rinvertedbreve 0212
					
Rdotaccent 1E58	Rdotbelow 1E5A	Rdotbelowmacron 1E5C	Rlinebelow 1E5E	response 211F	Rx 211E
					
uni024C 024C	S 0053	Sacute 015A	Scircumflex 015C	Scedilla 015E	Scaron 0160
					
Scommaaccent 0218	Sdotaccent 1E60	Sdotbelow 1E62	Sacutedotaccent 1E64	Scarondotaccent 1E66	Sdotbelowdotaccent 1E68
					
afii10054 0405	Tonetwo 01A7	Germandbls 1E9E	T 0054	Tcommaaccent 0162	Tcaron 0164
					
uni021A 021A	Tdotaccent 1E6A	Tdotbelow 1E6C	Tlinebelow 1E6E	Tcircumflexbelow 1E70	Thook 01AC
					
Trhook 01AE	uni023E 023E	Tau 03A4	U 0055	Uhorn 01AF	Ugrave 00D9
					
Uacute 00DA	Ucircumflex 00DB	Udieresis 00DC	Utilde 0168	Umacron 016A	Ubreve 016C
					
Uring 016E	Uhungarumlaut 0170	Uogonek 0172	Ucaron 01D3	Udieresismacron 01D5	Udieresisacute 01D7

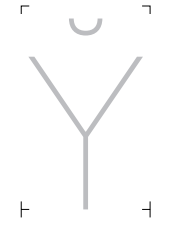
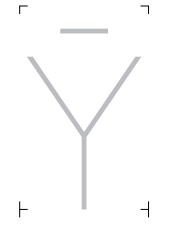
					
Udieresiscaron 01D9	Udieresisgrave 01DB	Udblgrave 0214	Uinvertedbreve 0216	Udieresisbelow 1E72	Utildebelow 1E74
					
Ucircumflexbelow 1E76	Utildeacute 1E78	Umacrondieresis 1E7A	Udotbelow 1EE4	Uhookabove 1EE6	Uhornacute 1EE8
					
Uhorngrave 1EEA	Uhornhookabove 1EEC	Uhorntilde 1EEE	Uhorndotbelow 1EF0	uni0244 0244	V 0056
					
Vtilde 1E7C	Vdotbelow 1E7E	W 0057	Wcircumflex 0174	Wgrave 1E80	Wacute 1E82
					
Wdieresis 1E84	Wdotaccent 1E86	Wdotbelow 1E88	X 0058	Xdotaccent 1E8A	Xdieresis 1E8C
					
Hadesdescendercyrillic 04B2	uni04FC 04FC	Chi 03A7	Y 0059	Yhook 01B3	Yacute 00DD
					
Ycircumflex 0176	Ydieresis 0178	uni0232 0232	Ydotaccent 1E8E	Ygrave 1EF2	Ydotbelow 1EF4
					
Yhookabove 1EF6	Ytilde 1EF8	uni024E 024E	Upsilon 03A5	Upsilontonos 038E	Upsilondieresis 03AB
					
uni1F59 1F59	uni1F5B 1F5B	uni1F5D 1F5D	uni1F5F 1F5F	uni1FE8 1FE8	uni1FE9 1FE9



uni1FEA 1FEA



uni1FEB 1FEB

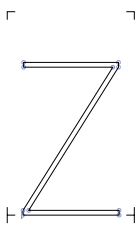

Z 005A



Zacute 0179



Zdotaccent 017B



Zcaron 017D



Zcircumflex 1E90



Zdotbelow 1E92



Zlinebelow 1E94

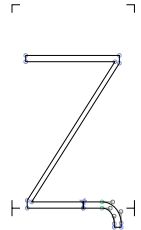

uni0224 0224



Zbar 01B5



Zeta 0396

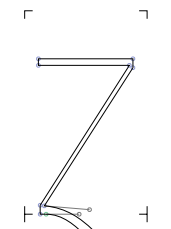

uni2C7F 2C7F

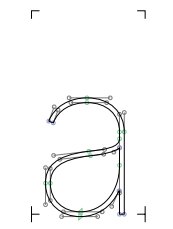

a 0061



aacute 00E1



abreve 0103



abreveacute 1EAF



abrevedotbelow 1EB7

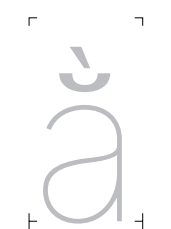

abrevegrave 1EB1



abrevehookabove 1EB3



abrevetilde 1EB5



acaron 01CE



acircumflex 00E2



acircumflexacute 1EA5



acircumflexdotbelow 1EAD



acircumflexgrave 1EA7



acircumflexhookabove 1EA9



acircumflextilde 1EAB



addgrave 0201



adieresis 00E4



adieresismacron 01DF



uni0227 0227



adotbelow 1EA1



adotmacron 01E1



agrave 00E0



ahookabove 1EA3



ainvertedbreve 0203

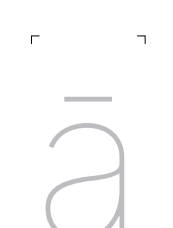

amacron 0101



aogonek 0105



aringhalfring 1E9A



aring 00E5



aringacute 01FB



aringbelow 1E01

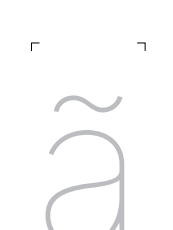

atilde 00E3



aturn 0250



afii10065 0430



abrevecyrillic 04D1



adieresiscyrillic 04D3

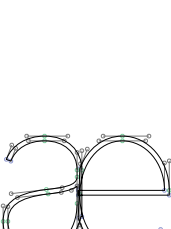

ae 00E6



aemacron 01E3



aeacute 01FD



aiecyrillic 04D5

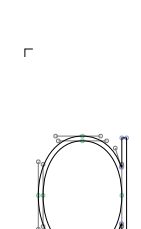

a.1



aacute.1



abreve.1



abreveacute.1



abrevedotbelow.1



abrevegrave.1



abrevehookabove.1



abrevetilde.1



acaron.1



acircumflex.1



acircumflexacute.1



acircumflexdotbelow.1



acircumflexgrave.1



acircumflexhookabove.1



acircumflextilde.1



adblgrave.1



adieresis.1



adieresismacron.1



uni0227.1



adotbelow.1



adotmacron.1



agrave.1



ahookabove.1



ainvertedbreve.1



amacron.1



aogonek.1



arighthalfring.1



aring.1



aringacute.1



aringbelow.1



atilde.1

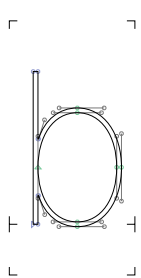

b 0062



bbar 0180

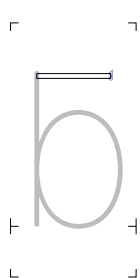

btopbar 0183

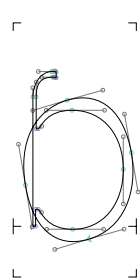

bhook 0253



bdotaccent 1E03



bdotbelow 1E05



blinebelow 1E07

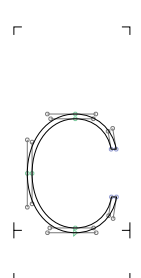

c 0063

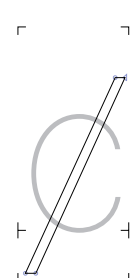

uni023C 023C



chook 0188

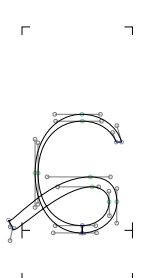

ccurl 0255



ccedilla 00E7



cacute 0107



ccircumflex 0109



ccdotaccent 010B



ccaron 010D



ccedillaacute 1E09



sigmalunatesymbolgreek 03F2



escyrillic 0441

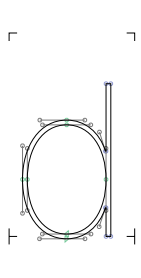

d 0064



dcroat 0111



drthook 0256

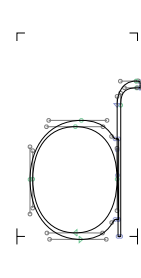

dhook 0257



dtopbar 018C



uni0221 0221

dcaron 010F	ddotaccent 1E0B	ddotbelow 1E0D	dlinebelow 1E0F	dcedilla 1E11	dcircumflexbelow 1E13
dz 02A3	dzcaron 01C6	dzcurl 02A5	dyogh 02A4	dong 20AB	e 0065
edieresis 00EB	uni0247 0247	egrave 00E8	eacute 00E9	ecircumflex 00EA	emacron 0113
ebreve 0115	edotaccent 0117	eogonek 0119	ecaron 011B	edblgrave 0205	einvertedbreve 0207
uni0229 0229	emacrongrave 1E15	emacronacute 1E17	ecircumflexbelow 1E19	etildebelow 1E1B	ecedillabreve 1E1D
edotbelow 1EB9	ehookabove 1EBB	etilde 1EBD	ecircumflexacute 1EBF	ecircumflexgrave 1EC1	ecircumflexhookabove 1EC3
ecircumflextilde 1EC5	ecircumflexdotbelow 1EC7	iecyrrilic 0435	uni0450 0450	iocyrillic 0451	iebrevecyrrilic 04D7
eth 01DD	_part.f_base	f 0066	slongstroke 1E9C	slongdotaccent 1E9B	fdotaccent 1E1F
f with g 02A9	g 0067	ghook 0260	gbar 01E5	gcircumflex 011D	gbreve 011F



gdotaccent 0121



gcommaaccent 0123



gcaron 01E7



gacute 01F5



gmacron 1E21

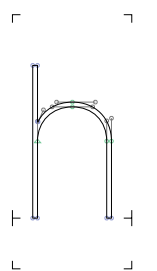

h 0068



hcedilla 1E29

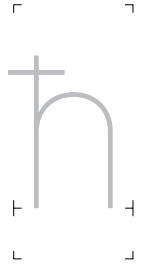

tshecyrillic 045B

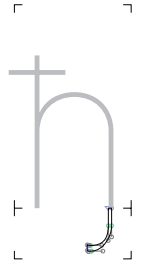

djecyrillic 0452

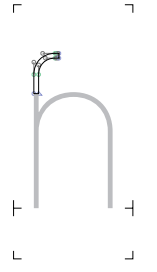

hhook 0266

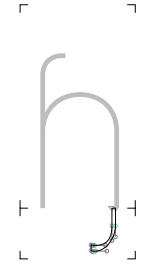

henghook 0267

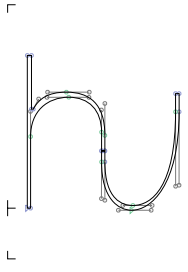

hv 0195

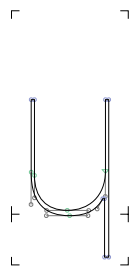

hturn 0265

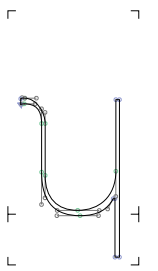

hturnlhook 02AE

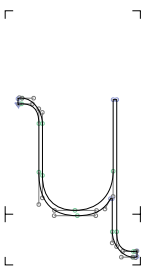

hturnhook2 02AF

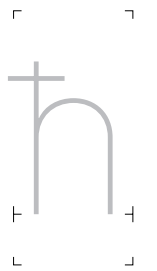

hbar 0127

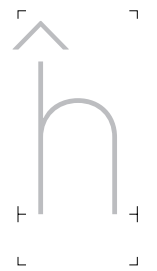

hcircumflex 0125



uni021F 021F



hdotaccent 1E23



hdotbelow 1E25



hdieresis 1E27



hbrevebelow 1E2B

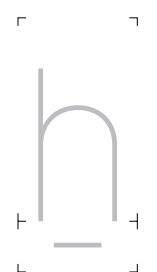

hlinebelow 1E96



shhacyrillic 04BB



i 0069

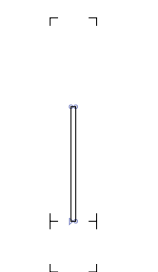

idotless 0131



idieresis 00EF



idieresisacute 1E2F



itilde 0129



itildebelow 1E2D



uni1E2D.ccmp

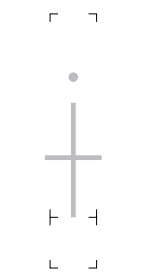

ibar 0268



igrave 00EC



iacute 00ED

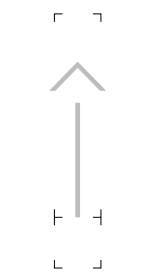

icircumflex 00EE



imacron 012B



ibreve 012D



uni012F.ccmp



iogonek 012F



icaron 01D0



idblgrave 0209



iinvertedbreve 020B



ihookabove 1EC9



idotbelow 1ECB



uni1ECB.ccmp

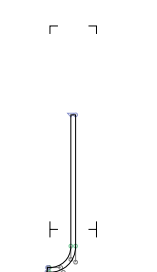

jdotless 0237



jdotlessbar 025F



uni0249 0249



uni0249.ccmp



icyrillic 0456



yicyrillic 0457

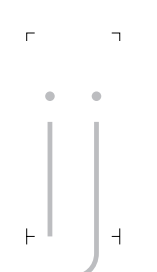

ij 0133



j 006A

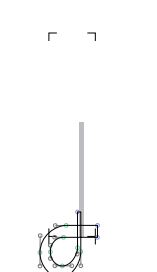

jcrosstail.ccmp

jcrossail 029D jcircumflex 0135 jcaron 01F0 yotgreek 03F3 jecyrillic 0458 lj 01C9

k 006B khook 0199 kcommaaccent 0137 kcaron 01E9 kacute 1E31 kdotbelow 1E33

klinebelow 1E35 kturn 029E l 006C lslash 0142 lbar 019A lmidtilde 026B

lrhook 026D lbelt 026C lcurl 0234 ldot 0140 lacute 013A lcommaaccent 013C

lcaron 013E ldotbelow 1E37 ldotbelowmacron 1E39 llinebelow 1E3B lcircumflexbelow 1E3D l.ss02

lslash.ss02 lbar.ss02 lmidtilde.ss02 lbelt.ss02 ldot.ss02 lacute.ss02

lcommaaccent.ss02 lcaron.ss02 ldotbelow.ss02 ldotbelowmacron.ss02 llinebelow.ss02 lcircumflexbelow.ss02

uni04CF 04CF m 006D mhook 0271 mturn 026F mturndescend 0270 macute 1E3F

mdotaccent 1E41 mdotbelow 1E43 n 006E ntilde 00F1 nrhook 0273 eng 014B

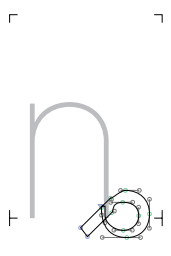

ncurl 0235



nlft hook 0272



nletrightlong 019E



nacute 0144



ncommaaccent 0146

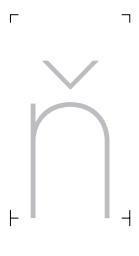

ncaron 0148

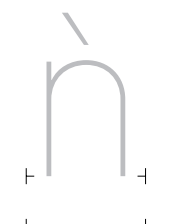

uni01F9 01F9



ndotaccent 1E45



ndotbelow 1E47



nlinebelow 1E49



ncircumflexbelow 1E4B



nj 01CC

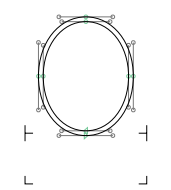

o 006F

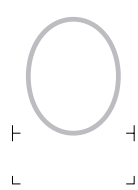

odieresis 00F6

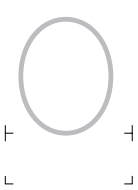

otilde 00F5

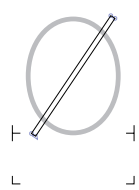

oslash 00F8

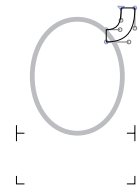

ohorn 01A1

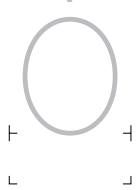

ograve 00F2

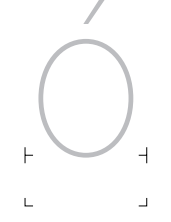

oacute 00F3

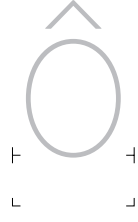

ocircumflex 00F4

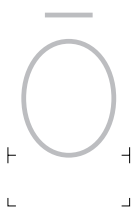

omacron 014D

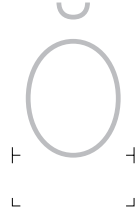

obreve 014F

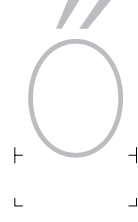

ohungarumlaut 0151

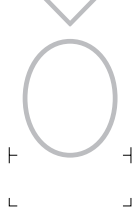

ocaron 01D2



oogonek 01EB



oogonekmacron 01ED

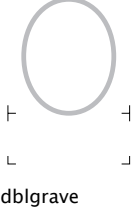

odblgrave 020D

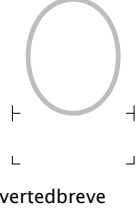

oinvertedbreve 020F

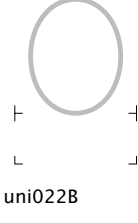

uni022B 022B

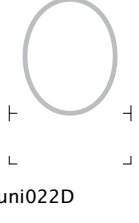

uni022D 022D

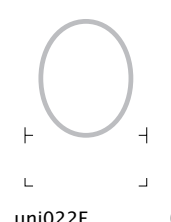

uni022F 022F

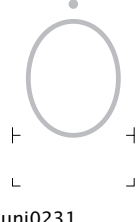

uni0231 0231

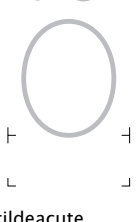

otildeacute 1E4D

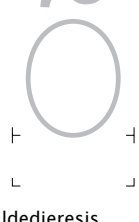

otildedieresis 1E4F

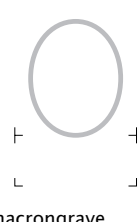

omacrongrave 1E51

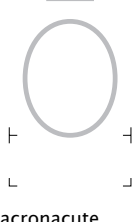

omacronacute 1E53

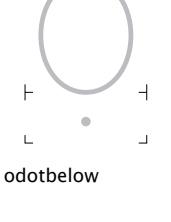

odotbelow 1ECD



ohookabove 1ECF

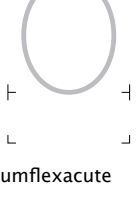

ocircumflexacute 1ED1

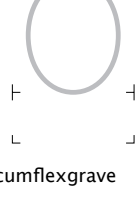

ocircumflexgrave 1ED3

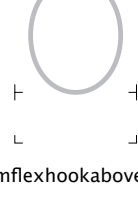

ocircumflexhookabove 1ED5

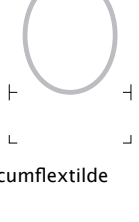

ocircumflextilde 1ED7

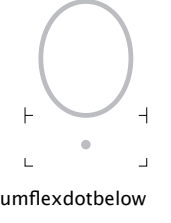

ocircumflexdotbelow 1ED9

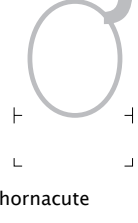

ohornacute 1EDB

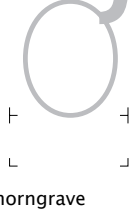

ohorngrave 1EDD

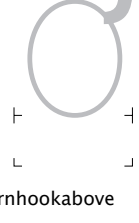

ohornhookabove 1EDF

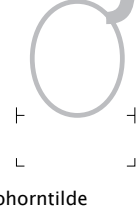

ohorntilde 1EE1

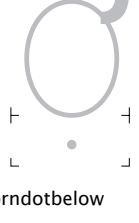

ohorndotbelow 1EE3

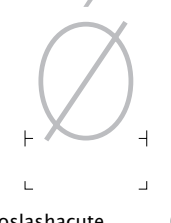

oslashacute 01FF

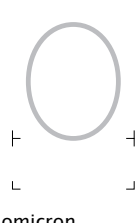

omicron 03BF

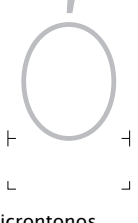

omicrontonos 03CC

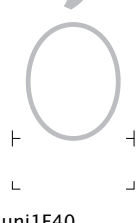

uni1F40 1F40

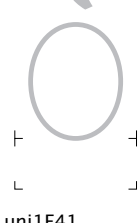



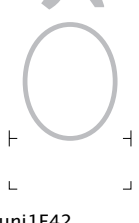















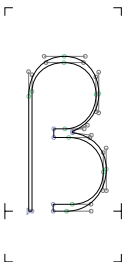
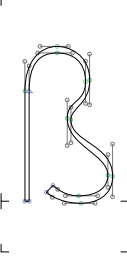
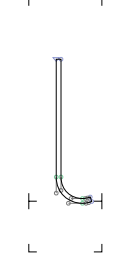
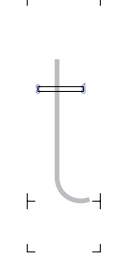

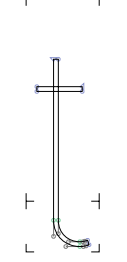
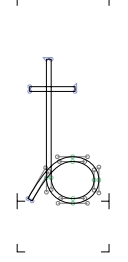
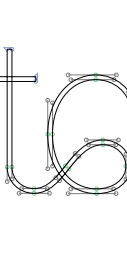
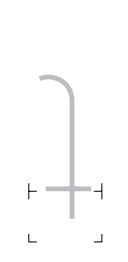
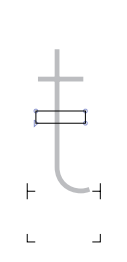
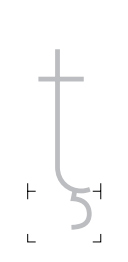

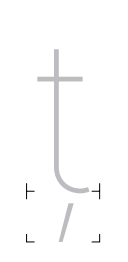
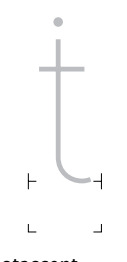
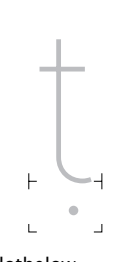
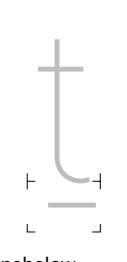
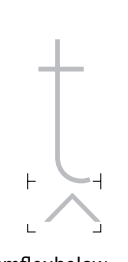
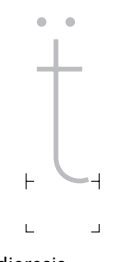
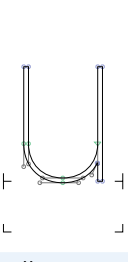
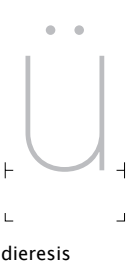

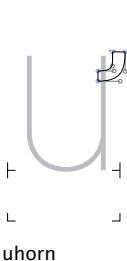
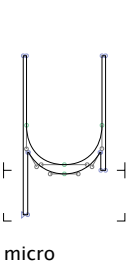
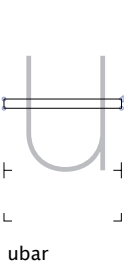
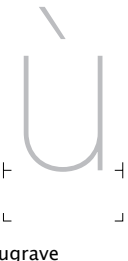
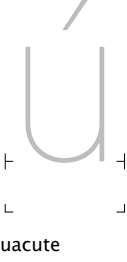

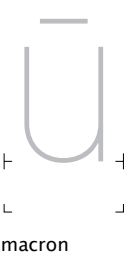
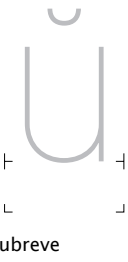
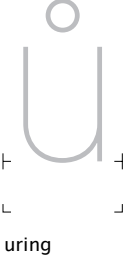
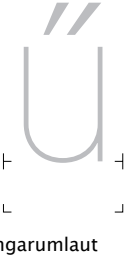
uni1F41 1F41

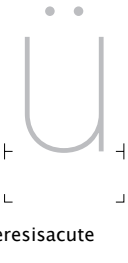

uni1F42 1F42

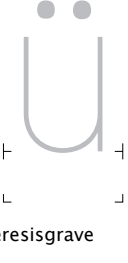
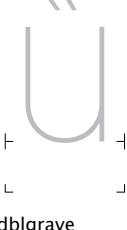
uni1F43 1F43	uni1F44 1F44	uni1F45 1F45	uni1F78 1F78	fitacyrillic 0473	obar 0275
ocyrillic 043E	odieresiscyrillic 04E7	oe 0153	ukcyrillic 0479	p 0070	uni048F 048F
phook 01A5	pacute 1E55	pdotaccent 1E57	ercyrillic 0440	q 0071	qhook 02A0
qrthook 024B	Q_rthook 024A	r 0072	rrthook	uni024D 024D	rturn 0279
rturnrthook 027B	rfishhookrev 027F	rfishhook 027E	rdescend	racute 0155	rcommaaccent 0157
rcaron 0159	rdblgrave 0211	rinvertedbreve 0213	rdotaccent 1E59	rdotbelow 1E5B	rdotbelowmacron 1E5D
rlinebelow 1E5F	r.1	rrthook.1 027D	uni024D.1	rdescend.1 027C	racute.1
rcommaaccent.1	rcaron.1	rdblgrave.1	rinvertedbreve.1	rdotaccent.1	rdotbelow.1
rdotbelowmacron.1	rlinebelow.1	s 0073	srthook 0282	uni023F 023F	sacute 015B

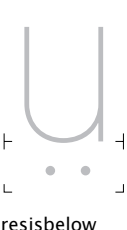
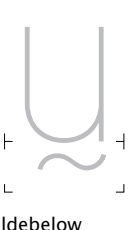
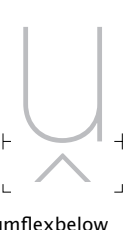
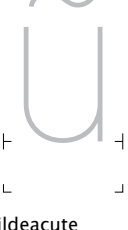
					
scircumflex 015D	scedilla 015F	scaron 0161	scommaaccent 0219	sdotaccent 1E61	sdotbelow 1E63
					
sacutedotaccent 1E65	scarondotaccent 1E67	sdotbelowdotaccent 1E69	dzecyrillic 0455	tonetwo 01A8	germandbls 00DF
					
germandbls.1	_part.t_base	t 0074	tpalatalhook 01AB	trthook 0288	tcurl 0236
					
tccurl 02A8	tturn 0287	tbar 0167	tcedilla 0163	tcaron 0165	tcommaaccent 021B
					
tdotaccent 1E6B	tdotbelow 1E6D	tlinebelow 1E6F	tcircumflexbelow 1E71	tdieresis 1E97	u 0075
					
udieresis 00FC	utilde 0169	uhorn 01B0	micro 00B5	ubar 0289	ugrave 00F9
					
uacute 00FA	ucircumflex 00FB	umacron 016B	ubreve 016D	uring 016F	uhungarumlaut 0171
					
uogonek 0173	ucaron 01D4	udieresismacron 01D6	udieresisacute 01D8	udieresiscaron 01DA	udieresisgrave 01DC
					
udblgrave 0215	uinvertedbreve 0217	udieresisbelow 1E73	utildebelow 1E75	ucircumflexbelow 1E77	utildeacute 1E79

umacrondieresis 1E7B	udotbelow 1EE5	uhookabove 1EE7	uhornacute 1EE9	uhorngrave 1EEB	uhornhookabove 1EED
uhorntilde 1EEF	uhorndotbelow 1EF1	v 0076	vturn 028C	vtilde 1E7D	vdotbelow 1E7F
w 0077	wdieresis 1E85	wturn 028D	wcircumflex 0175	wgrave 1E81	wacute 1E83
wdotaccent 1E87	wdotbelow 1E89	wring 1E98	x 0078	xdotaccent 1E8B	xdieresis 1E8D
khacyrillic 0445	chi 03C7	y 0079	ydieresis 00FF	yhook 01B4	uni024F 024F
yacute 00FD	ycircumflex 0177	uni0233 0233	ydotaccent 1E8F	yring 1E99	ygrave 1EF3
ydotbelow 1EF5	yhookabove 1EF7	ytilde 1EF9	ucyrillic 0443	ushortcyrillic 045E	umacroncyrillic 04EF
udieresiscyrillic 04F1	uhungarumlautcyrillic 04F3	yturn 028E	z 007A	zbar 01B6	zhook 0225
uni0240 0240	zrhook 0290	zacute 017A	zdotaccent 017C	zcaron 017E	zcircumflex 1E91



zdotbelow 1E93



zlinebelow 1E95

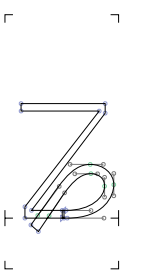

zcurl 0291

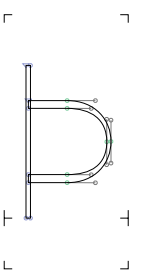

Thorn 00DE

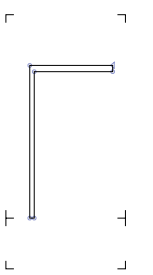

Gamma 0393

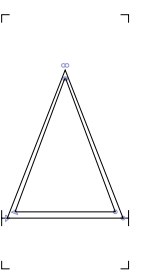

Delta 0394

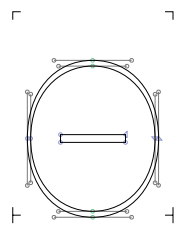

Theta 0398

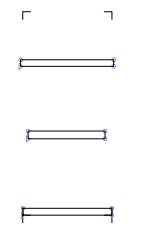

Xi 039E

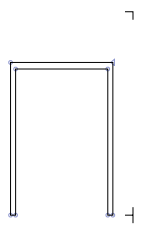

Pi 03A0

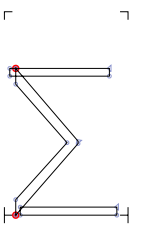

Sigma 03A3

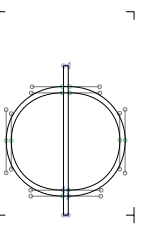

Phi 03A6

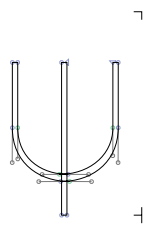

Psi 03A8

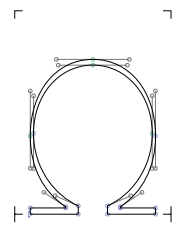

Omega 03A9



uni1FFB 1FFB



Omegatonos 038F



uni1F68 1F68



uni1F69 1F69



uni1F6A 1F6A



uni1F6B 1F6B



uni1F6C 1F6C



uni1F6D 1F6D



uni1F6E 1F6E



uni1F6F 1F6F

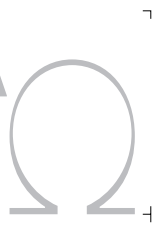

uni1FFA 1FFA



uni1FA8 1FA8



uni1FA9 1FA9



uni1FAA 1FAA



uni1FAB 1FAB



uni1FAC 1FAC



uni1FAD 1FAD



uni1FAE 1FAE

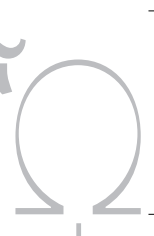

uni1FAF 1FAF

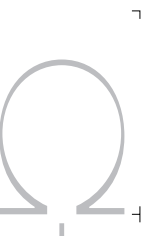

uni1FFC 1FFC

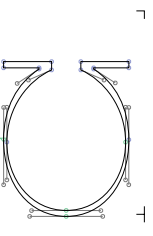

Upsilon2 01B1

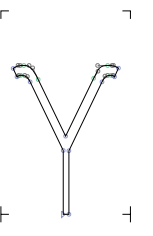

Upsilonhooksymbol 03D2



Upsilonacutehooksymbol 03D3



Upsilondieresishooksymbol 03D4

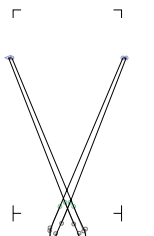

Gamma1 0194

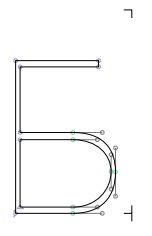

afii10018 0411

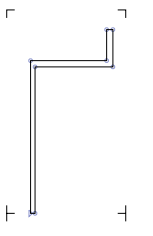

afii10050 0490



uni04FA 04FA

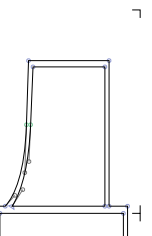

afii10021 0414

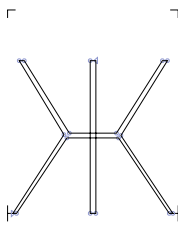

afii10024 0416



Zhedescendercyrillic 0496



afii10025 0417

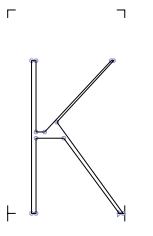

Kacyr 041A

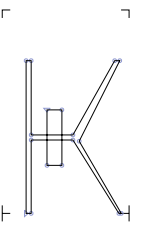

Kaverticalstrokecyrillic 049C

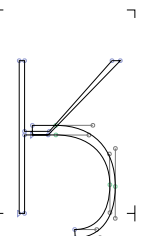

Kahookcyrillic 04C3

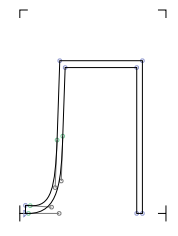

afii10029 041B

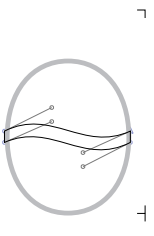

afii10147 0472

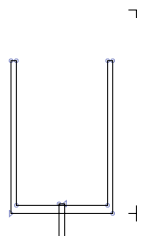

afii10145 040F

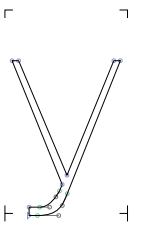

afii10037 0423

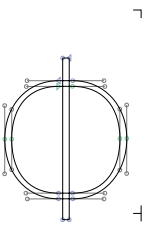

afii10038 0424

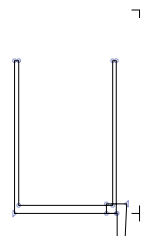

afii10040 0426

Tetsecyrillic 04B4 afii10041 0427 Chedescendercyrillic 04B6 Cheverticalstrokecyrillic 04B8 Shhacyrillic 04BA afii10060 040B

afii10042 0428 afii10043 0429 afii10044 042A afii10045 042B afii10046 042C afii10058 0409

afii10059 040A afii10047 042D afii10048 042E afii10049 042F Ghemiddlehookcyrillic 0494 Pemiddlehookcyrillic 04A6

afii10053 0404 Haabkhasiancyrillic 04A8 Cheabkhasiancyrillic 04BC Schwacyrillic 04D8 Dzeabkhasiancyrillic 04E0 afii10148 0474

afii10051 0402 eth 00F0 thorn 00FE alpha 03B1 alphonos 03AC uni1F00 1F00

uni1F01 1F01 uni1F02 1F02 uni1F03 1F03 uni1F04 1F04 uni1F05 1F05 uni1F06 1F06

uni1F07 1F07 uni1F70 1F70 uni1F80 1F80 uni1F81 1F81 uni1F82 1F82 uni1F83 1F83

uni1F84 1F84 uni1F85 1F85 uni1F86 1F86 uni1F87 1F87 uni1FB0 1FB0 uni1FB1 1FB1

uni1FB2 1FB2 uni1FB3 1FB3 uni1FB4 1FB4 uni1FB6 1FB6 uni1FB7 1FB7 beta 03B2

	gamma	03B3		delta	03B4		epsilon	03B5		epsilon-tonos	03AD		epsilon-closed	029A		epsilon1	025B
	epsilon1rev	025C		epsilon1revclosed	025E		epsilon1revhook	025D		uni1F10	1F10		uni1F11	1F11		uni1F12	1F12
	uni1F13	1F13		uni1F14	1F14		uni1F15	1F15		uni1F72	1F72		zeta	03B6		eta	03B7
	etatonos	03AE		uni1F20	1F20		uni1F21	1F21		uni1F22	1F22		uni1F23	1F23		uni1F24	1F24
	uni1F25	1F25		uni1F26	1F26		uni1F27	1F27		uni1F74	1F74		uni1F90	1F90		uni1F91	1F91
	uni1F92	1F92		uni1F93	1F93		uni1F94	1F94		uni1F95	1F95		uni1F96	1F96		uni1F97	1F97
	uni1FC2	1FC2		uni1FC3	1FC3		uni1FC4	1FC4		uni1FC6	1FC6		uni1FC7	1FC7		theta	03B8
	iota	03B9		iotadierisistonos	0390		iotatonos	03AF		iotadieresis	03CA		uni1F30	1F30		uni1F31	1F31
	uni1F32	1F32		uni1F33	1F33		uni1F34	1F34		uni1F35	1F35		uni1F36	1F36		uni1F37	1F37



uni1F76 1F76



uni1FD0 1FD0



uni1FD1 1FD1



uni1FD2 1FD2



uni1FD6 1FD6



uni1FD7 1FD7

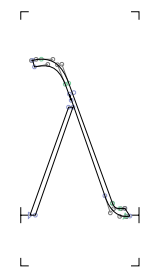

lambda 03BB

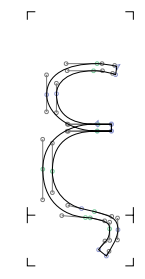

xi 03BE

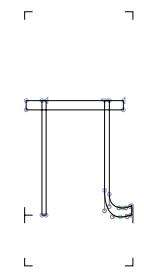

pi 03C0

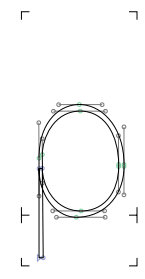

rho 03C1



uni1FE4 1FE4



uni1FE5 1FE5

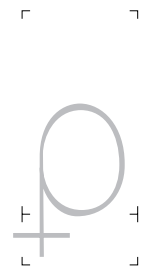

uni03FC 03FC

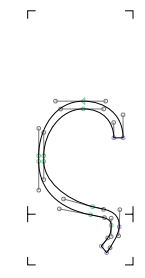

sigma1 03C2

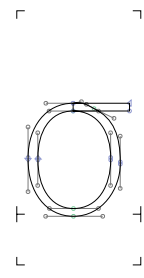

sigma 03C3

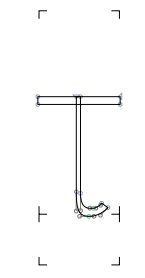

tau 03C4

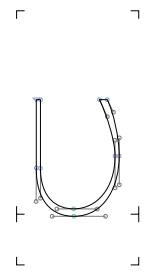

upsilon 03C5

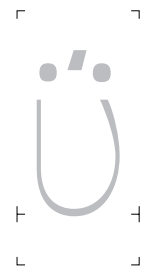

upsilondieresistonos 03B0



upsilondieresis 03CB



upsilontonos 03CD



uni1F50 1F50



uni1F51 1F51

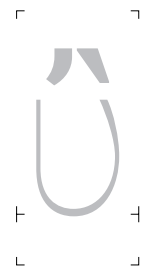

uni1F52 1F52



uni1F53 1F53



uni1F54 1F54



uni1F55 1F55



uni1F56 1F56



uni1F57 1F57

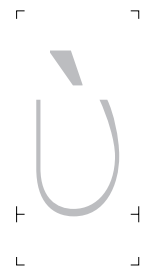

uni1F7A 1F7A



uni1FE0 1FE0



uni1FE1 1FE1

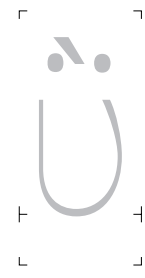

uni1FE2 1FE2



uni1FE6 1FE6

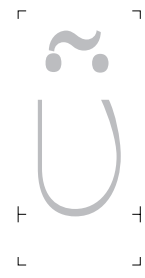

uni1FE7 1FE7

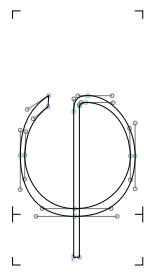

phi 03C6

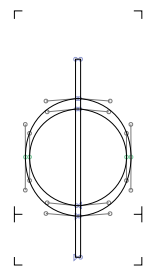

phigreek 03D5

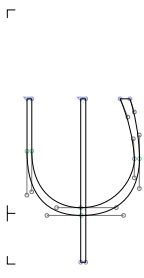

psi 03C8

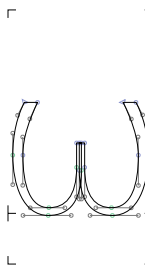

omega 03C9



omegatonos 03CE



uni1F60 1F60



uni1F61 1F61



uni1F62 1F62



uni1F63 1F63



uni1F64 1F64



uni1F65 1F65



uni1F66 1F66



uni1F67 1F67



uni1F7C 1F7C



uni1FA0 1FA0



uni1FA1 1FA1



uni1FA2 1FA2



uni1FA3 1FA3



uni1FA4 1FA4



uni1FA5 1FA5



uni1FA6 1FA6



uni1FA7 1FA7

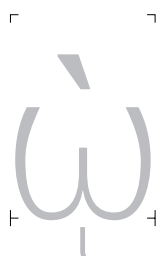

uni1FF2 1FF2



uni1FF3 1FF3



uni1FF4 1FF4



uni1FF6 1FF6

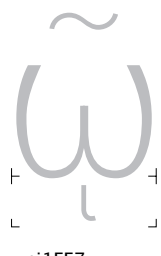

uni1FF7 1FF7

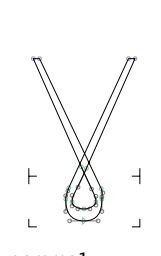

gamma1 0263

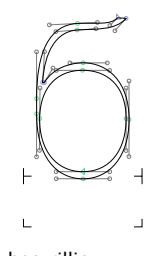

becyrillic 0431

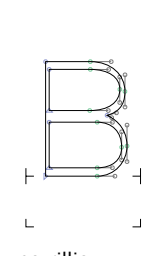

vecyrillic 0432

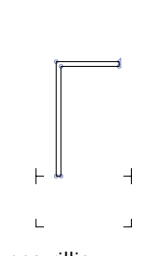

gecyrillic 0433

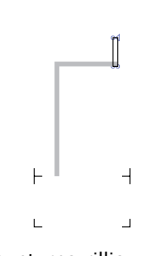

gheupturncyrillic 0491

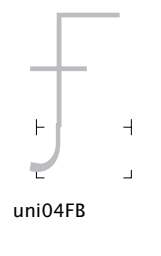

uni04FB 04FB

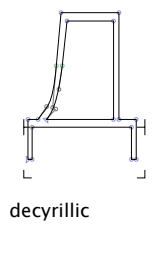

decyrillic 0434

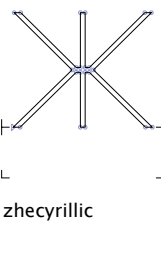

zhecyrillic 0436

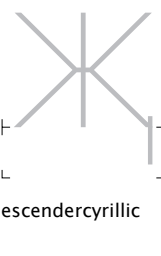

zhedescendercyrillic 0497

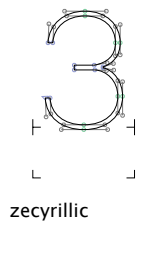

zecyrillic 0437

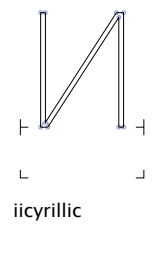

iicyrillic 0438



uni048B 048B

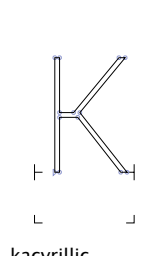

kacyrillic 043A

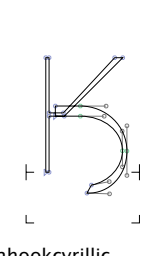

kahookcyrillic 04C4

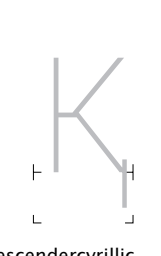

kadescendercyrillic 049B

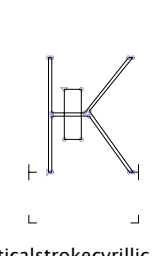

kaverticastrokescyrillic 049D

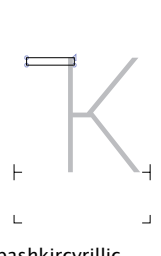

kabashkircyrillic 04A1

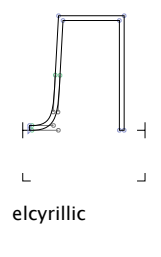

elcyrillic 043B



uni04C6 04C6



uni052F 052F

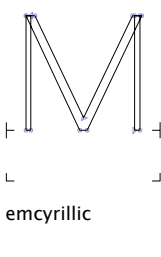

emcyrillic 043C



uni04CE 04CE

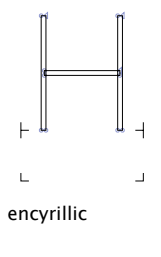

encyrillic 043D

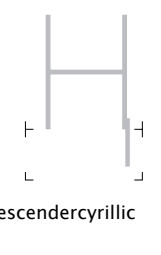

endescendercyrillic 04A3

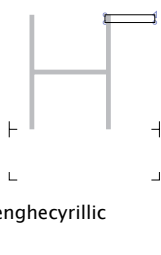

enghecyrillic 04A5

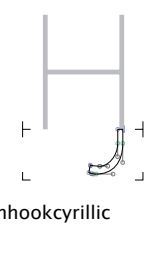

enhookcyrillic 04C8

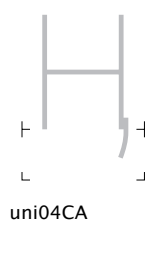

uni04CA 04CA

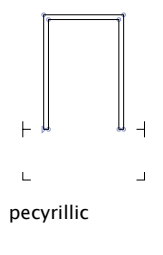

pecyrillic 043F

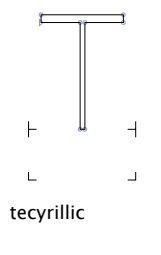

tecyrillic 0442

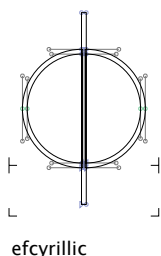

efcyrillic 0444

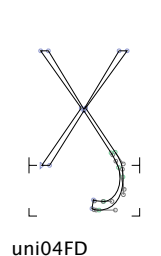

uni04FD 04FD

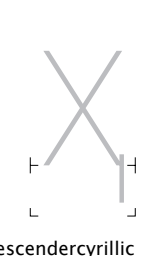

hadescendercyrillic 04B3

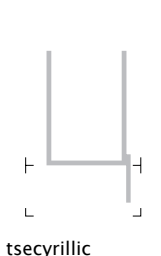

tsecyrillic 0446

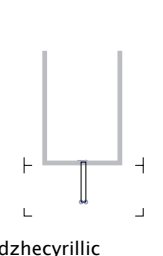

dzhecyrillic 045F

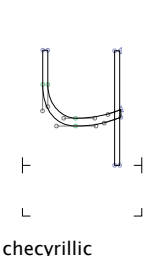

checyrillic 0447

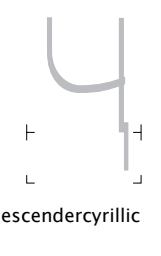

chedescendercyrillic 04B7

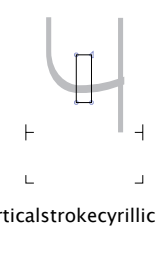

cheverticalstrokecyrillic 04B9

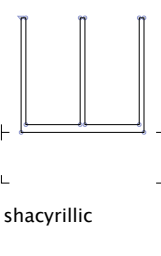

shacyrillic 0448

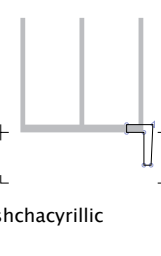

shhacyrillic 0449

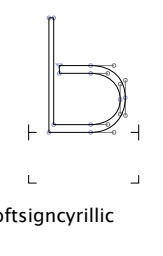

softsigncyrillic 044C

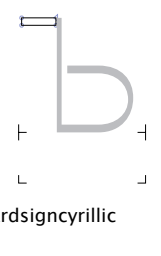

hardsigncyrillic 044A



yericyrillic 044B

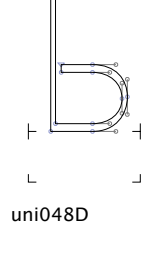

uni048D 048D

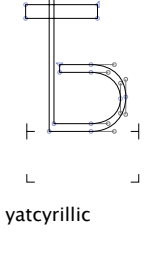

yatcyrillic 0463



ljecyrillic 0459

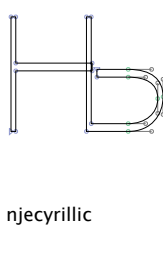

njecyrillic 045A

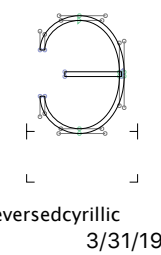

ereversedcyrillic 044D

iucyrillic 044E	iacyrillic 044F	ghemiddlehookcyrillic 0495	pemiddlehookcyrillic 04A7	ecyrillic 0454	haabkhasiancyrillic 04A9

tetsecyrillic 04B5	cheabkhasiancyrillic 04BD	dzeabkhasiancyrillic 04E1	izhitsacyrillic 0475	dollar 0024	cent 00A2

yen 00A5	sterling 00A3	florin 0192	uni20BA 20BA	uni20BD 20BD	euro 20AC

uni20B9 20B9	tenge 20B8	peseta 20A7	peso 20B1	kip 20AD	won 20A9

lira 20A4	austral 20B3	hryvnia 20B4	naira 20A6	guarani 20B2	coloncurrency 20A1

cedi 20B5	cruzeiro 20A2	tugrik 20AE	uni20AF 20AF	mill 20A5	afi57636 20AA

manat 20BC	rupee 20A8	lari 20BE	franc 20A3	zero 0030	one 0031

two 0032	twostroke 01BB	three 0033	four 0034	five 0035	Tonefive 01BC

six 0036	seven 0037	eight 0038	nine 0039	zero.slash	one.ss01

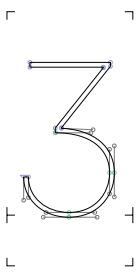

three.1

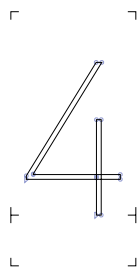

four.ss01

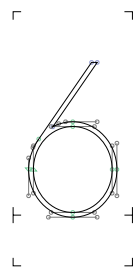

six.ss01

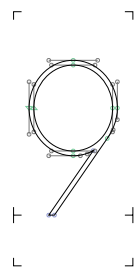

nine.ss01

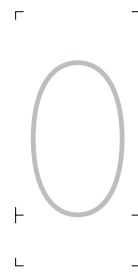

zero.tf



one.tf



two.tf



three.tf



four.tf



five.tf



six.tf



seven.tf

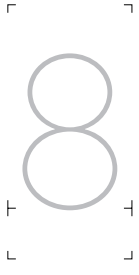

eight.tf

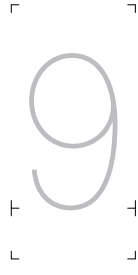

nine.tf

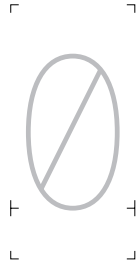

zero.tf.slash

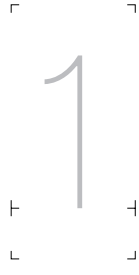

one.tf.ss01



three.1.tf



four.tf.ss01



six.tf.ss01



nine.tf.ss01

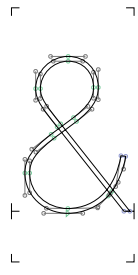

ampersand 0026

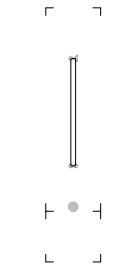

exclam 0021



exclamdbl 203C



exclamdown 00A1



uni2049 2049

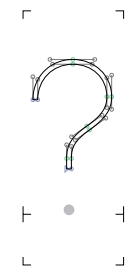

question 003F



uni2047 2047



uni2048 2048



questiondown 00BF

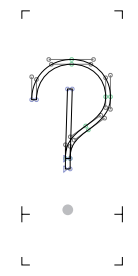

interrobang 203D



invertedinterrobang 2E18

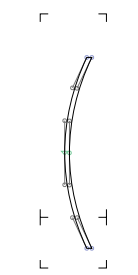

parenleft 0028



parenright 0029

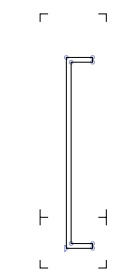

bracketleft 005B

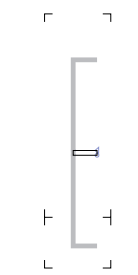

bracketleft_quill 2045

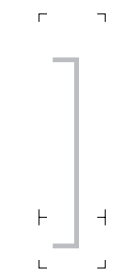

bracketright 005D



bracketright_quill 2046

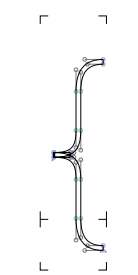

braceleft 007B



braceright 007D

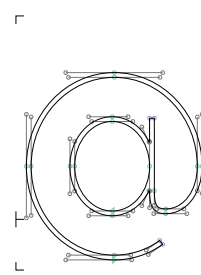

at 0040



parenleft.case



parenright.case



bracketleft.case



bracketright.case

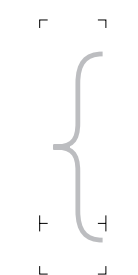

braceleft.case

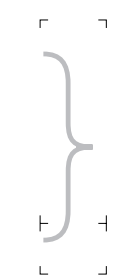

braceright.case



at.case

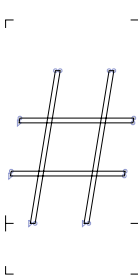

numbersign 0023

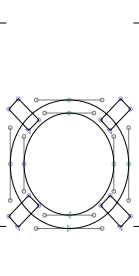

currency 00A4

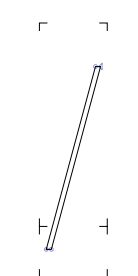

slash 002F

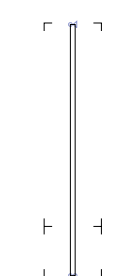

bar 007C

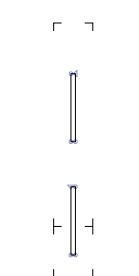

brokenbar 00A6



backslash 005C

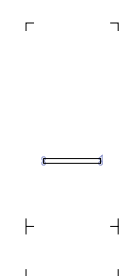

hyphen 002D

softhyphen 00AD	endash 2013	figuredash 2012	emdash 2014	horizontalbar 2015	bullet 2022
openbullet 25E6	hyphenbullet 2043	trianglebullet 2023	blackleftbullet 204C	blackrightbullet 204D	hyphen.case
endash.case	figuredash.case	emdash.case	bullet.case	openbullet.case	hyphenbullet.case
trianglebullet.case	blackleftbullet.case	blackrightbullet.case	quoteleft 2018	quoteright 2019	apostrophemod 02BC
quotesingle 0027	quotedbl 0022	quotedblleft 201C	quotedblright 201D	quotedblbase 201E	quotesinglbase 201A
prime 2032	doubleprime 2033	tripleprime 2034	quadrupleprime 2057	primerev 2035	doubleprimerev 2036
tripleprimerev 2037	primemod 02B9	doubleprimemod 02BA	comma 002C	period 002E	ellipsis 2026
twodotleader 2025	colon 003A	colon.case	semicolon 003B	comma.tf	period.tf
colon.tf	semicolon.tf	periodcentered 00B7	anoteleia 0387	questiongreek 037E	guilsingleft 2039

					
guilsinglright 203A	guillemetleft 00AB	guillemetright 00BB	less 003C	greater 003E	lessequal 2264
					
greaterequal 2265	equal 003D	notequal 2260	plus 002B	minus 2212	multiply 00D7
					
divide 00F7	plusminus 00B1	approxequal 2248	asciitilde 007E	less.case	greater.case
					
lessequal.case	greaterequal.case	equal.case	notequal.case	plus.case	minus.case
					
multiply.case	divide.case	plusminus.case	approxequal.case	asciitilde.case	logicalnot 00AC
					
underscore 005F	dagger 2020	daggerdbl 2021	asciicircum 005E	asterisk 002A	asterisk.case
					
registered 00AE	trademark 2122	servicemark 2120	tel 2121	uni213B 213B	uni1F16B 1F16B
					
uni1F16A 1F16A	degree 00B0	ordfeminine 00AA	ordmasculine 00BA	i.numr	n.numr
					
paragraph 00B6	paragraphreversed 204B	section 00A7	copyright 00A9	infinity 221E	partialdiff 2202

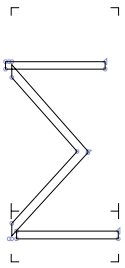

summation 2211

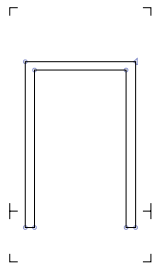

product 220F

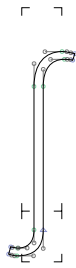

integral 222B

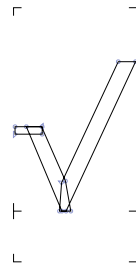

radical 221A

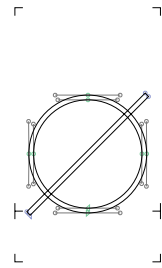

emptyset 2205

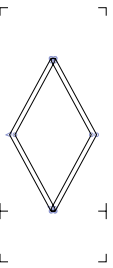

lozenge 25CA

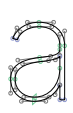

a.sups 1D43

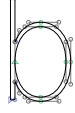

b.sups 1D47

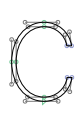

c.sups 1D9C

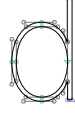

d.sups 1D48

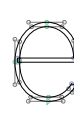

e.sups 1D49

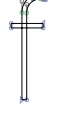

f.sups 1DA0

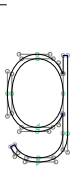

g.sups 1D4D

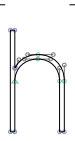

h.sups 02B0

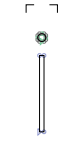

i.sups 2071

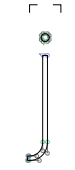

j.sups 02B2

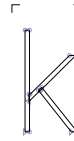

k.sups 1D4F

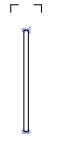

l.sups 02E1

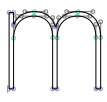

m.sups 1D50

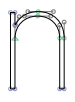

n.sups 207F

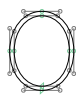

o.sups 1D52

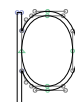

p.sups 1D56

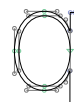

q.sups 146B



r.sups 02B3

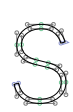

s.sups 02E2

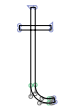

t.sups 1D57

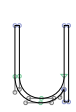

u.sups 1D58

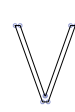

v.sups 1D5B

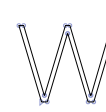

w.sups 02B7

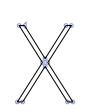

x.sups 02E3



y.sups 02B8



z.sups 1D8B



zero.sups 2070



one.sups 00B9



two.sups 00B2



three.sups 00B3

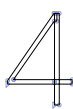

four.sups 2074

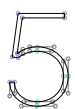

five.sups 2075

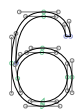

six.sups 2076

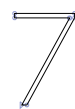

seven.sups 2077

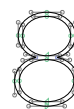

eight.sups 2078

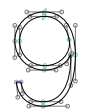

nine.sups 2079



parenleft.sups 207D



parenright.sups 207E



bracketleft.sups

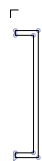

bracketright.sups



plus.sups 207A



minus.sups 207B



equal.sups 207C



a.subs 2090



b.subs



c.subs



d.subs



e.subs 2091

f.subs

g.subs

h.subs 2095

i.subs 1D62

j.subs 2C7C

k.subs 2096

l.subs 2097

m.subs 2098

n.subs 2099

o.subs 2092

p.subs 209A

q.subs

r.subs 1D63

s.subs 209B

t.subs 209C

u.subs 1D64

v.subs 1D65

w.subs

x.subs 2093

y.subs

z.subs

zero.subs 2080

one.subs 2081

two.subs 2082

three.subs 2083

four.subs 2084

five.subs 2085

six.subs 2086

seven.subs 2087

eight.subs 2088

nine.subs 2089

parenleft.subs 208D

parenright.subs 208E

bracketleft.subs

bracketright.subs

plus.subs 208A

minus.subs 208B

equal.subs 208C

zero.dnomf

one.dnomf

two.dnomf

three.dnomf

four.dnomf

five.dnomf

six.dnomf

seven.dnomf

eight.dnomf

nine.dnomf

fraction 2044

zero.dnom

one.dnom

two.dnom

three.dnom

four.dnom

5

five.dnom

6

six.dnom

7

seven.dnom

8

eight.dnom

9

nine.dnom

+

plus.dnom

-

minus.dnom

=

equal.dnom

(

parenleft.dnom

)

parenright.dnom

0

zero.numr

1

one.numr

2

two.numr

3

three.numr

4

four.numr

5

five.numr

6

six.numr

7

seven.numr

8

eight.numr

9

nine.numr

+

plus.numr

-

minus.numr

=

equal.numr

(

parenleft.numr

)

parenright.numr

0

zero.frac

1

one.frac

2

two.frac

3

three.frac

4

four.frac

5

five.frac

6

six.frac

7

seven.frac

8

eight.frac

9

nine.frac

1/2

onehalf 00BD

1/3

onethird 2153

1/4

onequarter 00BC

3/4

threequarters 00BE

5/6

fivesixths 215A

1/8

onefraction 215F

7/8

seveneighths 215E

1/8

oneeighth 215B

5/8

fiveeighths 215D

3/8

threeeighths 215C

%

percent 0025

‰

perthousand 2030

‱

pertenthousand 2031

A/s

uni214D 214D

c/u

cadauna 2106

c/o

careof 2105

a/c











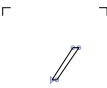
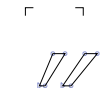
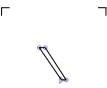



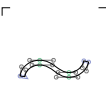

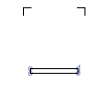

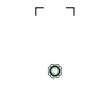
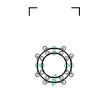
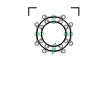
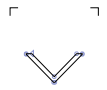
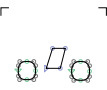









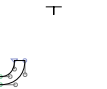
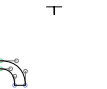
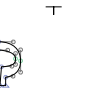

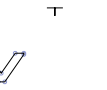

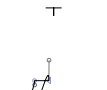

accountof 2100

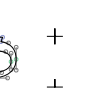
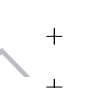
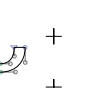
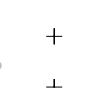
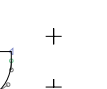
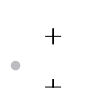
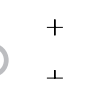
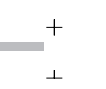
a/s

addresssubject 2101

Nº

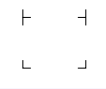
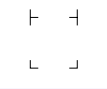
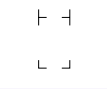
numero 2116

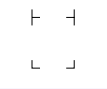
					
acute 00B4	hungarumlaut 02DD	grave 0060	tonos 0384	dieresis 00A8	casedieresis.cn
					
circumflex 02C6	tilde 02DC	casetilde.cn	macron 00AF	breve 02D8	cyrillicbreve
					
dotaccent 02D9	ring 02DA	ring.uc	caron 02C7	dieresis-tonos 0385	cedilla 00B8
					
ogonek 02DB	commaaccent F6C3	acutecomb 0301	acutedblnosp 030B	gravecomb 0300	dblgravecmb 030F
					
macroncomb 0304	dieresisnosp 0308	brevenosp 0306	breveinvnosp 0311	hook 0309	circumflexnosp 0302
					
caroncmb 030C	tildecomb 0303	dotnosp 0307	ringnosp 030A	hornnosp 031B	ogoneknosp 0328
					
cedillanosp 0327	circumflexsubnosp 032D	brevesubnosp 032E	dotbelow 0323	commabelowcmb 0326	dotdblsubnosp 0324
					
ringsubnosp 0325	underscorenosp 0332	tildesubnosp 0330	enquad 2000	emquad 2001	enspace 2002
					
emspace 2003	thirdemspace 2004	quarteremspace 2005	sixthemspace 2006	figurespace 2007	punctuationspace 2008

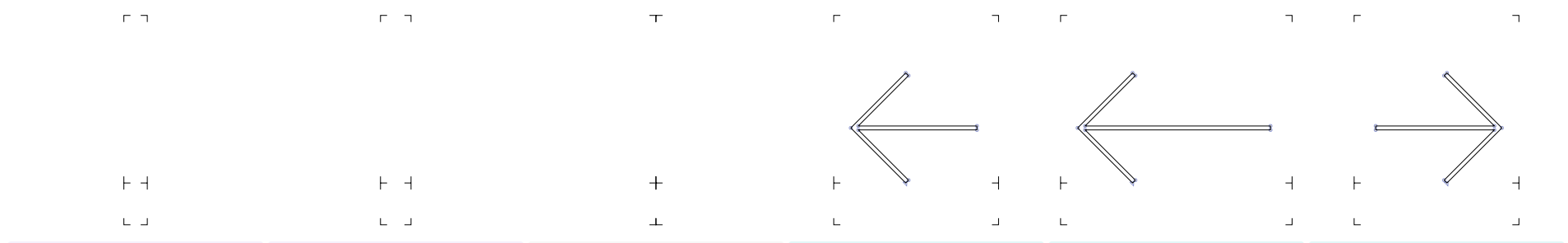

thinspace 2009 hairspace 200A zerowidthspace 200B leftArrow 2190 leftLongArrow 27F5 rightArrow 2192

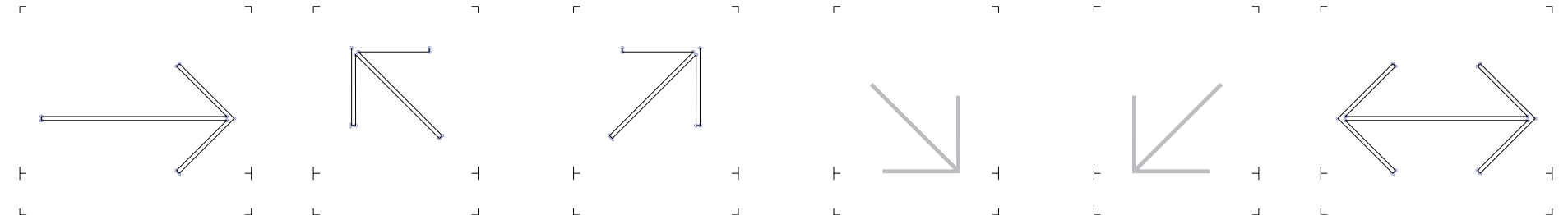

rightLongArrow 27F6 northWestArrow 2196 northEastArrow 2197 southEastArrow 2198 southWestArrow 2199 leftRightArrow 2194

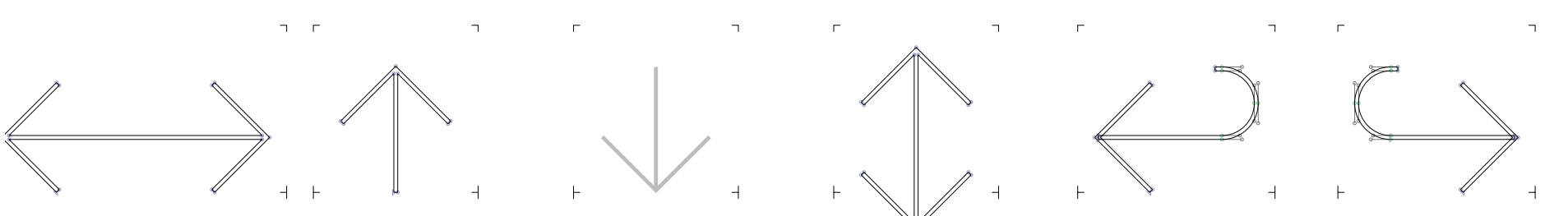

leftRightLongArrow 27F7 upArrow 2191 downArrow 2193 upDownArrow 2195 leftHookArrow 21A9 rightHookArrow 21AA

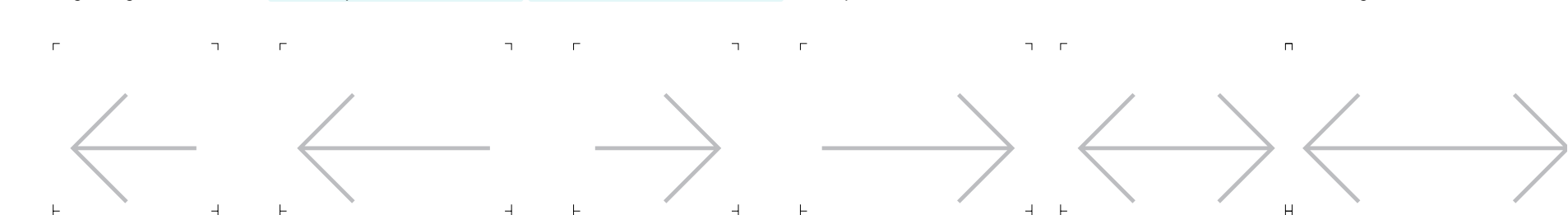

leftArrow.case leftLongArrow.case rightArrow.case rightLongArrow.case leftRightArrow.case leftRightLongArrow.case

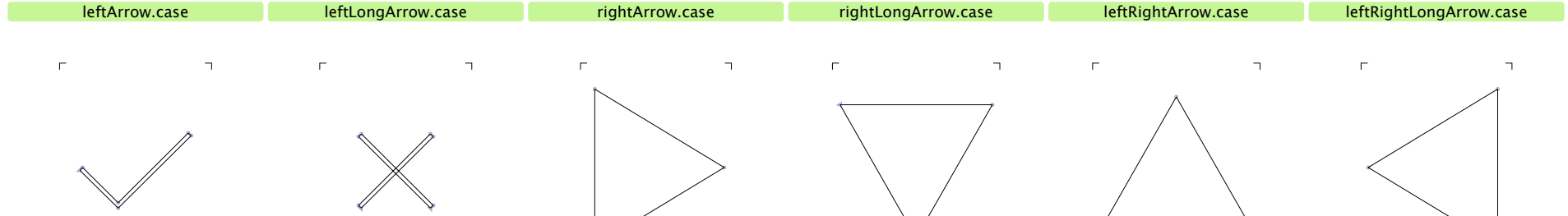

dngb_check 2713 dngb_ballotx 2717 triagrt 25BA triagdn 25BC triagup 25B2 blackleftpointingtriangle 25C0

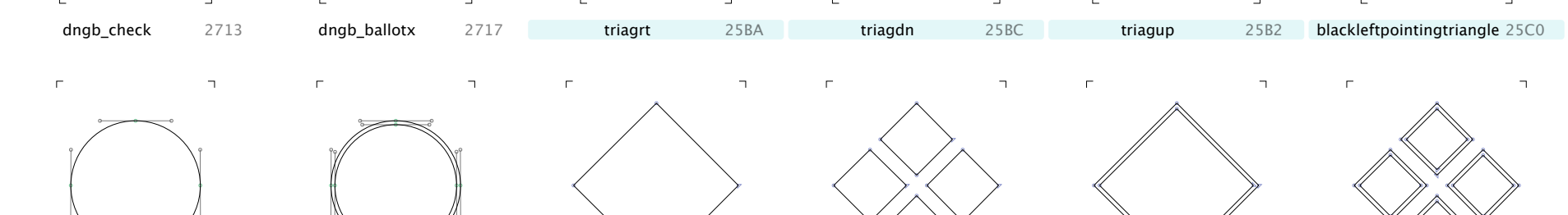

circleblack 25CF circlewhite 25CB diamondblack 25C6 diamondblack_x 2756 diamondwhite 25C7 diamondwhite_x E000

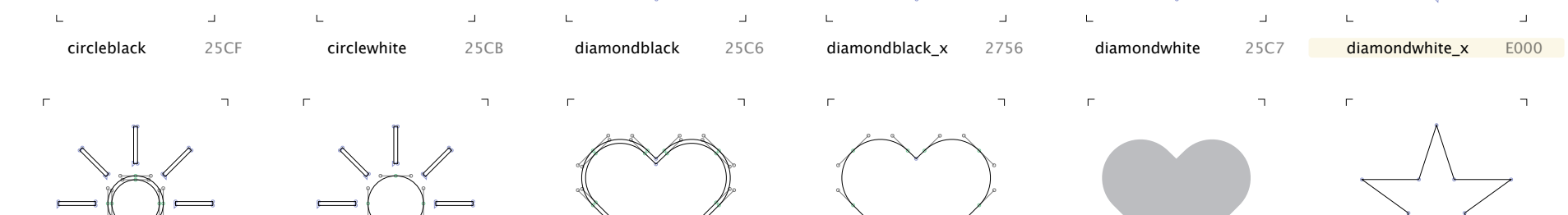



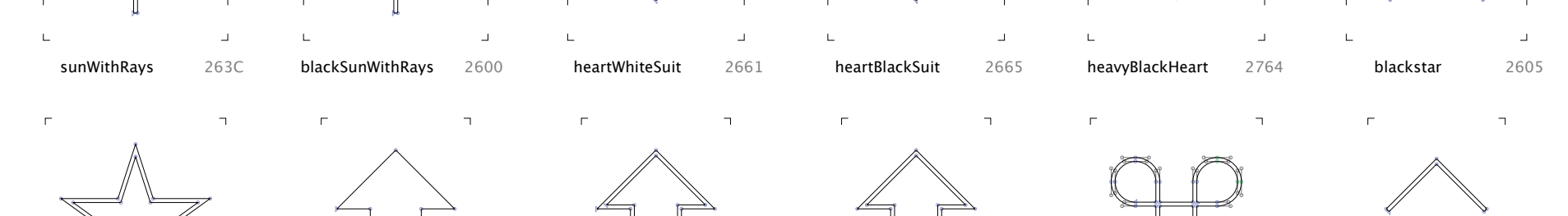



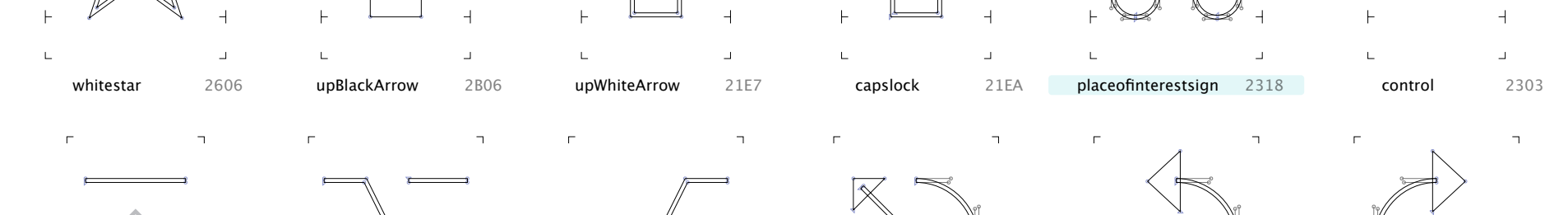



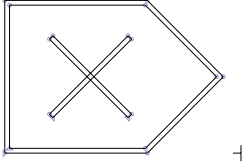
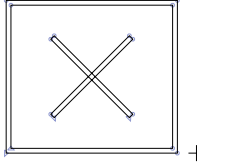
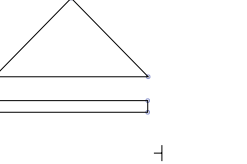
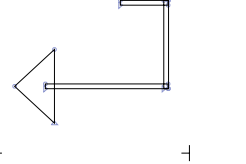
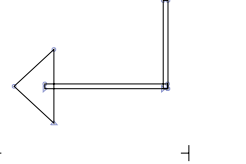
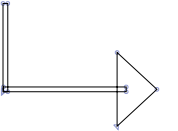
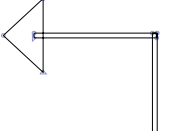
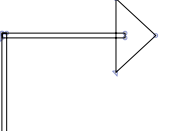
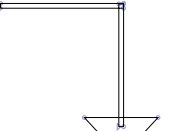
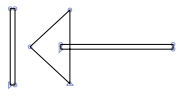
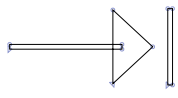
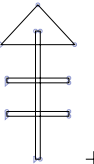
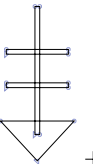
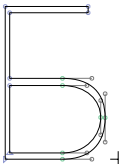

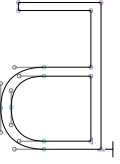
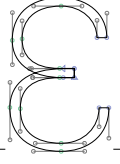

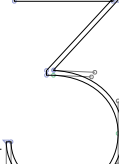

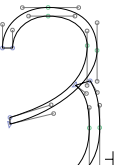

sunWithRays 263C blackSunWithRays 2600 heartWhiteSuit 2661 heartBlackSuit 2665 heavyBlackHeart 2764 blackstar 2605

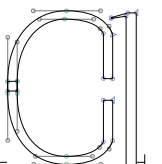
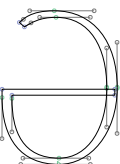

whitestar 2606 upBlackArrow 2B06 upWhiteArrow 21E7 capslock 21EA placeofinterestsign 2318 control 2303

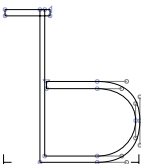
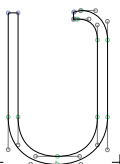
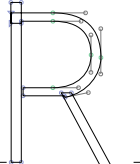
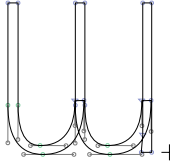
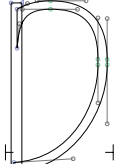
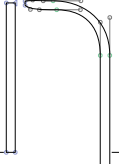
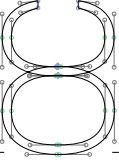
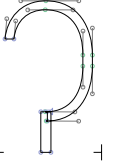
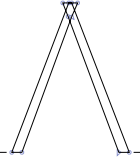

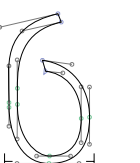
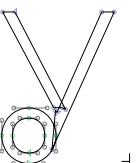
projective 2305 option 2325 alternativekeysymbol 2387 brokenCircleNorthWestAr 238B anticlockwiseOpenCircleA 21BA clockwiseOpenCircleArro 21BB

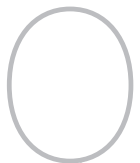
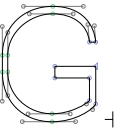
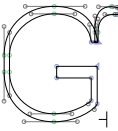
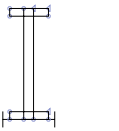
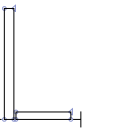
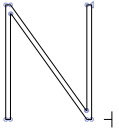
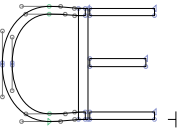
					
deleteleft 232B	deleteright 2326	clear 2327	ejectsymbol 23CF	returnsymbol 23CE	carriagereturn 21B5
					
downTipRightArrow 21B3	upTipLeftArrow 21B0	upTipRightArrow 21B1	rightCornerDownArrow 21B4	arrowtableft 21E4	arrowtabright 21E5
					
pageup 21DE	pagedown 21DF	Btopbar 0182	DZ 01F1	Eth 00D0	Dcroat 0110
					
Dtopbar 018B	Epsilon1 0190	Esh 01A9	Ezh 01B7	Ezhcaron 01EE	Ezhreversed 01B8
					
uni021C 021C	IJ 0132	lota1 0196	LJ 01C7	Ldot 013F	NJ 01CA
					
OI 01A2	Schwa 018F	Tbar 0166	Tonesix 0184	Vcursive 01B2	YR 01A6
					
mcapturn 019C	uni01F7 01F7	uni0220 0220	uni0222 0222	uni0241 0241	uni0245 0245
					
uni1EFA 1EFA	uni1EFC 1EFC	uni1EFE 1EFE	Aogonek.NAV	Eogonek.NAV	Oogonek.NAV
					
Gsmallcap 0262	Gsmallcaphook 029B	Ismallcap 026A	Lsmallcap 029F	Nsmallcap 0274	OEmallcap 0276



uni1EFB 1EFB uni1EFD 1EFD uni1EFF 1EFF uni2184 2184 upsilonlatin 028A vscript 028B

wynn 01BF aogonek.NAV eogonek.NAV oogonek.NAV uni0268.ccmp Rturnsuper 02B6

exclam1 01C3 hhooksuper 02B1 pipe 01C0 pipedbl 01C1 pipedblbar 01C2 rturnsuper 02B4

uni2094 2094 uniA7FF A7FF uni2071.ccmp uni02B2.ccmp glottalstopreversed.numr 02E4 afii10020 0413

afii10052 0403 afii10061 040C afii10033 041F afii10034 0420 afii10035 0421 afii10036 0422

afii10062 040E afii10039 0425 Omegacyrillic 0460 afii10146 0462 Eiotifiedcyrillic 0464 Yuslitlecyrillic 0466

Yuslitleiotifiedcyrillic 0468 Yusbigcyrillic 046A Yusbigiotifiedcyrillic 046C Kscyrillic 046E Psicyrillic 0470 Izhitsadblgravecyrillic 0476

Ukcyrillic 0478 Ghestrokecyrillic 0492 Zedescendercyrillic 0498 Edescendercyrillic 04AA Tedescendercyrillic 04AC Ustraightcyrillic 04AE

Ustraightstrokecyrillic 04B0 Chedescenderabkhasianc 04BE palochkacyrillic 04C0 Zhebrevecyrillic 04C1 Eltail-cy 04C5 Chekhakassiancyrillic 04CB



Schwadierescyrlilic 04DA

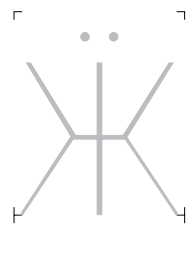

Zhedierescyrlilic 04DC



Zedierescyrlilic 04DE



uni04EC 04EC



Umacroncyrlilic 04EE



Udierescyrlilic 04F0



Uhungarumlautcyrlilic 04F2



Chedierescyrlilic 04F4

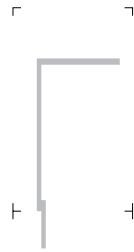

uni04F6 04F6



Yerudierescyrlilic 04F8



uni04FE 04FE

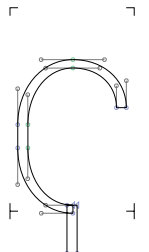

Koppacyrlilic 0480



uni048C 048C



gjecyrlilic 0453



iishortcyrlilic 0439



uni045D 045D



kjecyrlilic 045C

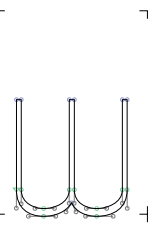

omegacyrlilic 0461

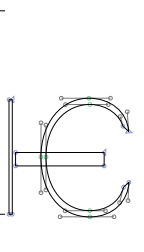

eiotifiedcyrlilic 0465

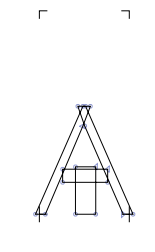

yuslitlecyrlilic 0467

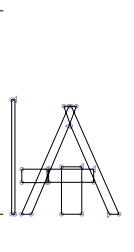

yuslitleiotifiedcyrlilic 0469

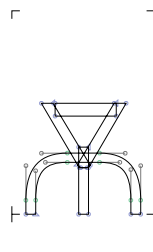

yusbigcyrlilic 046B

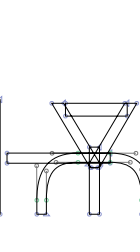

yusbigiotifiedcyrlilic 046D

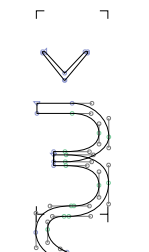

ksicyrlilic 046F



psicyrlilic 0471



izhitsadblgravecyrlilic 0477



ghestrokecyrlilic 0493



zedescendercyrlilic 0499



esdescendercyrlilic 04AB



tedescendercyrlilic 04AD



ustraightcyrlilic 04AF



ustraightstrokecyrlilic 04B1



chedescenderabkhasiancy04BF

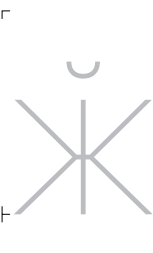

zhebrevcyrlilic 04C2



chekhakassiancyrlilic 04CC



schwacyrlilic 04D9



schwadierescyrlilic 04DB

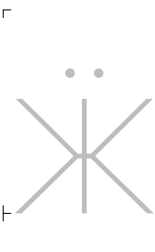

zhedierescyrlilic 04DD



zedierescyrlilic 04DF



imacroncyrlilic 04E3



idierescyrlilic 04E5

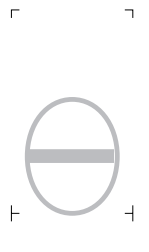

obarredcyrlilic 04E9



obarreddierescyrlilic 04EB



uni04ED 04ED



chedierescyrlilic 04F5



uni04F7 04F7



yerudierescyrlilic 04F9



uni04FF 04FF

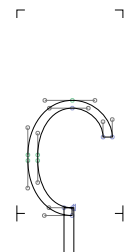

koppacyrlilic 0481

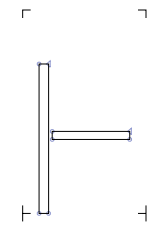

uni0370 0370

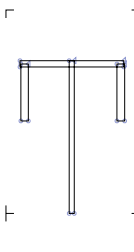

uni0372 0372

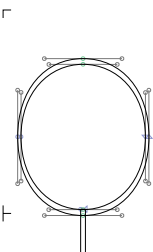



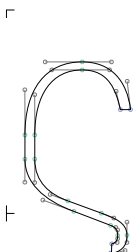

uni03D8 03D8

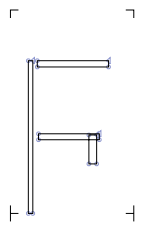

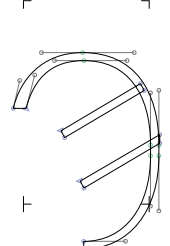
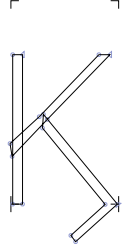

Stigma 03DA

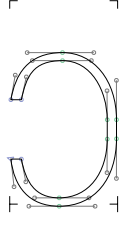

Digamma 03DC



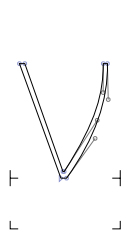
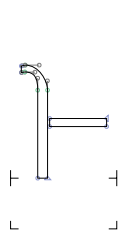
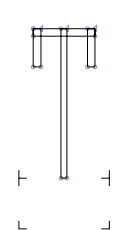

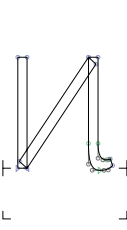
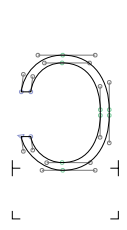
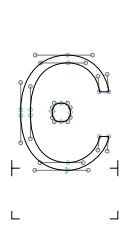
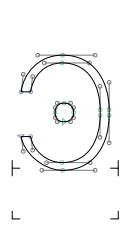
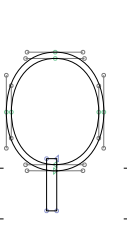
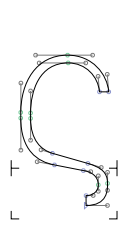
 **Koppa** 03DE  **Sampi** 03E0  **uni03CF** 03CF  **uni03F7** 03F7  **uni03FD** 03FD  **uni03FE** 03FE

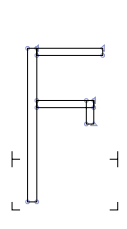
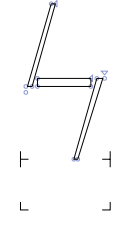
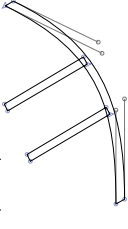
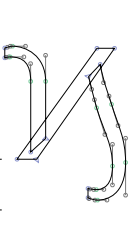
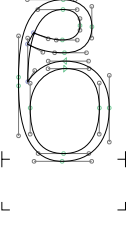
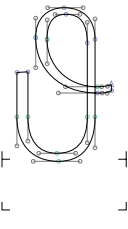

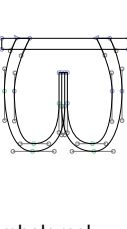
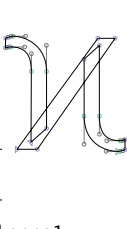
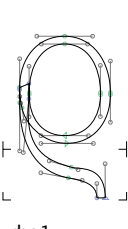
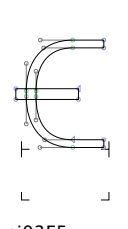
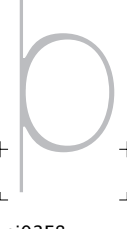
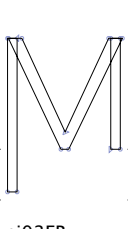

 **uni03FF** 03FF  **kappa** 03BA  **mugreek** 03BC  **nu** 03BD  **uni0371** 0371  **uni0373** 0373

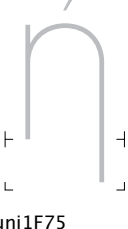

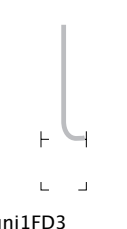
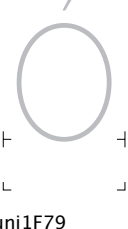
 **uni0377** 0377  **uni037B** 037B  **uni037C** 037C  **uni037D** 037D  **uni03D9** 03D9  **stigma** 03DB

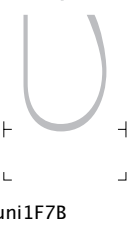
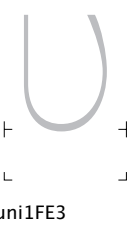

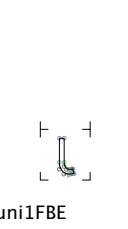

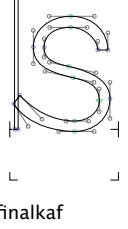
 **digamma** 03DD  **koppa** 03DF  **sampi** 03E1  **uni03D7** 03D7  **beta1** 03D0  **thetasymbolgreek** 03D1

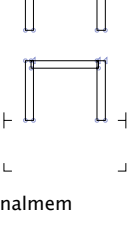
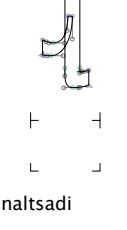
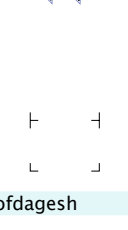
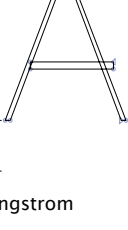
 **pisymbolgreek** 03D6  **kappa1** 03F0  **rho1** 03F1  **uni03F5** 03F5  **uni03F8** 03F8  **uni03FB** 03FB

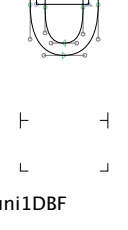
 **uni1F71** 1F71  **uni1F73** 1F73  **uni1F75** 1F75  **uni1F77** 1F77  **uni1FD3** 1FD3  **uni1F79** 1F79

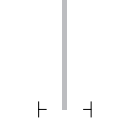
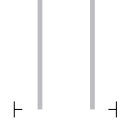
 **uni1F7B** 1F7B  **uni1FE3** 1FE3  **uni1F7D** 1F7D  **uni1FBE** 1FBE  **ypogegrammeni** 037A  **finalkaf** 02AA

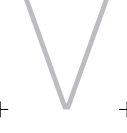
 **finalmem** 02AD  **finaltsadi** 02B5  **qofdagesh** 02DF  **angstrom** 212B  **degreekelvin** 212A  **uni1DBF** 1DBF

 **romanone** 2160  **romantwo** 2161  **romanthree** 2162  **romanfour** 2163  **romanfive** 2164  **romansix** 2165

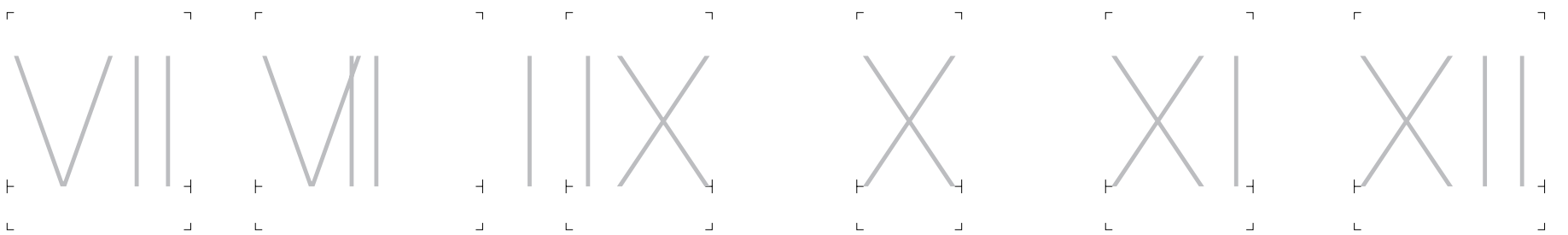

romanseven 2166 romaneight 2167 romannine 2168 romanten 2169 romaneleven 216A romantwelve 216B

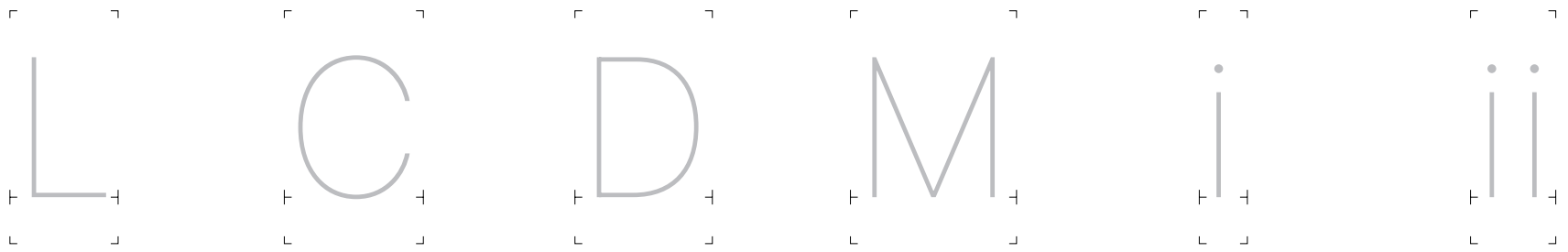

romanfifty 216C romanhundred 216D romanfivehundred 216E romanthousand 216F oneroman 2170 tworoman 2171

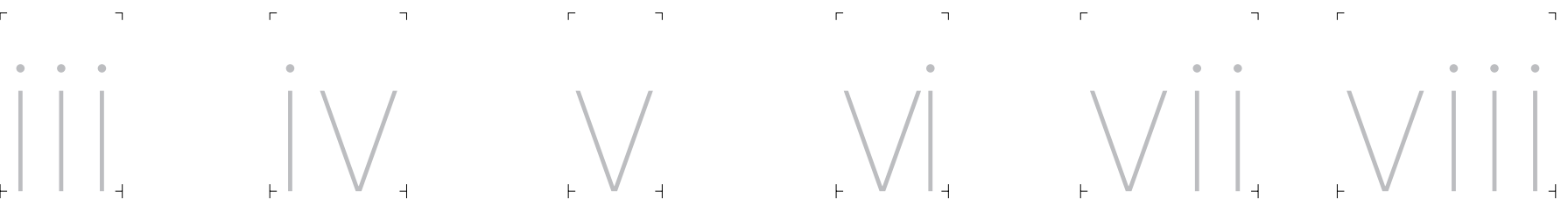

threeroman 2172 fourroman 2173 fiveroman 2174 sixroman 2175 sevenroman 2176 eightroman 2177

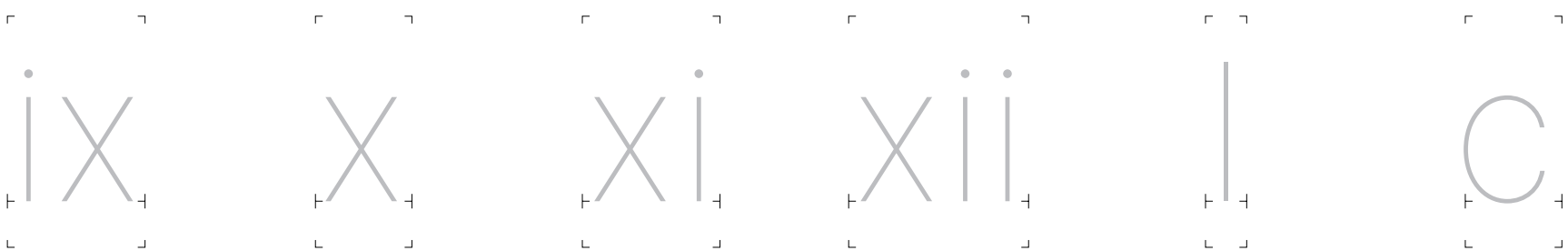

nineroman 2178 tenroman 2179 elevenroman 217A twelveroman 217B uni217C 217C uni217D 217D

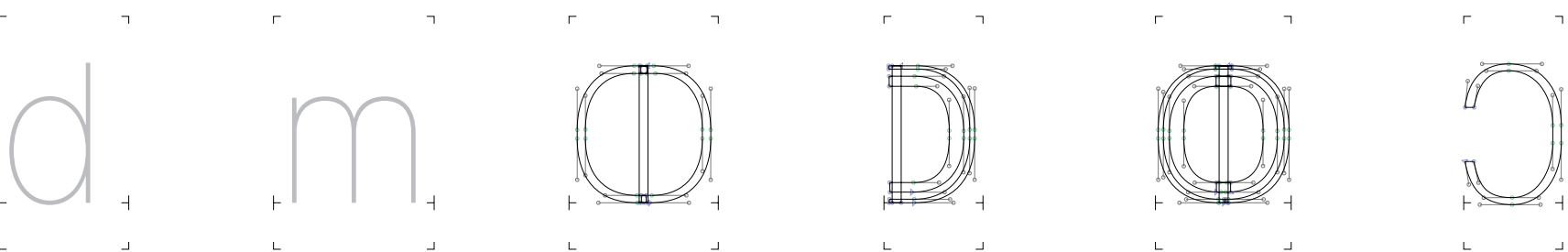

uni217E 217E uni217F 217F uni2180 2180 uni2181 2181 uni2182 2182 uni2183 2183

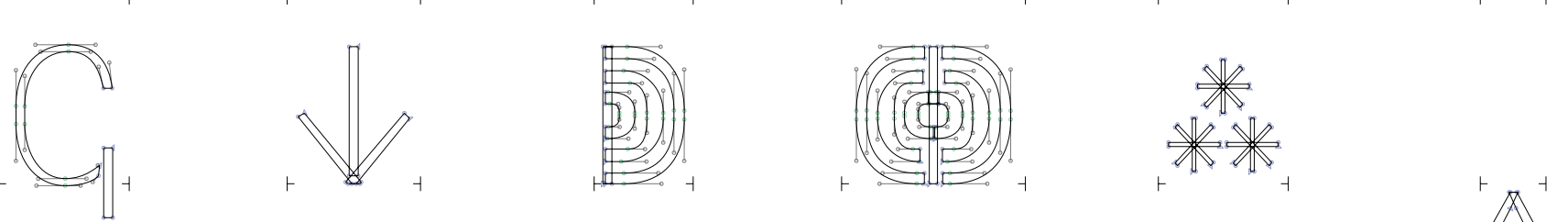

uni2185 2185 uni2186 2186 uni2187 2187 uni2188 2188 asterism 2042 caretSign 2038

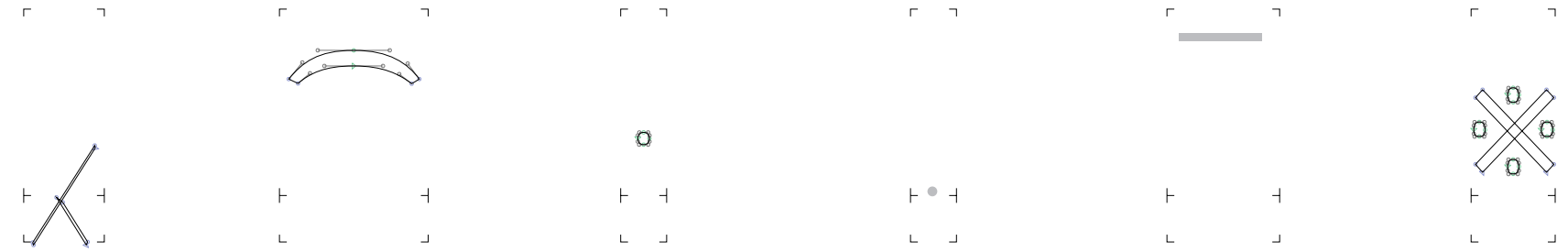

caretinsertionpoint 2041 charactertie 2040 hyphendot 2027 onedotleader 2024 overline 203E referencemark 203B

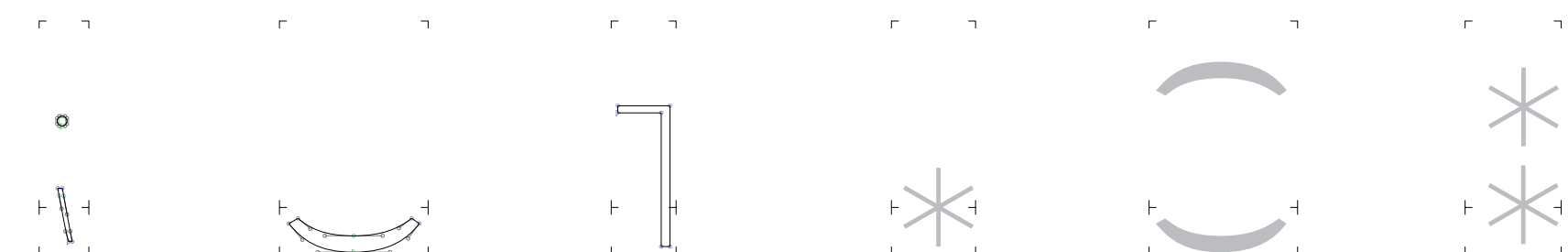



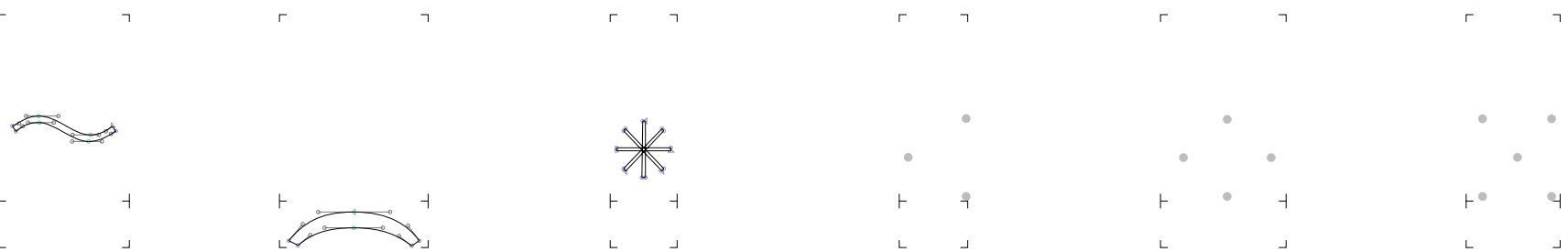

















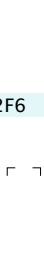
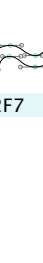
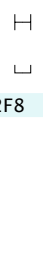
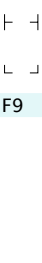
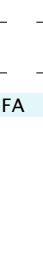
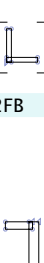
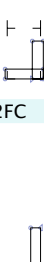
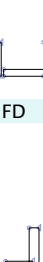
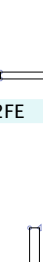
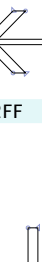
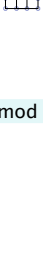
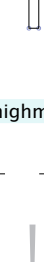
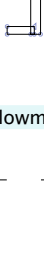
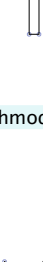
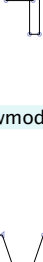
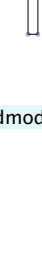

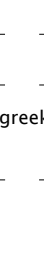
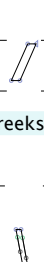
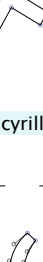
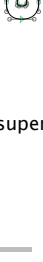
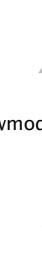
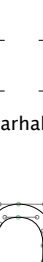
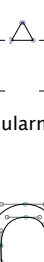
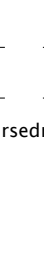
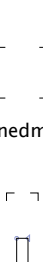
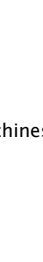
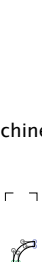
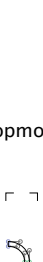
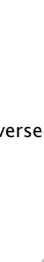
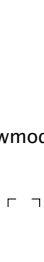
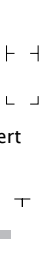
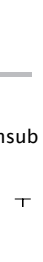
reversedsemicolon 204F undertie 203F uni204A 204A uni204E 204E uni2050 2050 uni2051 2051

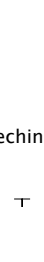
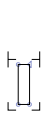









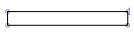

uni2053 2053 uni2054 2054 uni2055 2055 uni2056 2056 uni2058 2058 uni2059 2059





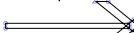

uni205A 205A	uni205B 205B	uni205C 205C	uni205D 205D	uni205E 205E	verticalbardbl 2016
hyphen_ 2010	hyphennobreak 2011	underscoredbl 2017	quotereversed 2018	quotedblreversed 201F	uni27EF 27EF
uniA92E A92E	uni2009.fra	afi300 200F	afi57596 200E	afi57598 200D	afi61664 200C
zerowidthjoiner FEFF	CR	eurocurrency 20A0	uni20B0 20B0	uni20B6 20B6	uni20B7 20B7
uni20BB 20BB	uni2052 2052	bullseye 0298	published 2117	lsquare 2113	estimated 212E
degreecentigrade 2103	degreefahrenheit 2109	ounce 2125	spaceopenbox 2423	uni214F 214F	uni2B4E 2B4E
uni2B4F 2B4F	uni2B5A 2B5A	uni2B5B 2B5B	uni2B5C 2B5C	uni2B5D 2B5D	uni2B5E 2B5E
uni2B5F 2B5F	versicle 2123	arrowheaddownmod 02C5	arrowheadleftmod 02C2	arrowheadrightmod 02C3	arrowheadupmod 02C4
dblapostrophe 02EE	downtackmod 02D5	lowdownarrowheadmod 02EF	minusmod 02D7	plusmod 02D6	rhotichookmod 02DE





					
ringhalfleftcentered 02D3	ringhalfrightcentered 02D2	uni02EA 02EA	uni02EB 02EB	uni02EC 02EC	uni02ED 02ED
					
uni02F0 02F0	uni02F1 02F1	uni02F2 02F2	uni02F3 02F3	uni02F4 02F4	uni02F5 02F5
					
uni02F6 02F6	uni02F7 02F7	uni02F8 02F8	uni02F9 02F9	uni02FA 02FA	uni02FB 02FB
					
uni02FC 02FC	uni02FD 02FD	uni02FE 02FE	uni02FF 02FF	uptackmod 02D4	tonebarextrahighmod.cn 02E5
					
tonebarextralowmod.cn 02E9	tonebarhighmod.cn 02E6	tonebarlowmod.cn 02E8	tonebarmidmod.cn 02E7	uni03F6 03F6	numeralgreek 0374
					
numeralgreeksub 0375	thousandcyrillic 0482	gammasuper 02E0	acutelowmod 02CF	colontriangularhalfmod 02D1	colontriangularmod 02D0
					
commareversedmod 02BD	commaturnedmod 02BB	firsttonechinese 02C9	fourthtonechinese 02CB	glottalstopmod 02C0	glottalstopreversedmod 02C1
					
gravelowmod 02CE	linevert 02C8	macronsub 02CD	ringhalfleft 02BF	ringhalfright 02BE	secondtonechinese 02CA
					
verticalinelowmod 02CC	overscorenosp 0305	linevertnosp 030D	linevertdblnosp 030E	candrabindunosp 0310	commaturnsupnosp 0312





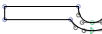
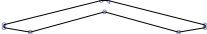

commaabovecmb 0313	commasuprevnosp 0314	commaaboverightcmb 0315	gravesubnosp 0316	acutesubnosp 0317	tackleftsubnosp 0318
tackrightsubnosp 0319	anglesupnosp 031A	ringlefthalfsubnosp 031C	tackupsubnosp 031D	tackdownsubnosp 031E	hooksubpalatnosp 0321
hooksubretronsp 0322	linevertsubnosp 0329	bridgesubnosp 032A	archdblsubnosp 032B	caronbelowcmb 032C	breveinvsubnosp 032F
macronsubnosp 0331	underscoredblno 0333	tildemidnosp 0334	barmidshortnosp 0335	barmidlongnosp 0336	slashshortnosp 0337
slashlongnosp 0338	ringrighthalfsubnosp 0339	bridgeinvsubnosp 033A	squaresubnosp 033B	seagullsubnosp 033C	xsupnosp 033D
tildevertsupnosp 033E	overscoredblno 033F	graveleftnosp 0340	acuterightnosp 0341	uni0346 0346	uni0348 0348
uni0349 0349	uni034A 034A	uni034B 034B	uni034C 034C	uni034D 034D	uni034E 034E
uni034F 034F	arrowheadrightabovecom 0350	uni0351 0351	uni0352 0352	uni0353 0353	uni0354 0354
uni0355 0355	uni0356 0356	uni0357 0357	uni0358 0358	uni0359 0359	uni035A 035A







					
+	+	+	+	+	+
⊥	⊥	⊥	⊥	⊥	⊥
uni035B 035B	uni035C 035C	uni035D 035D	uni035E 035E	uni035F 035F	tildedoublecmb 0360







					
+	+	+	+	+	+
⊥	⊥	⊥	⊥	⊥	⊥
breveinverteddoublecmb 0361	uni0362 0362	uni1DC0 1DC0	uni1DC1 1DC1	uni1DC2 1DC2	uni1DC3 1DC3





					
+	+	+	+	+	+
⊥	⊥	⊥	⊥	⊥	⊥
uni1DC4 1DC4	uni1DC5 1DC5	uni1DC6 1DC6	uni1DC7 1DC7	uni1DC8 1DC8	uni1DC9 1DC9

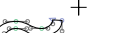

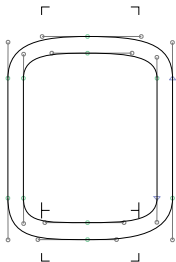

					
+	+	+	+	+	+
⊥	⊥	⊥	⊥	⊥	⊥
uni1DCB 1DCB	uni1DCC 1DCC	uni1DCD 1DCD	uni1DCE 1DCE	uni1DCF 1DCF	uni1DD0 1DD0

					
+	+	+	+	+	+
⊥	⊥	⊥	⊥	⊥	⊥
uni1DD1 1DD1	uni1DD2 1DD2	uni1DE8 1DE8	uni1DEA 1DEA	uni1DEB 1DEB	uni1DEC 1DEC

					
+	+	+	+	+	+
⊥	⊥	⊥	⊥	⊥	⊥
uni1DED 1DED	uni1DEE 1DEE	uni1DEF 1DEF	uni1DF0 1DF0	uni1DF1 1DF1	uni1DF2 1DF2

					
+	+	+	+	+	+
⊥	⊥	⊥	⊥	⊥	⊥
uni1DF3 1DF3	uni1DF4 1DF4	uni1DF5 1DF5	uni1DFC 1DFC	uni1DFD 1DFD	uni1DFE 1DFE

					
+	+	+	+	+	+
⊥	⊥	⊥	⊥	⊥	⊥
uni1DFE 1DFE	uni20DB 20DB	uni20DC 20DC	uni20E3 20E3	uni20E8 20E8	uni20F0 20F0

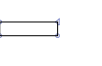
					
+	+	+	+	+	+
⊥	⊥	⊥	⊥	⊥	⊥
uniFE20 FE20	uniFE21 FE21	uniFE22 FE22	uniFE23 FE23	uniFE24 FE24	uniFE25 FE25

uniFE26 FE26	uniFE27 FE27	uniFE28 FE28	uniFE29 FE29	uniFE2A FE2A	uniFE2B FE2B	
uniFE2C FE2C	uniFE2D FE2D	macronacutecomb.cn	macrongravecomb.cn	macronacutecomb.lc	macrongravecomb.lc	
perispomenigreekcmb 0342	koroniscmb 0343	diaeresistonosp 0344	iotasubnosp 0345	uni1FBF 1FBF	uni1FBD 1FBD	
uni1FFE 1FFE	uni1FCD 1FCD	uni1FDD 1FDD	uni1FCE 1FCE	uni1FDE 1FDE	uni1FCF 1FCF	
uni1FDF 1FDF	uni1FED 1FED	uni1FEE 1FEE	uni1FC1 1FC1	uni1FEF 1FEF	uni1FFD 1FFD	
uni1FC0 1FC0	uni1FFE.tonos	uni1FCD.tonos	uni1FDD.tonos	uni1FCE.tonos	uni1FDE.tonos	
uni1FCF.tonos	uni1FDF.tonos	uni1FEF.tonos	uni1FFD.tonos	titlocyrilliccmb 0483	palatalizationcyrilliccmb 0484	
dasiapneumatacyrilliccmb0485	psilipneumatacyrilliccmb 0486	uni0487 0487	uni0488 0488	uni0489 0489	uniA69F A69F	
uni0363 0363	uni0364 0364	uni0365 0365	uni0366 0366	uni0367 0367	uni0368 0368	

+
⊥

+
⊥

+
⊥

+
⊥

+
⊥

+
⊥

uni0369 0369

uni036A 036A

uni036B 036B

uni036C 036C

uni036D 036D

uni036E 036E

+
⊥

+
⊥

+
⊥

+
⊥

+
⊥

+
⊥

uni036F 036F

uni1DCA 1DCA

uni1DD3 1DD3

uni1DD4 1DD4

uni1DD5 1DD5

uni1DD6 1DD6

+
⊥

+
⊥

+
⊥

+
⊥

+
⊥

+
⊥

uni1DD7 1DD7

uni1DD8 1DD8

uni1DD9 1DD9

uni1DDA 1DDA

uni1ddb 1ddb

uni1DDC 1DDC

+
⊥

+
⊥

+
⊥

+
⊥

+
⊥

+
⊥

uni1DDD 1DDD

uni1DDE 1DDE

uni1DDF 1DDF

uni1DE0 1DE0

uni1DE1 1DE1

uni1DE2 1DE2

+
⊥

+
⊥

+
⊥

+
⊥

+
⊥

+
⊥

uni1DE3 1DE3

uni1DE4 1DE4

uni1DE5 1DE5

uni1DE6 1DE6

uni1DE7 1DE7

uni1DE9 1DE9

Omeгарoundcyrillic 047A

omegaroundcyrillic 047B

Omeɡatitlocyrillic 047C

omeɡatitlocyrillic 047D

Otcyrillic 047E

otcyrillic 047F

+
⊥

+
⊥

+
⊥

+
⊥

+
⊥

+
⊥

uni2DFF 2DFF

uniE001 E001

crossbar

acutedotcomb.lc

tildedieresiscomb.lc

dieresisacutecomb.lc

+
⊥

+
⊥

+
⊥

+
⊥

+
⊥

+
⊥

carondotcomb.lc

caronosp

caronsubnosp

ascript_uni02DE

cyrillichookleft

dotmacroncomb.lc

+
⊥

+
⊥

+
⊥

+
⊥

+
⊥

+
⊥

dieresismacroncomb.lc

dieresisgravecomb.lc

largerighthook

tildemacroncomb.lc

macrondieresiscomb.lc

tildeacutecomb

dieresiscaroncomb.lc	cyrillichook	cyrillictic.cn	controlHT	controlSOT	commaaccentright.cn
ringacute.cn	circumflexgravecomb.cn	dieresiscaroncomb.cn	dieresismacroncomb.cn	carondotcomb.cn	breveacutecomb.cn
acutedotcomb.cn	brevegravecomb.cn	circumflexacutecomb.cn	tildedieresiscomb.cn	circumflexhookcomb.cn	brevetildecomb.cn
dieresisacutecomb.cn	dotmacroncomb.cn	macrondieresiscomb.cn	dieresisgravecomb.cn	tildemacroncomb.cn	circumflextildecomb.cn
brevehookcomb.cn	commaaccentrotate.cn	tonostop	cyrillictail.cn	koronisaccentleft.cn	tildeacutecomb.uc