



X10DRH-C  
X10DRH-CT  
X10DRH-i  
X10DRH-iT

USER'S MANUAL

Revision 2.0b

---

The information in this user's manual has been carefully reviewed and is believed to be accurate. The vendor assumes no responsibility for any inaccuracies that may be contained in this document and makes no commitment to update or keep current the information in this manual nor to notify any person or organization of updates. **Please note: For the most up-to-date version of this manual, please see our website at [www.supermicro.com](http://www.supermicro.com).**

Super Micro Computer, Inc. ("Supermicro") reserves the right to make changes to the product described in this manual at any time and without notice. This product, including software and documentation, is the property of Supermicro and/or its licensors and is supplied only under a license. Any use or reproduction of this product is not allowed, except as expressly permitted by the terms of said license.

IN NO EVENT WILL SUPER MICRO COMPUTER, INC. BE LIABLE FOR DIRECT, INDIRECT, SPECIAL, INCIDENTAL, SPECULATIVE, OR CONSEQUENTIAL DAMAGES ARISING FROM THE USE OR INABILITY TO USE THIS PRODUCT OR DOCUMENTATION, EVEN IF ADVISED OF THE POSSIBILITY OF SUCH DAMAGES. IN PARTICULAR, SUPER MICRO COMPUTER, INC. SHALL NOT BE LIABLE FOR ANY HARDWARE, SOFTWARE, OR DATA STORED OR USED WITH THE PRODUCT, INCLUDING THE COSTS OF REPAIRING, REPLACING, INTEGRATING, INSTALLING, OR RECOVERING SUCH HARDWARE, SOFTWARE, OR DATA.

---

Any disputes arising between the manufacturer and the customer shall be governed by the laws of Santa Clara County in the State of California, USA. The State of California, County of Santa Clara shall be the exclusive venue for the resolution of any such disputes. Supermicro's total liability for all claims will not exceed the price paid for the hardware product.

---

FCC Statement: This equipment has been tested and found to comply with the limits for a Class A digital device pursuant to Part 15 of the FCC Rules. These limits are designed to provide reasonable protection against harmful interference when the equipment is operated in an industrial environment. This equipment generates, uses, and can radiate radio frequency energy and, if not installed and used in accordance with the manufacturer's instruction manual, may cause harmful interference with radio communications. Operation of this equipment in a residential area is likely to cause harmful interference, in which case you will be required to correct the interference at your own expense.

---

California Best Management Practices Regulations for Perchlorate Materials: This Perchlorate warning applies only to products containing CR (Manganese Dioxide) Lithium coin cells. "Perchlorate Material-special handling may apply. See [www.dtsc.ca.gov/hazardouswaste/perchlorate](http://www.dtsc.ca.gov/hazardouswaste/perchlorate).

---



Manual Revision 2.0b

Release Date: April 15, 2020

Unless you request and receive written permission from Super Micro Computer, Inc., you may not copy any part of this document.

Information in this document is subject to change without notice. Other products and companies referred to herein are trademarks or registered trademarks of their respective companies or mark holders.

Copyright © 2020 by Super Micro Computer, Inc.  
All rights reserved.

**Printed in the United States of America**

## Preface

This manual is written for system integrators, IT professionals, and knowledgeable end users. It provides information for the installation and use of the X10DRH-C/CT/i/iT motherboard.

### About This Motherboard

The Super X10DRH-C/CT/i/iT motherboard supports dual Intel® E5-2600 v3/v4 Series processors (Socket R3) that offer new Intel Microarchitecture 22nm Process Technology, delivering system performance, power efficiency, and feature sets to address the needs of next-generation computer users. With the PCH C612 built in, the X10DRH-C/CT/i/iT motherboard supports Intel Node Manager 3.0, Intel MCTP Protocol, and Management Engine (ME). This motherboard is ideal for general purpose, storage appliance, and head node server platforms. Please refer to our website (<http://www.supermicro.com>) for CPU and memory support updates.

### Manual Organization

**Chapter 1** describes the features, specifications, and performance of the motherboard. It also provides detailed information about the Intel® PCH C612 chipset.

**Chapter 2** provides hardware installation instructions. Read this chapter when installing the processor, memory modules, and other hardware components into the system. If you encounter any problems, see **Chapter 3**, which describes troubleshooting procedures for video, memory, and system setup stored in CMOS.

**Chapter 4** includes an introduction to BIOS and provides detailed information on running the BIOS Setup Utility.

**Appendix A** defines the BIOS error beep codes.

**Appendix B** lists software installation instructions.

**Appendix C** contains UEFI BIOS recovery instructions.

## Conventions Used in the Manual

Pay special attention to the following symbols for proper system installation:

**Warning:** Important information given to ensure proper system installation or to prevent damage to the components or injury to yourself;

 **Note:** Additional information given to differentiate between models or instructions provided for proper system setup.

## Contacting Supermicro

### Headquarters

Address: Super Micro Computer, Inc.  
980 Rock Ave.  
San Jose, CA 95131 U.S.A.

Tel: +1 (408) 503-8000

Fax: +1 (408) 503-8008

Email: [marketing@supermicro.com](mailto:marketing@supermicro.com) (General Information)  
[support@supermicro.com](mailto:support@supermicro.com) (Technical Support)

Website: [www.supermicro.com](http://www.supermicro.com)

### Europe

Address: Super Micro Computer B.V.  
Het Sterrenbeeld 28, 5215 ML  
's-Hertogenbosch, The Netherlands

Tel: +31 (0) 73-6400390

Fax: +31 (0) 73-6416525

Email: [sales@supermicro.nl](mailto:sales@supermicro.nl) (General Information)  
[support@supermicro.nl](mailto:support@supermicro.nl) (Technical Support)  
[rma@supermicro.nl](mailto:rma@supermicro.nl) (Customer Support)

Website: [www.supermicro.nl](http://www.supermicro.nl)

### Asia-Pacific

Address: Super Micro Computer, Inc.  
3F, No. 150, Jian 1st Rd.  
Zhonghe Dist., New Taipei City 235  
Taiwan (R.O.C)

Tel: +886-(2) 8226-3990

Fax: +886-(2) 8226-3992

Email: [support@supermicro.com.tw](mailto:support@supermicro.com.tw)

Website: [www.supermicro.com.tw](http://www.supermicro.com.tw)

## Table of Contents

### **Preface**

#### **Chapter 1 Overview**

|     |                                                                                                                                 |      |
|-----|---------------------------------------------------------------------------------------------------------------------------------|------|
| 1-1 | Overview .....                                                                                                                  | 1-1  |
| 1-2 | Processor and Chipset Overview.....                                                                                             | 1-11 |
| 1-3 | Special Features .....                                                                                                          | 1-12 |
| 1-4 | System Health Monitoring.....                                                                                                   | 1-12 |
| 1-5 | ACPI Features.....                                                                                                              | 1-13 |
| 1-6 | Power Supply .....                                                                                                              | 1-13 |
| 1-7 | Advanced Power Management.....                                                                                                  | 1-14 |
|     | Intel <sup>®</sup> Intelligent Power Node Manager (NM) (Available when the Supermicro<br>Power Manager [SPM] is installed)..... | 1-14 |
|     | Management Engine (ME) .....                                                                                                    | 1-14 |

#### **Chapter 2 Installation**

|     |                                                                                               |      |
|-----|-----------------------------------------------------------------------------------------------|------|
| 2-1 | Standardized Warning Statements .....                                                         | 2-1  |
| 2-2 | Static-Sensitive Devices.....                                                                 | 2-4  |
| 2-3 | Motherboard Installation.....                                                                 | 2-5  |
| 2-4 | Processor and Heatsink Installation.....                                                      | 2-7  |
|     | Installing the LGA2011 Processor .....                                                        | 2-7  |
|     | Installing a Passive CPU Heatsink .....                                                       | 2-11 |
|     | Removing the CPU and the Heatsink.....                                                        | 2-12 |
| 2-5 | Installing and Removing the Memory Modules.....                                               | 2-13 |
|     | Installing & Removing DIMMs.....                                                              | 2-13 |
|     | Removing Memory Modules .....                                                                 | 2-13 |
| 2-6 | Onboard 3108 SAS Controller with CacheVault Support (Optional for .....<br>X10DRH-C/CT) ..... | 2-16 |
|     | The 3108 CacheVault Kit (Optional) .....                                                      | 2-16 |
|     | Installing the 3108 CacheVault Kit.....                                                       | 2-17 |
| 2-7 | Control Panel Connectors and I/O Ports .....                                                  | 2-18 |
|     | Back Panel Connectors and I/O Ports.....                                                      | 2-18 |
|     | Back Panel I/O Port Locations and Definitions .....                                           | 2-18 |
|     | Serial Ports.....                                                                             | 2-19 |
|     | Video Connection .....                                                                        | 2-19 |
|     | Universal Serial Bus (USB).....                                                               | 2-20 |
|     | Ethernet Ports .....                                                                          | 2-21 |
|     | Unit Identifier Switches/UID LED Indicators.....                                              | 2-22 |
|     | Front Control Panel.....                                                                      | 2-23 |
|     | Front Control Panel Pin Definitions.....                                                      | 2-24 |

|      |                                               |      |
|------|-----------------------------------------------|------|
|      | NMI Button .....                              | 2-24 |
|      | Power LED .....                               | 2-24 |
|      | HDD/UID LED .....                             | 2-25 |
|      | NIC1/NIC2 LED Indicators .....                | 2-25 |
|      | Overheat (OH)/Fan Fail/PWR Fail/UID LED ..... | 2-26 |
|      | Power Fail LED .....                          | 2-26 |
|      | Reset Button .....                            | 2-27 |
|      | Power Button .....                            | 2-27 |
| 2-8  | Connecting Cables.....                        | 2-28 |
|      | Power Connectors .....                        | 2-28 |
|      | Fan Headers.....                              | 2-29 |
|      | Chassis Intrusion .....                       | 2-29 |
|      | Internal Speaker .....                        | 2-30 |
|      | Power LED/Speaker.....                        | 2-30 |
|      | TPM/Port 80 Header .....                      | 2-31 |
|      | NVMe I <sup>2</sup> C Header.....             | 2-31 |
|      | Power SMB (I <sup>2</sup> C) Connector .....  | 2-32 |
|      | IPMB.....                                     | 2-32 |
|      | I-SGPIO 1/2 Headers .....                     | 2-33 |
|      | Standby Power Header .....                    | 2-33 |
| 2-9  | Jumper Settings .....                         | 2-34 |
|      | Explanation of Jumpers .....                  | 2-34 |
|      | LAN Enable/Disable .....                      | 2-34 |
|      | CMOS Clear .....                              | 2-35 |
|      | Watch Dog Enable/Disable .....                | 2-35 |
|      | VGA Enable.....                               | 2-36 |
|      | BMC Enable .....                              | 2-36 |
|      | I <sup>2</sup> C Bus for VRM.....             | 2-37 |
|      | Manufacturer Mode Select.....                 | 2-37 |
|      | SAS Enable (X10DRH-C/CT only).....            | 2-38 |
| 2-10 | Onboard LED Indicators .....                  | 2-39 |
|      | GLAN LEDs.....                                | 2-39 |
|      | IPMI-Dedicated LAN LEDs.....                  | 2-39 |
|      | Onboard Power LED .....                       | 2-40 |
|      | BMC Heartbeat LED .....                       | 2-40 |
|      | SAS Activity LED (For X10DRH-C/CT).....       | 2-41 |
|      | SAS Fault LED (For X10DRH-C/CT) .....         | 2-41 |
|      | SAS Heartbeat LED (For X10DRH-C/CT) .....     | 2-42 |
| 2-11 | SATA/SAS Connections .....                    | 2-43 |

|                                          |      |
|------------------------------------------|------|
| SATA 3.0 and S-SATA 3.0 Connections..... | 2-43 |
| SAS Ports (X10DRH-C/CT Only).....        | 2-44 |

**Chapter 3 Troubleshooting**

|                                            |     |
|--------------------------------------------|-----|
| 3-1 Troubleshooting Procedures .....       | 3-1 |
| 3-2 Technical Support Procedures .....     | 3-5 |
| 3-3 Battery Removal and Installation ..... | 3-6 |
| 3-4 Frequently Asked Questions .....       | 3-7 |
| 3-5 Returning Merchandise for Service..... | 3-9 |

**Chapter 4 BIOS**

|                                        |      |
|----------------------------------------|------|
| 4-1 Introduction.....                  | 4-1  |
| 4-2 Main Setup .....                   | 4-2  |
| 4-3 Advanced Setup Configurations..... | 4-4  |
| 4-4 Event Logs .....                   | 4-40 |
| 4-5 IPMI .....                         | 4-42 |
| 4-6 Security Settings .....            | 4-44 |
| 4-7 Boot Settings.....                 | 4-45 |
| 4-8 Save & Exit .....                  | 4-46 |

**Appendix A BIOS POST Error Beep Codes**

|                                     |     |
|-------------------------------------|-----|
| A-1 BIOS POST Error Beep Codes..... | A-1 |
|-------------------------------------|-----|

**Appendix B Software Installation Instructions**

|                                                                  |     |
|------------------------------------------------------------------|-----|
| B-1 Installing Software Programs .....                           | B-1 |
| B-2 SuperDoctor <sup>®</sup> 5 .....                             | B-2 |
| B-3 Logging into the BMC (Baseboard Management Controller) ..... | B-3 |

**Appendix C UEFI BIOS Recovery Instructions**

|                                                                     |     |
|---------------------------------------------------------------------|-----|
| C-1 An Overview to the UEFI BIOS .....                              | C-1 |
| C-2 How to Recover the UEFI BIOS Image (-the Main BIOS Block).....  | C-1 |
| C-3 To Recover the Main BIOS Block Using a USB-Attached Device..... | C-1 |



# Chapter 1

## Overview

### 1-1 Overview

#### Checklist

Congratulations on purchasing your computer motherboard from an acknowledged leader in the industry. Supermicro boards are designed with the utmost care and attention to detail to provide you with the highest standards in quality and performance.

Please check that the following items have all been included with your motherboard. If anything listed here is damaged or missing, contact your retailer.

The following items are included in the retail box:

- One (1) Supermicro Mainboard
- Six (6) SATA Cables (CBL-0044L) (For *X10DRH-i/IT*.)
- Two (2) SATA Cables (CBL-0044L) (*X10DRH-C/CT*)
- Two (2) SAS Cables (CBL-SAST-0532) (*X10DRH-C/CT*)
- One (1) I/O Shield (MCP-260-00042-0N)
- One (1) Quick Reference Guide (MNL-1628-QRG)



**Note 1:** For your system to work properly, please follow the links below to download all necessary drivers and utilities and the user's manual for your motherboard.

- Supermicro Product Manuals: <http://www.supermicro.com/support/manuals/>
- Product Drivers and Utilities: <http://www.supermicro.com/wftp>



**Note 2:** For safety considerations, please refer to the complete list of safety warnings posted on the Supermicro website at [http://www.supermicro.com/about/policies/safety\\_information.cfm](http://www.supermicro.com/about/policies/safety_information.cfm).

If you have any questions, please contact our support team at [support@supermicro.com](mailto:support@supermicro.com).

## Motherboard Image

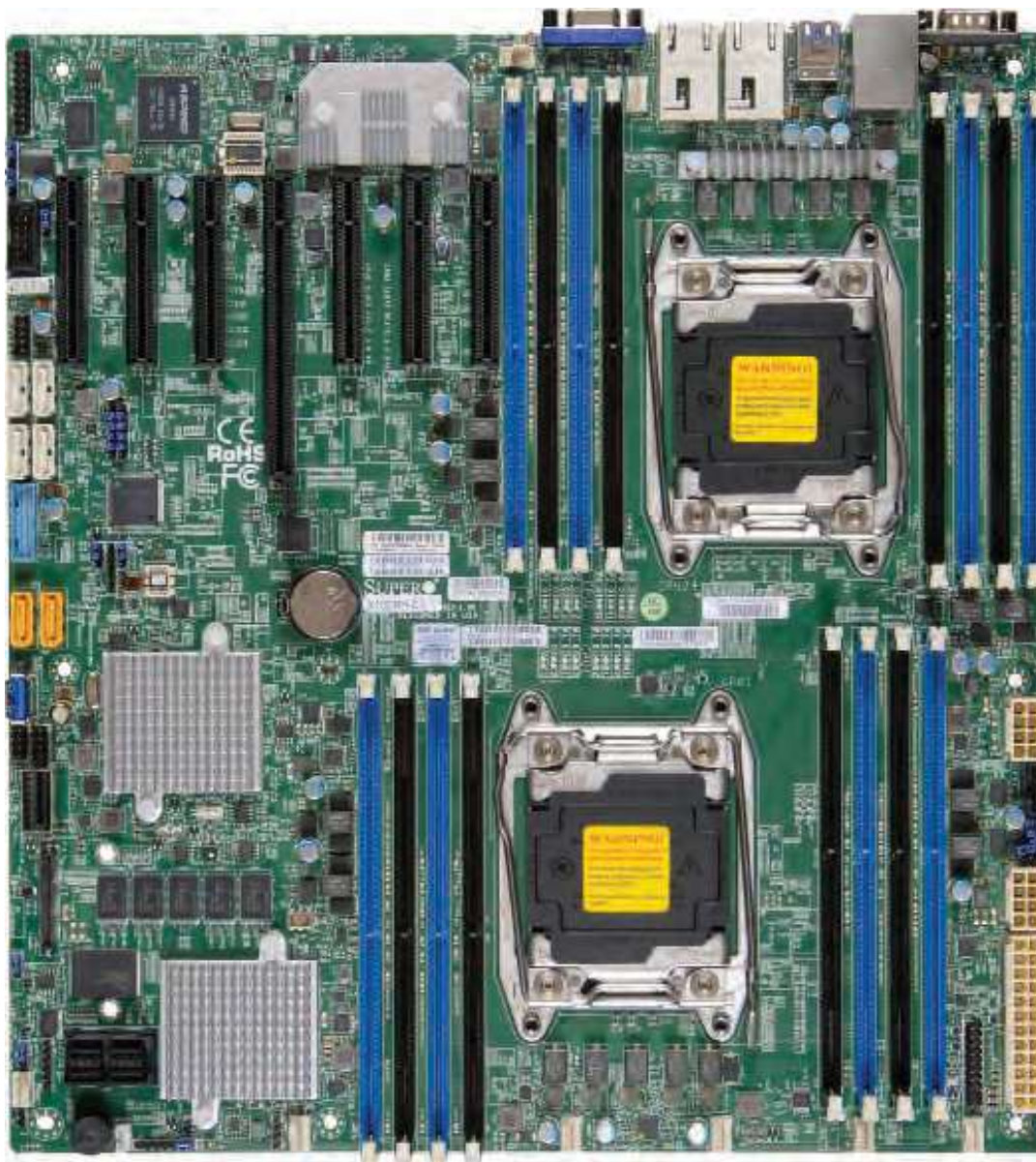

 **Note:** All graphics shown in this manual were based upon the latest PCB revision available at the time of publication of the manual. The motherboard you received may or may not look exactly the same as the graphics shown in this manual.

## Motherboard Layout

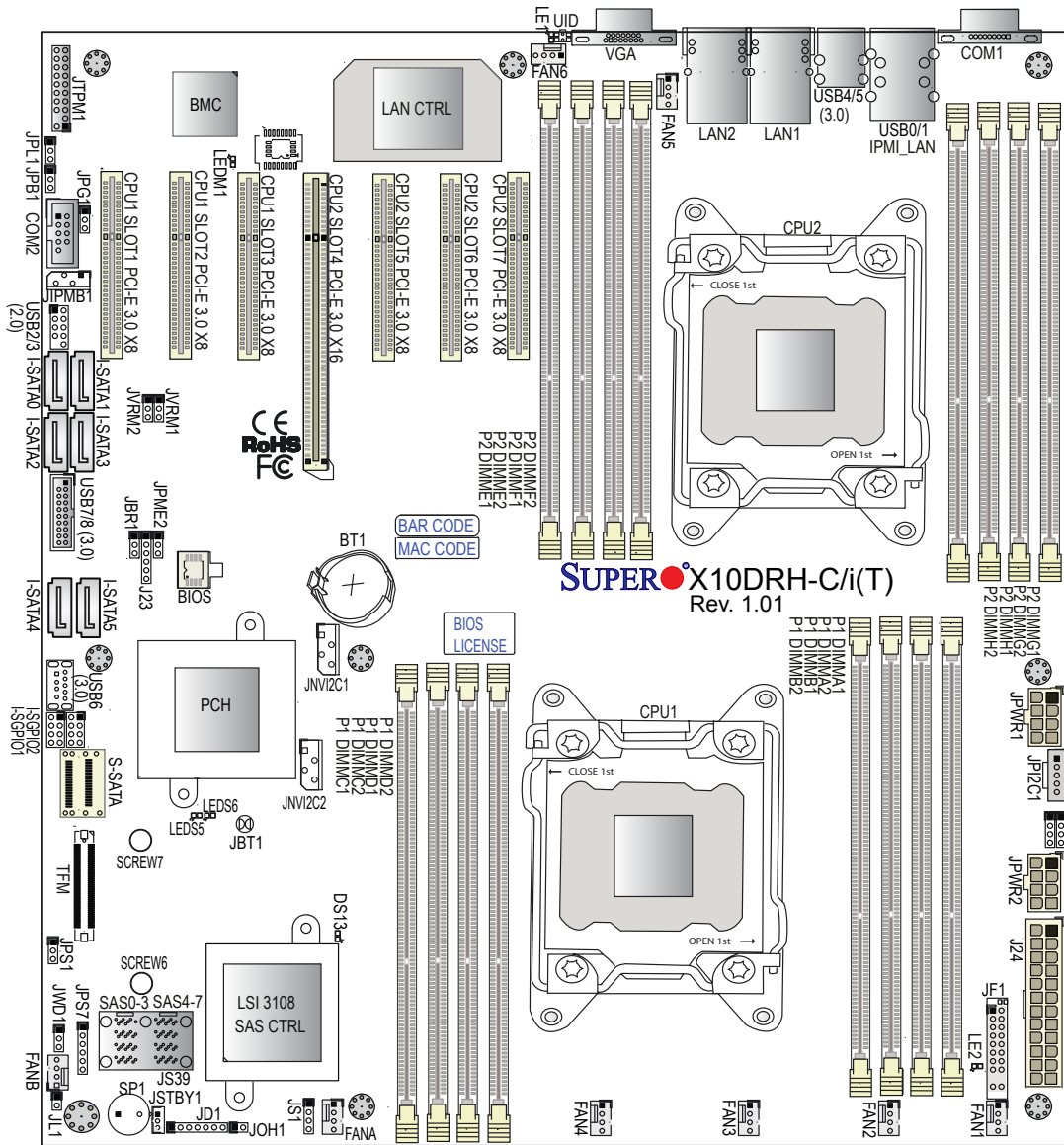

### Differences between X10DRH-C/X10DRH-CT/X10DRH-i/X10DRH-iT

|                                                    | X10DRH-C | X10DRH-CT | X10DRH-i | X10DRH-iT |
|----------------------------------------------------|----------|-----------|----------|-----------|
| SAS Connections (0-3, 4-7)                         | Yes      | Yes       | No       | No        |
| LSI SAS Controller                                 | Yes      | Yes       | No       | No        |
| CacheVault support for the onboard 3108 controller | Yes      | Yes       | No       | No        |
| 10G-LAN (TLAN) (w/X540 LAN Controller)             | No       | Yes       | No       | Yes       |
| GLAN (w/i350 LAN Controller)                       | Yes      | No        | Yes      | No        |

 **Note:** For the latest CPU/Memory updates, please refer to our website at <http://www.supermicro.com/products/motherboard/> for details.

## X10DRH-C/CT/i/iT Quick Reference

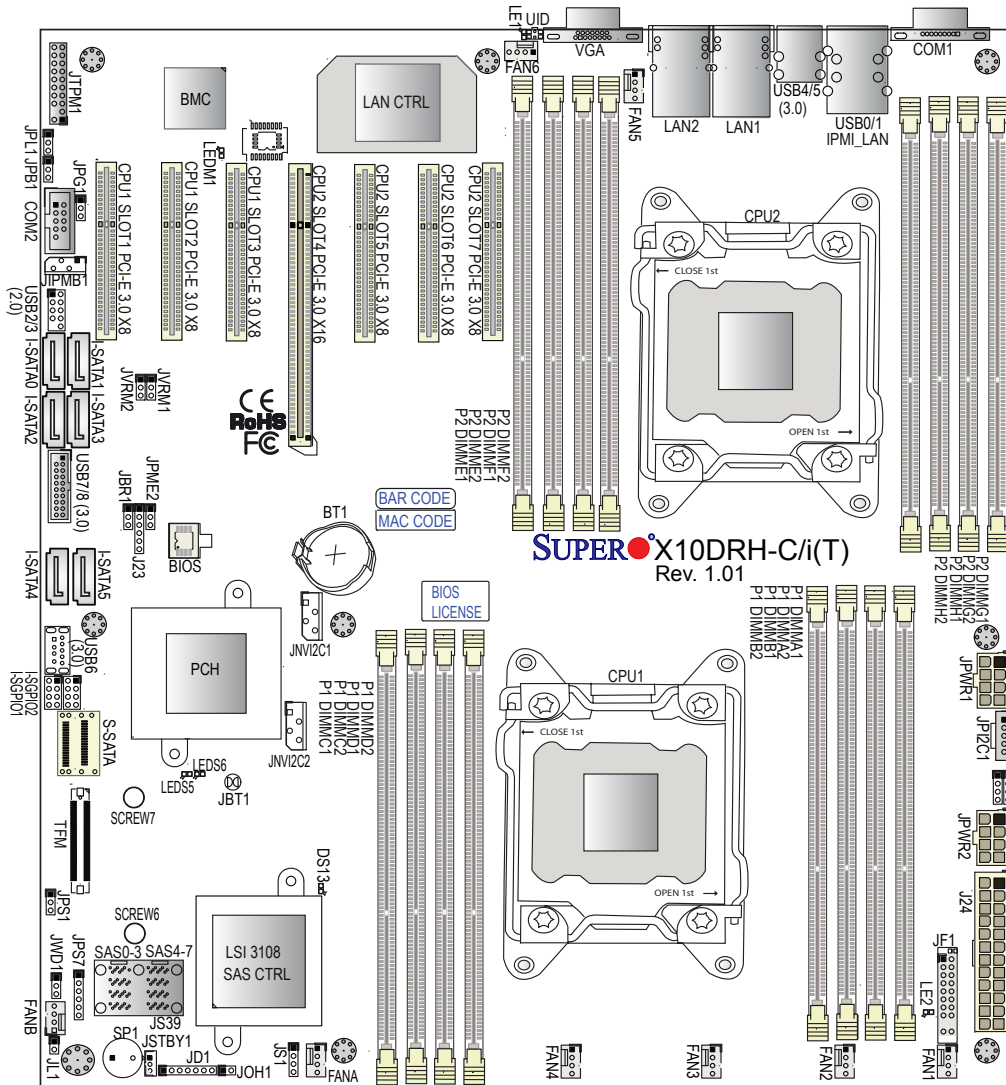

 **Notes:**

- See Chapter 2 for detailed information on jumpers, I/O ports, and JF1 front panel connections.
- "■" indicates the location of Pin 1.
- Jumpers/LED indicators not indicated are used for testing only.
- Please refer to the table on Page 1-3 to see model variations.
- Use only the correct type of onboard CMOS battery as specified by the manufacturer. Do not install the onboard battery upside down to avoid possible explosion.
- To avoid causing interference with other components, please be sure to use an add-on card that is fully compliant with the PCI standard on a PCI slot.

**X10DRH-C/CT/i/iT Jumpers**

| <b>Jumper</b> | <b>Description</b>                                                         | <b>Default Setting</b> |
|---------------|----------------------------------------------------------------------------|------------------------|
| JBT1          | Clear CMOS/Reset BIOS Configuration                                        | See Chapter 2          |
| JPB1          | BMC Enable                                                                 | Pins 1-2 (Enabled)     |
| JPG1          | VGA Enable                                                                 | Pins 1-2 (Enabled)     |
| JPL1          | GLAN1/GLAN2 Enable (X10DRH-C/i)<br>(10G) TLAN1/TLAN2 Enable (X10DRH-CT/iT) | Pins 1-2 (Enabled)     |
| JPME2         | Manufacture (ME) Mode Select                                               | Pins 1-2 (Normal)      |
| JVRM1         | VRM SMB to Clock (to BMC or PCH)                                           | Pins 1-2 (BMC, Normal) |
| JVRM2         | VRM SMB to Data (to BMC or PCH)                                            | Pins 1-2 (BMC, Normal) |
| JWD1          | Watch Dog Timer Enable                                                     | Pins 1-2 (Reset)       |
| JPS1          | SAS Enable (X10DRH-C/CT only)                                              | Pins 1-2 (Enabled)     |

**X10DRH-C/CT/i/iT Connectors**

| <b>Connectors</b>                   | <b>Description</b>                                                                                                                                             |
|-------------------------------------|----------------------------------------------------------------------------------------------------------------------------------------------------------------|
| BT1 (Battery)                       | Onboard CMOS battery (See Chpt. 3 for Used Battery Disposal)                                                                                                   |
| COM1/COM2                           | Backplane COM Port1/Front accessible COM2 header                                                                                                               |
| FAN1-6,A, B                         | CPU/system fan headers (Fan 1-Fan 6, Fan A, Fan B)                                                                                                             |
| J24                                 | 24-pin ATX main power connector (See Warning on Pg. 1-6.)                                                                                                      |
| JD1                                 | Speaker/Power LED header                                                                                                                                       |
| JF1                                 | Front panel control header                                                                                                                                     |
| JIPMB1                              | 4-pin external BMC I <sup>2</sup> C header (for an IPMI card)                                                                                                  |
| JL1                                 | Chassis intrusion header                                                                                                                                       |
| JPI <sup>2</sup> C1                 | Power supply SMBbus I <sup>2</sup> C header                                                                                                                    |
| JPWR1/JPWR2                         | 12V 8-pin power connectors (See Warning on Pg. 1-6.)                                                                                                           |
| JSTBY1                              | Standby power connector                                                                                                                                        |
| JTPM1                               | TPM (Trusted Platform Module)/Port 80 header                                                                                                                   |
| LAN1/LAN2                           | G-bit Ethernet (GLAN) ports 1/2 (X10DRH-C/i)<br>10G-bit Ethernet (TLAN) ports 1/2 (X10DRH-CT/iT)                                                               |
| IPMI_LAN                            | IPMI_dedicated LAN support by the ASpeed controller                                                                                                            |
| I-SATA 0-5                          | SATA 3.0 connectors supported by Intel PCH (I-SATA 0-5), (I-SATA4/I-SATA5: can be used as Supermicro SuperDOM (Disk-on-Module) with built-in power connectors) |
| S-SATA                              | SATA 3.0 vertical connector w/4-SATA connections supported by Intel SCU                                                                                        |
| SAS(0-3,4-7(JS39) (for X10DRH-C/CT) | SAS 3.0 connections (0-3,4-7) supported by the LSI 3108                                                                                                        |
| (CPU1) Slot1                        | PCI-Express 3.0 x8 slot from CPU1                                                                                                                              |
| (CPU1) Slot2                        | PCI-Express 3.0 x8 slot from CPU1                                                                                                                              |

|                    |                                                                                                             |
|--------------------|-------------------------------------------------------------------------------------------------------------|
| (CPU1) Slot3       | PCI-Express 3.0 x8 slot from CPU1                                                                           |
| (CPU2)Slot4        | PCI-Express 3.0 x16 slot from CPU2                                                                          |
| (CPU2)Slot5        | PCI-Express 3.0 x8 slot from CPU2                                                                           |
| (CPU2)Slot6        | PCI-Express 3.0 x8 slot from CPU2                                                                           |
| (CPU2)Slot7        | PCI-Express 3.0 x8 slot from CPU2                                                                           |
| (I-)SGPIO1/2       | Serial_Link General Purpose I/O headers 1/2 for SATA ports (I-SGPIO1 for I-SATA0-3, I-SGPIO2 for I-SATA4/5) |
| SP1                | Internal speaker/buzzer                                                                                     |
| TFM Header         | TFM header used for onboard 3018 CacheVault (Optional for X10DRH-C/CT)                                      |
| UID                | UID (Unit Identification) switch                                                                            |
| (BP) USB 0/1 (2.0) | Back panel USB 2.0 ports 0/1                                                                                |
| (FP) USB 2/3 (2.0) | Front accessible USB 2.0 connections (USB 2/3) header                                                       |
| (BP) USB 4/5 (3.0) | Back panel USB 3.0 ports 4/5                                                                                |
| (FP) USB 7/8 (3.0) | Front accessible USB 3.0 connections (USB 7/8) header                                                       |
| (FP) USB 6 (3.0)   | Front accessible Type A 3.0 connector (USB6)                                                                |
| VGA                | Back panel VGA port                                                                                         |



#### X10DRH-C/CT/i/iT LED Indicators

| LED                 | Description       | State           | Status                |
|---------------------|-------------------|-----------------|-----------------------|
| DS13 (X10DRH-C/CT)  | SAS Heartbeat LED | Green: Blinking | SAS Normal            |
| LE1                 | Rear UID LED      | Blue: On        | Unit Identified       |
| LE2                 | Onboard PWR LED   | On              | Power On              |
| LEDM1               | BMC Heartbeat LED | Green: Blinking | BMC Normal            |
| LEDS5 (X10DRH-C/CT) | SAS Activity LED  | Green: Blinking | SAS Active            |
| LEDS6 (X10DRH-C/CT) | SAS Fault LED     | Red: On         | SAS Error(s) Detected |

#### Warning!

- To avoid causing interference with other components, please be sure to use an add-on card that is fully compliant with the PCI-standard on a PCI slot.
- Be sure to use a power supply that contains a 24-pin and two 8-pin power connectors to avoid damaging the power supply or the motherboard. Connect the power supply to the 24-pin power connector (J24) and two 8-pin power connectors (JPWR1, JPWR2) on the motherboard. Failure to do so may void the manufacturer warranty on your power supply and motherboard.

## Motherboard Features

|                        |                                                                                                                                                                                                                                                                                                                                                                                                                                                                                                                                                                                                   |                                                                                                                                                                     |
|------------------------|---------------------------------------------------------------------------------------------------------------------------------------------------------------------------------------------------------------------------------------------------------------------------------------------------------------------------------------------------------------------------------------------------------------------------------------------------------------------------------------------------------------------------------------------------------------------------------------------------|---------------------------------------------------------------------------------------------------------------------------------------------------------------------|
| <b>CPU</b>             | <ul style="list-style-type: none"> <li>Dual Intel® E5-2600 v3/v4 Series processors (Socket R3-LGA 2011); each processor supports dual full-width Intel QuickPath Interconnect (QPI) links (of up to 9.6 GT/s one direction per QPI)</li> </ul>  <b>Note:</b> Both CPUs need to be installed for full access to the PCI-E slots, DIMM slots, and on-board controllers. Refer to the block diagram on page 1-10 to determine which slots or devices may be affected.                                               |                                                                                                                                                                     |
| <b>Memory</b>          | <ul style="list-style-type: none"> <li>Integrated memory controller supports up to 1024 GB of Load Reduced (LRDIMM) or 512 GB of Registered (RDIMM) DDR4 (288-pin) ECC 2133/1866/1600 MHz modules in 16 slots</li> </ul>  <b>Note 1:</b> Memory speed support depends on the processors used in the system. <p><b>Note 2:</b> For the latest CPU/memory updates, please refer to our website at <a href="http://www.supermicro.com/products/motherboard">http://www.supermicro.com/products/motherboard</a>.</p> |                                                                                                                                                                     |
|                        | <b>DIMM Sizes</b>                                                                                                                                                                                                                                                                                                                                                                                                                                                                                                                                                                                 |                                                                                                                                                                     |
|                        | <ul style="list-style-type: none"> <li>DIMM</li> </ul>                                                                                                                                                                                                                                                                                                                                                                                                                                                                                                                                            | Up to 64GB at 1.2V                                                                                                                                                  |
| <b>Chipset</b>         | <ul style="list-style-type: none"> <li>Intel® PCH C612</li> </ul>                                                                                                                                                                                                                                                                                                                                                                                                                                                                                                                                 |                                                                                                                                                                     |
| <b>Expansion Slots</b> | <ul style="list-style-type: none"> <li>Six (6) PCI Express 3.0 x8 slots (CPU1 Slot1-Slot3, CPU2 Slot5-Slot7)</li> <li>One (1) PCI-Express 3.0 x16 slot (CPU2 Slot4)</li> </ul>                                                                                                                                                                                                                                                                                                                                                                                                                    |                                                                                                                                                                     |
| <b>Graphics</b>        | <ul style="list-style-type: none"> <li>Graphics controller via ASpeed 2400 BMC</li> </ul>                                                                                                                                                                                                                                                                                                                                                                                                                                                                                                         |                                                                                                                                                                     |
| <b>Network</b>         | <ul style="list-style-type: none"> <li>Intel® i350 Gigabit (10/100/1000 Mb/s) Ethernet Controller for LAN 1/LAN 2 ports (X10DRH-C/i)</li> <li>Intel® X540 10-Gigabit (T) Ethernet Controller for LAN 1/LAN 2 ports (X10DRH-CT/iT)</li> </ul>                                                                                                                                                                                                                                                                                                                                                      |                                                                                                                                                                     |
|                        | <ul style="list-style-type: none"> <li>ASpeed AST 2400 Baseboard Controller (BMC) supports IPMI 2.0</li> </ul>                                                                                                                                                                                                                                                                                                                                                                                                                                                                                    |                                                                                                                                                                     |
| <b>I/O Devices</b>     | <b>SATA/SAS Connections</b>                                                                                                                                                                                                                                                                                                                                                                                                                                                                                                                                                                       |                                                                                                                                                                     |
|                        | <ul style="list-style-type: none"> <li>SATA 3.0</li> </ul>                                                                                                                                                                                                                                                                                                                                                                                                                                                                                                                                        | <p>Six (6) SATA 3.0 ports supported by Intel PCH (I-SATA 0-5)</p> <p>One (1) SATA 3.0 vertical connector with 4 connections supported by the SCU (S-SATA, JS39)</p> |

|                           |                                                                                                                                                                                                                                        |                                                                                                                                                               |
|---------------------------|----------------------------------------------------------------------------------------------------------------------------------------------------------------------------------------------------------------------------------------|---------------------------------------------------------------------------------------------------------------------------------------------------------------|
|                           | <ul style="list-style-type: none"> <li>RAID (PCH)</li> </ul>                                                                                                                                                                           | RAID 0, 1, 10, 5                                                                                                                                              |
|                           | <ul style="list-style-type: none"> <li>SAS 3.0 (X10DRH-C/CT Only)</li> </ul>                                                                                                                                                           | Eight (8) SAS/SATA 3.0 connections (SAS 0-3, 4-7)                                                                                                             |
|                           | <ul style="list-style-type: none"> <li>RAID (LSI3108) (X10DRH-C/CT Only)</li> </ul>                                                                                                                                                    | RAID 0, 1, 5, 6, 10, 50, 60 Hardware RAID + 2GB cache from the LSI 3108 SAS controller with optional CacheVault support (See pages 2-16, 2-17 for more info.) |
|                           | <b>IPMI 2.0</b>                                                                                                                                                                                                                        |                                                                                                                                                               |
|                           | <ul style="list-style-type: none"> <li>IPMI 2.0 supported by ASpeed AST 2400</li> </ul>                                                                                                                                                |                                                                                                                                                               |
|                           | <b>Serial (COM) Port</b>                                                                                                                                                                                                               |                                                                                                                                                               |
|                           | <ul style="list-style-type: none"> <li>One (1) Fast UART 16550 port on the I/O back panel</li> <li>One (1) serial-port header</li> </ul>                                                                                               |                                                                                                                                                               |
| <b>Peripheral Devices</b> | <b>USB Devices</b>                                                                                                                                                                                                                     |                                                                                                                                                               |
|                           | <ul style="list-style-type: none"> <li>Two (2) USB 2.0 ports on the rear I/O panel (USB 0/1)</li> <li>Two (2) USB 3.0 ports on the rear I/O panel (USB 4/5)</li> </ul>                                                                 |                                                                                                                                                               |
|                           | <ul style="list-style-type: none"> <li>One (1) internal USB 2.0 header for two (2) USB 2.0 connections for front-panel support (USB 2/3)</li> </ul>                                                                                    |                                                                                                                                                               |
|                           | <ul style="list-style-type: none"> <li>One (1) type-A USB 3.0 connector for front access (USB6)</li> </ul>                                                                                                                             |                                                                                                                                                               |
|                           | <ul style="list-style-type: none"> <li>One (1) internal USB 3.0 header for two (2) USB 3.0 connections for front panel support (USB 7/8)</li> </ul>                                                                                    |                                                                                                                                                               |
| <b>BIOS</b>               | <ul style="list-style-type: none"> <li>16 MB SPI AMI BIOS<sup>®</sup> SM Flash UEFI BIOS</li> </ul>                                                                                                                                    |                                                                                                                                                               |
|                           | <ul style="list-style-type: none"> <li>ACPI 2.0/3.0/4.0, USB keyboard, Plug-and-Play (PnP), SPI dual/quad speed support, RTC (Real-Time Clock) Wake-Up, and SMBIOS 2.3</li> </ul>                                                      |                                                                                                                                                               |
| <b>Power Management</b>   | <ul style="list-style-type: none"> <li>ACPI Power Management</li> </ul>                                                                                                                                                                |                                                                                                                                                               |
|                           | <ul style="list-style-type: none"> <li>Main switch override mechanism</li> </ul>                                                                                                                                                       |                                                                                                                                                               |
|                           | <ul style="list-style-type: none"> <li>Power-on mode for AC power recovery</li> </ul>                                                                                                                                                  |                                                                                                                                                               |
|                           | <ul style="list-style-type: none"> <li>Intel<sup>®</sup> Intelligent Power Node Manager 3.0 (available when the Supermicro Power Manager [SPM] is installed and a special power supply is used. See the note on Page 1-14.)</li> </ul> |                                                                                                                                                               |
|                           | <ul style="list-style-type: none"> <li>Management Engine (ME)</li> </ul>                                                                                                                                                               |                                                                                                                                                               |



|                                 |                                                                                                                                                                                              |
|---------------------------------|----------------------------------------------------------------------------------------------------------------------------------------------------------------------------------------------|
| <b>System Health Monitoring</b> | <b>System Health/CPU Monitoring</b>                                                                                                                                                          |
|                                 | <ul style="list-style-type: none"> <li>Onboard voltage monitoring for 1.2V +3.3V, 3.3V standby, +5V, +5V standby, +12V, CPU core, memory, chipset, BMC, PCH, and battery voltages</li> </ul> |
|                                 | <ul style="list-style-type: none"> <li>CPU/system overheat LED and control</li> </ul>                                                                                                        |
|                                 | <ul style="list-style-type: none"> <li>CPU Thermal Trip support</li> </ul>                                                                                                                   |
|                                 | <ul style="list-style-type: none"> <li>Status monitor for speed control</li> </ul>                                                                                                           |
|                                 | <ul style="list-style-type: none"> <li>Status monitor for on/off control</li> </ul>                                                                                                          |
|                                 | <ul style="list-style-type: none"> <li>CPU Thermal Design Power (TDP) support of up to 145W (See Note 1 below.)</li> </ul>                                                                   |
|                                 | <b>Fan Control</b>                                                                                                                                                                           |
|                                 | <ul style="list-style-type: none"> <li>Fan status monitoring via IPMI connections</li> </ul>                                                                                                 |
|                                 | <ul style="list-style-type: none"> <li>Dual cooling zone</li> </ul>                                                                                                                          |
|                                 | <ul style="list-style-type: none"> <li>Multi-speed fan control via onboard BMC</li> </ul>                                                                                                    |
|                                 | <ul style="list-style-type: none"> <li>Pulse Width Modulation (PWM) fan control</li> </ul>                                                                                                   |
| <b>System Management</b>        | <ul style="list-style-type: none"> <li>PECI (Platform Environment Control Interface) 2.0 support</li> </ul>                                                                                  |
|                                 | <ul style="list-style-type: none"> <li>UID (Unit Identification)/Remote UID</li> </ul>                                                                                                       |
|                                 | <ul style="list-style-type: none"> <li>System resource alert via SuperDoctor® 5</li> </ul>                                                                                                   |
|                                 | <ul style="list-style-type: none"> <li>SuperDoctor® 5, Watch Dog, NMI</li> </ul>                                                                                                             |
|                                 | <ul style="list-style-type: none"> <li>Chassis intrusion header and detection</li> </ul>                                                                                                     |
| <b>Dimensions</b>               | <ul style="list-style-type: none"> <li>12.00" (L) x 13.00" (W) (304.80 mm x 330.20 mm)</li> </ul>                                                                                            |

 **Note 1:** The CPU maximum thermal design power (TDP) is subject to chassis and heatsink cooling restrictions. For proper thermal management, please check the chassis and heatsink specifications for proper CPU TDP sizing.

**Note 2:** For IPMI configuration instructions, please refer to the Embedded IPMI Configuration User's Guide available at <http://www.supermicro.com/support/manuals/>.

**Note 3:** It is strongly recommended that you change BMC log-in information upon initial system power-on. The manufacture default username is ADMIN and the password is ADMIN. For proper BMC configuration, please refer to [http://www.supermicro.com/products/info/files/IPMI/Best\\_Practices\\_BMC\\_Security.pdf](http://www.supermicro.com/products/info/files/IPMI/Best_Practices_BMC_Security.pdf).

**Note 4:** To avoid causing interference with other components, please be sure to use an add-on card that is fully compliant with the PCI-standard on a PCI slot.

# X10DRH-C/i (T)

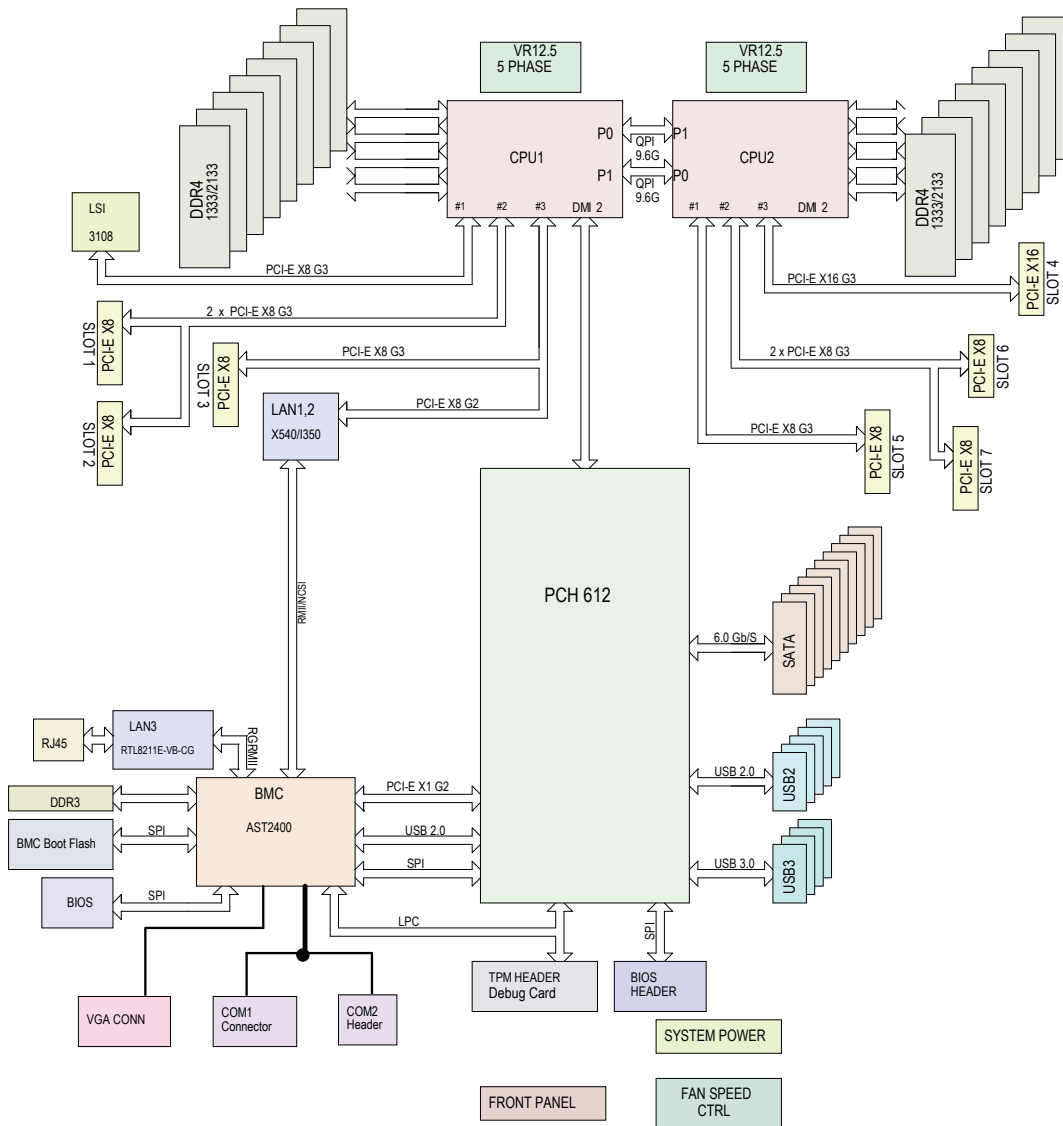

## System Block Diagram

 **Note 1:** This is a general block diagram and may not exactly represent the features on your motherboard. See the Motherboard Features pages for the actual specifications of each motherboard.

**Note 2:** Both CPUs need to be installed for full access to the PCI-E slots, DIMM slots, and onboard controllers. Refer to the block diagram above to determine which slots or devices may be affected.

## 1-2 Processor and Chipset Overview

Built upon the functionality and capability of the Intel E5-2600 v3/v4 Series processors (Socket R3) and the Intel C612 PCH, the X10DRH-C/CT/i/iT motherboard provides system performance, power efficiency, and feature sets to address the needs of next-generation computer users.

With support of the new Intel microarchitecture 22nm process technology, the X10DRH-C/CT/i/iT drastically increases system performance for a multitude of server applications.

The PCH C612 chip provides Enterprise SMBus support, including the following features:

- DDR4 288-pin memory support on Socket R3
- Support for MCTP Protocol
- Support for Management Engine (ME)
- Support of SMBus speeds of up to 400KHz for BMC connectivity
- Improved I/O capabilities to high-storage-capacity configurations
- SPI enhancements
- Intel® Node Manager 3.0 for advanced power monitoring, capping, and management for BMC enhancement
- The BMC supports remote management, virtualization, and the security package for enterprise platforms

 **Note:** Node Manager 3.0 support is dependent on the power supply used in the system.

## 1-3 Special Features

### Recovery from AC Power Loss

The Basic I/O System (BIOS) provides a setting that determines how the system will respond when AC power is lost and then restored to the system. You can choose for the system to remain powered off (in which case you must press the power switch to turn it back on) or for it to automatically return to the power-on state. See the Advanced BIOS Setup section for this setting. The default setting is **Last State**.

## 1-4 System Health Monitoring

This section describes the features of system health monitoring of the motherboard. This motherboard has an onboard Baseboard Management Controller (BMC) that supports system health monitoring. An onboard voltage monitor will scan the following onboard voltages continuously: 1.2V, +3.3V, 3.3V standby, +5V, +5V standby, +12V, CPU core, memory, chipset, BMC, PCH, and battery voltages. Once a voltage becomes unstable, a warning is given or an error message is sent to the screen. The user can adjust the voltage thresholds to define the sensitivity of the voltage monitor.

### Fan Status Monitor with Firmware Control

System health monitoring support provided by the BMC controller can check the RPM status of a cooling fan. The onboard CPU and chassis fans are controlled by IPMI Thermal Management.

### Environmental Temperature Control

System health sensors in the BMC monitors temperatures and voltage settings of onboard processors and the system in real time via the IPMI interface. Whenever the temperature of the CPU or the system exceeds a user-defined threshold, system/CPU cooling fans will be turned on to prevent the CPU or system from overheating.

 **Note:** To avoid possible system overheating, please be sure to provide adequate airflow to your system.

### System Resource Alert

This feature is available when used with SuperDoctor 5. SuperDoctor 5 is used to notify the user of certain system events. For example, you can configure SuperDoctor 5 to warn you when the system temperature, CPU temperatures, voltages, or fan speeds go beyond a predefined range.

## 1-5 ACPI Features

ACPI stands for *Advanced Configuration and Power Interface*. The ACPI specification defines a flexible and abstract hardware interface that provides a standard way to integrate power management features throughout a system, including its hardware, operating system, and application software. This enables the system to automatically turn on and off peripherals such as network cards, hard-disk drives, and printers.

In addition to power management directed by the operating system, the ACPI also provides a generic system event mechanism for Plug-and-Play and an interface (independent of the operating system) for configuration control. ACPI leverages the Plug-and-Play BIOS data structures, while providing an implementation that is independent of the processor architecture and compatible with Windows 8/R2 and Windows 2012/R2 Operating Systems.

## 1-6 Power Supply

As with all computer products, a stable power source is necessary for proper and reliable operation. This is even more important for processors that have high CPU clock rates.

The X10DRH-C/CT/i/iT motherboard accommodates 24-pin ATX power supplies. Although most power supplies generally meet the specifications required by the CPU, some are inadequate. In addition, two 12V 8-pin power connections are also required to ensure adequate power supply to the system.

**Warning!** To avoid damaging the power supply or the motherboard, be sure to use a power supply that contains a 24-pin and two 8-pin power connectors. Be sure to connect the power supply to the 24-pin power connector (J24) and two 8-pin power connectors (JPWR1, JPWR2) on the motherboard. Failure to do so may void the manufacturer warranty on your power supply and motherboard.

It is strongly recommended that you use a high-quality power supply that meets the ATX power supply specification 2.02 or above. It must also be SSI-compliant. (For more information, please refer to the website at <http://www.ssiforum.org/>.) Additionally, in areas where noisy power transmission is present, you may choose to install a line filter to shield the computer from noise. It is recommended that you also install a power surge protector to help avoid problems caused by power surges.

## 1-7 Advanced Power Management

The following new advanced power management features are supported by this motherboard:

### **Intel<sup>®</sup> Intelligent Power Node Manager (NM) (Available when the Supermicro Power Manager [SPM] is installed)**

The Intel<sup>®</sup> Intelligent Power Node Manager 3.0 (IPNM) provides your system with real-time thermal control and power management for maximum energy efficiency. Although IPNM Specification Version 2.0/3.0 is supported by the BMC (Baseboard Management Controller), your system must also have IPNM-compatible Management Engine (ME) firmware installed to use this feature.

 **Note:** Support for IPNM Specification Version 2.0 or Version 3.0 is dependent on the power supply used in the system.

### **Management Engine (ME)**

The Management Engine, which is an ARC controller embedded in the PCH, provides Server Platform Services (SPS) to your system. The services provided by SPS are different from those provided by the ME on client platforms.

## Chapter 2

### Installation

#### 2-1 Standardized Warning Statements

The following statements are industry-standard warnings, provided to warn the user of situations which have the potential for bodily injury. Should you have questions or experience difficulty, contact Supermicro's Technical Support Department for assistance. Only certified technicians should attempt to install or configure components. Read this section in its entirety before installing or configuring components in the Supermicro chassis.

#### Battery Handling



**Warning!**

There is a danger of explosion if the battery is replaced incorrectly. Replace the battery only with the same or an equivalent type recommended by the manufacturer. Dispose of used batteries according to the manufacturer's instructions.

Warnung

Bei Einsetzen einer falschen Batterie besteht Explosionsgefahr. Ersetzen Sie die Batterie nur durch den gleichen oder vom Hersteller empfohlenen Batterietyp. Entsorgen Sie die benutzten Batterien nach den Anweisungen des Herstellers.

Attention

Danger d'explosion si la pile n'est pas remplacée correctement. Ne la remplacer que par une pile de type semblable ou équivalent, recommandée par le fabricant. Jeter les piles usagées conformément aux instructions du fabricant.

¡Advertencia!

Existe peligro de explosión si la batería se reemplaza de manera incorrecta. Reemplazar la batería exclusivamente con el mismo tipo o el equivalente recomendado por el fabricante. Desechar las baterías gastadas según las instrucciones del fabricante.

**אזהרה !**

קיימת סכנת פיצוץ של הסוללה במידה והוחלפה בדרך לא תקינה. יש להחליף את הסוללה בסוג התואם מחברת יצרן מומלצת.

סילוק הסוללות המשומשות יש לבצע לפי הוראות היצרן.

هناك خطر من التيار الكهربائي أو الطاقة الموجودة على اللوحة عندما يكون النظام يعمل كن حذرا عند خدمة هذا الجهاز

경고!

배터리가 올바르게 교체되지 않으면 폭발의 위험이 있습니다. 기존 배터리와 동일하거나 제조사에서 권장하는 동등한 종류의 배터리로만 교체해야 합니다. 제조사의 안내에 따라 사용된 배터리를 처리하여 주십시오.

Waarschuwing

Er is ontploffingsgevaar indien de batterij verkeerd vervangen wordt. Vervang de batterij slechts met hetzelfde of een equivalent type die door de fabrikant aanbevolen wordt. Gebruikte batterijen dienen overeenkomstig fabrieksvoorschriften afgevoerd te worden.



תורת המורה

Warnung  
 Die Entsorgung dieses Produkts sollte gemäß allen Bestimmungen und Gesetzen des Landes erfolgen.  
 !Advertencia!  
 Al deshacerse por completo de este producto debe seguir todas las leyes y reglamentos nacionales.  
 Attention  
 La mise au rebut ou le recyclage de ce produit sont généralement soumis à des lois et/ou directives de respect de l'environnement. Renseignez-vous auprès de l'organisme compétent.

この製品を廃棄処分する場合、国の関係する全ての法律・条例に従い処理する必要があります。

製品の廃棄

Warning!  
 Ultimate disposal of this product should be handled according to all national laws and regulations.



**Product Disposal**

عند التخلص النهائي من هذا المنتج ينبغي التعامل معه وفقا لجميع القوانين واللوائح الوطنية

경고!

이 제품은 해당 국가의 관련 법규 및 규정에 따라 폐기되어야 합니다.

Waarschuwing

De uiteindelijke verwijdering van dit product dient te geschieden in overeenstemming met alle nationale wetten en reglementen.

## 2-2 Static-Sensitive Devices

Electrostatic Discharge (ESD) can damage electronic components. To avoid damaging your system board, it is important to handle it very carefully. The following measures are generally sufficient to protect your equipment from ESD.

### Precautions

- Use a grounded wrist strap designed to prevent static discharge.
- Touch a grounded metal object before removing the board from the antistatic bag.
- Handle the motherboard by its edges only; do not touch its components, peripheral chips, memory modules, or gold contacts.
- When handling chips or modules, avoid touching their pins.
- Put the motherboard and peripherals back into their antistatic bags when not in use.
- For grounding purposes, make sure that your system chassis provides excellent conductivity between the power supply, case, mounting fasteners, and the motherboard.

### Unpacking

The motherboard is shipped in antistatic packaging to avoid static damage. When unpacking the motherboard, make sure that the person handling it is static-protected.

## 2-3 Motherboard Installation

All motherboards have standard mounting holes to fit different types of chassis. Make sure that the locations of all mounting holes for both motherboard and chassis match. Although a chassis may have both plastic and metal mounting fasteners, metal ones are recommended because they ground the motherboard to the chassis. Make sure that the metal standoffs click in or are screwed in tightly. Then use a screwdriver to secure the motherboard onto the motherboard tray.

### Tools Needed

- Phillips screwdriver
- Panhead screws (9 pieces)
- Standoffs (9 pieces, if needed)

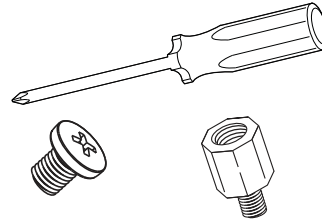

### Location of Mounting Holes

There are nine (9) mounting holes on this motherboard as indicated by the arrows.

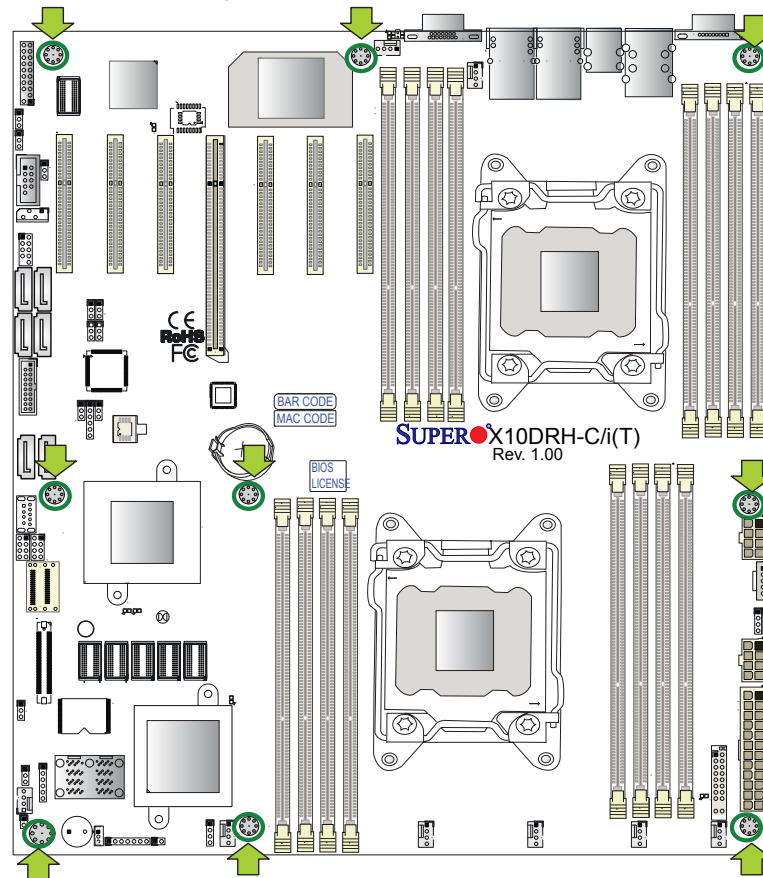

**Caution:** 1) To avoid damaging the motherboard and its components, do not use a force greater than 8 lb/inch on each mounting screw during motherboard installation. 2) Some components are very close to the mounting holes. Please use caution to prevent damage to these components when installing the motherboard to the chassis.

## Installing the Motherboard

 **Note:** Always connect the power cord last, and always remove it before adding, removing, or changing any hardware components.

1. Install the I/O shield into the chassis.

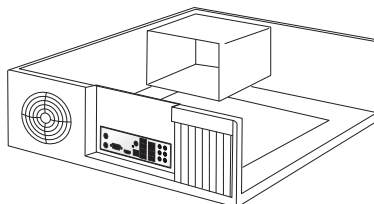

2. Locate the mounting holes on the motherboard.
3. Locate the matching mounting holes on the chassis. Align the mounting holes on the motherboard against the mounting holes on the chassis.
4. Install standoffs in the chassis if needed.

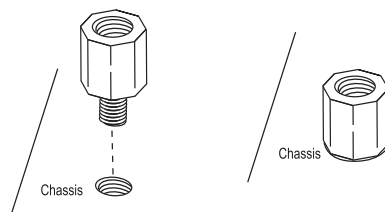

5. Install the motherboard into the chassis carefully to avoid damaging motherboard components.
6. Using the Phillips screwdriver, insert a panhead #6 screw into a mounting hole on the motherboard and its matching mounting hole on the chassis.

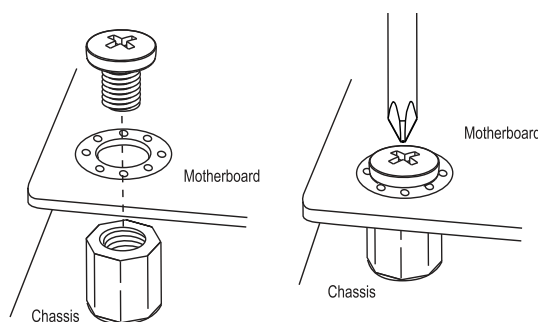

7. Repeat Step 5 to insert #6 screws into all mounting holes.
8. Make sure that the motherboard is securely placed in the chassis.

 **Note:** Images displayed are for illustration only. Your chassis or components might look different from those shown in this manual.

## 2-4 Processor and Heatsink Installation

**Warning:** When handling the processor package, avoid placing direct pressure on the label area. Also, improper CPU installation and socket/pin misalignment may cause serious damage to the CPU or the motherboard that will require RMA repairs. Be sure to read and follow all instructions thoroughly before installing your CPU and heatsink.

 **Notes:**

- Always connect the power cord last, and always remove it before adding, removing, or changing any hardware components. Make sure that you install the processor into the CPU socket before you install the CPU heatsink.
- If you buy a CPU separately, make sure that you use an Intel-certified multidirectional heatsink only.
- Make sure to install the motherboard into the chassis before you install the CPU heatsink.
- If you receive a motherboard without a processor preinstalled, make sure that the plastic CPU socket cap is in place and that none of the socket pins are bent; otherwise, contact your retailer immediately.

### Installing the LGA2011 Processor

1. There are two load levers on the LGA2011 socket. To open the socket cover, first press and release the load lever labeled "Open 1st."

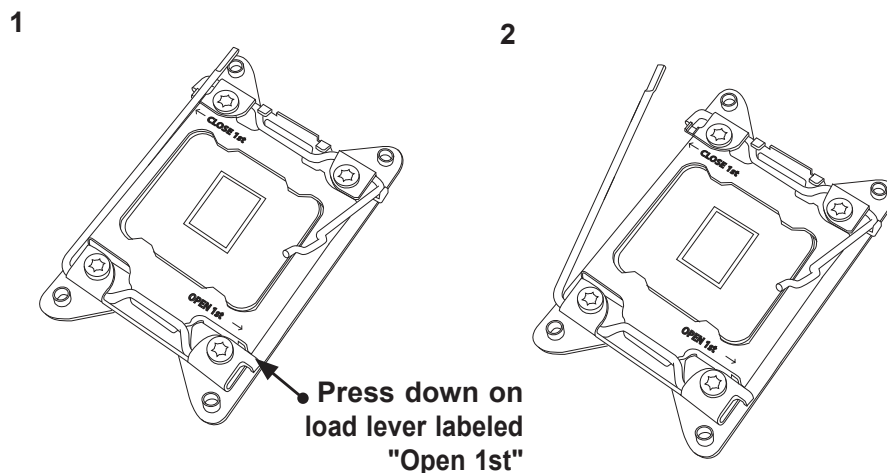

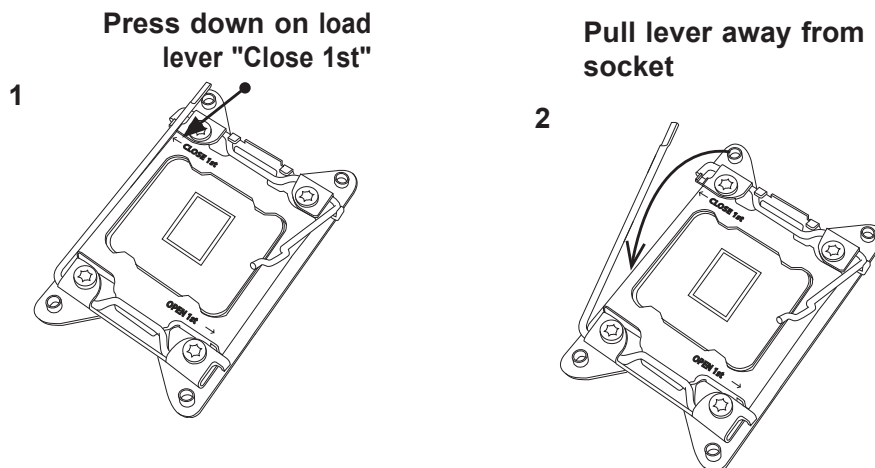

 **Note:** All graphics, drawings, and pictures shown in this manual are for illustration only. The components that came with your machine may or may not look exactly the same as those shown in this manual.

2. Press the second load lever labeled "Close 1st" to release the load plate that covers the CPU socket from its locking position.

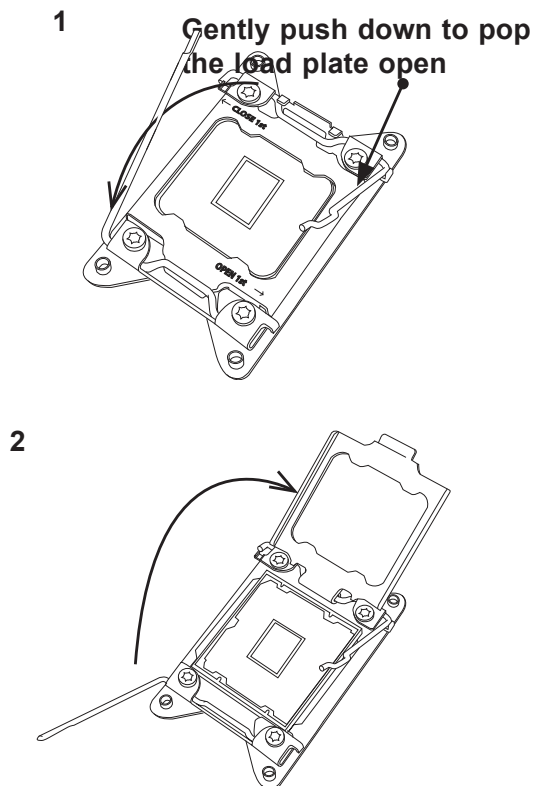

3. With the lever labeled "Close 1st" fully retracted, gently push down on the lever labeled "Open 1st" to open the load plate. Lift the load plate to open it completely.



 **Note:** All graphics, drawings and pictures shown in this manual are for illustration only. The components that came with your machine may or may not look exactly the same as those shown in this manual.

- Use your thumb and index finger to loosen the lever and open the load plate.

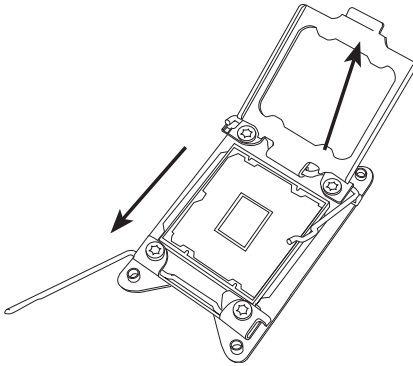

- Using your thumb and index finger, hold the CPU by its edges. Align the CPU keys, which are semicircle notches, against the socket keys.

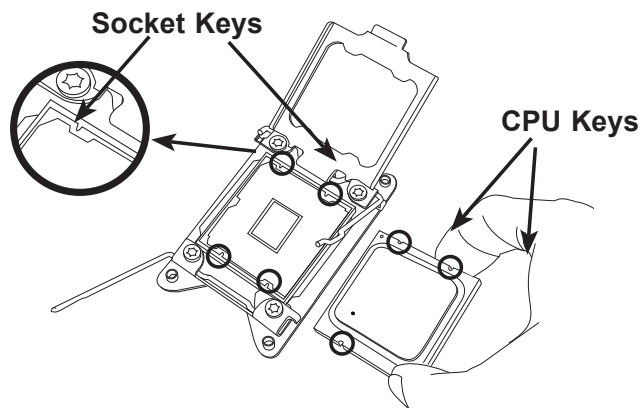

- Once they are aligned, carefully lower the CPU straight down into the socket. Do not drop the CPU on the socket or move the CPU horizontally or vertically. Do not rub the CPU against the surface or against any of the socket pins to avoid damaging the CPU or the socket.

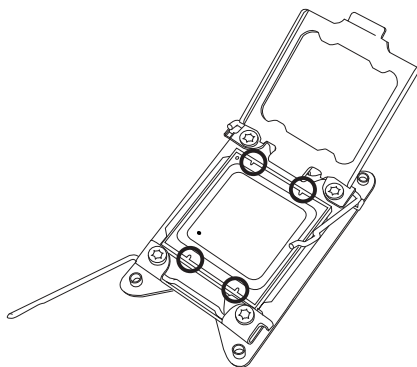

**Warning:** You can only install the CPU inside the socket in one direction. Make sure that it is properly inserted into the CPU socket before closing the load plate. If it doesn't close properly, do not force it as this may damage your CPU. Instead, open the load plate again to make sure that the CPU is aligned properly.

7. With the CPU inside the socket, inspect the four corners of the CPU to make sure that the CPU is properly installed.

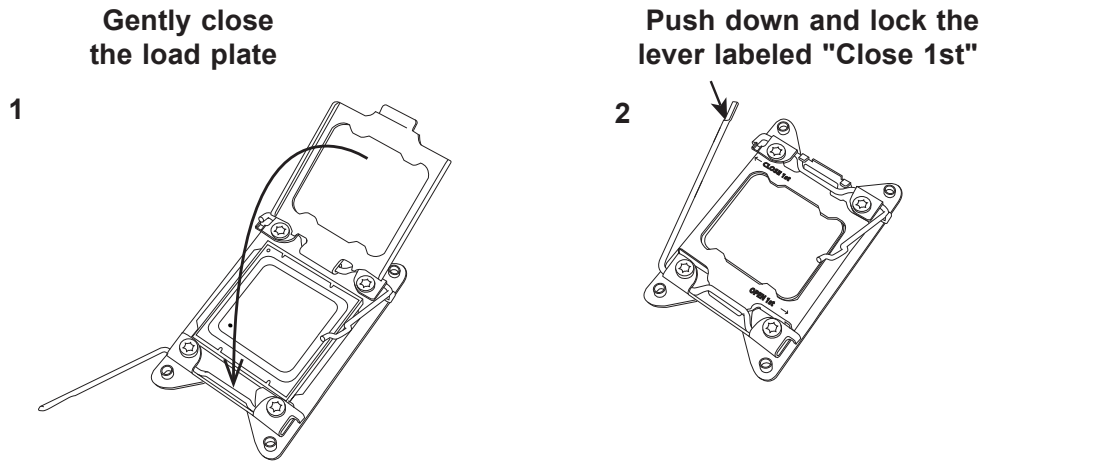

8. Close the load plate with the CPU inside the socket. Lock the lever labeled "Close 1st" first, then lock the lever labeled "Open 1st" second. Using your thumb, gently push the load levers down to the lever locks.

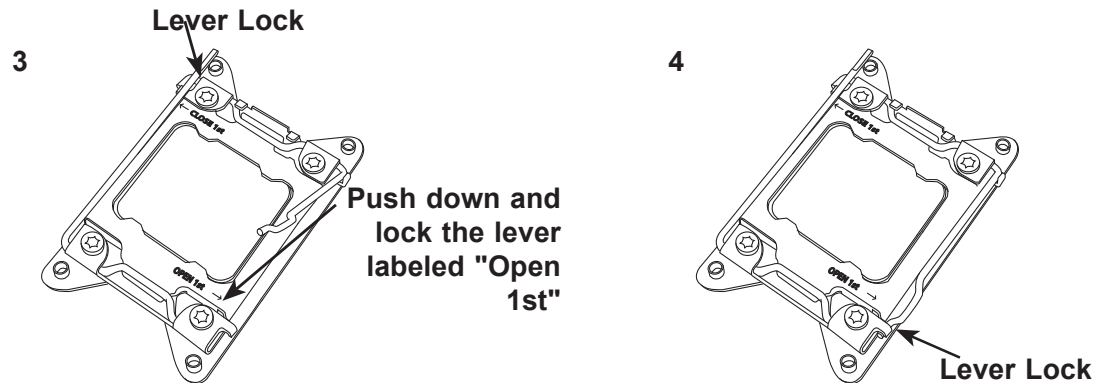



## Installing a Passive CPU Heatsink

1. Do not apply any thermal grease to the heatsink or the CPU die -- the required amount has already been applied.
2. Place the heatsink on top of the CPU so that the four mounting holes are aligned with those on the motherboard and the heatsink bracket underneath.
3. Screw in two diagonal screws (e.g., the #1 and the #2 screws) until just snug. Do not over-tighten the screws to avoid damaging the CPU and the motherboard.
4. Finish the installation by fully tightening all four screws.

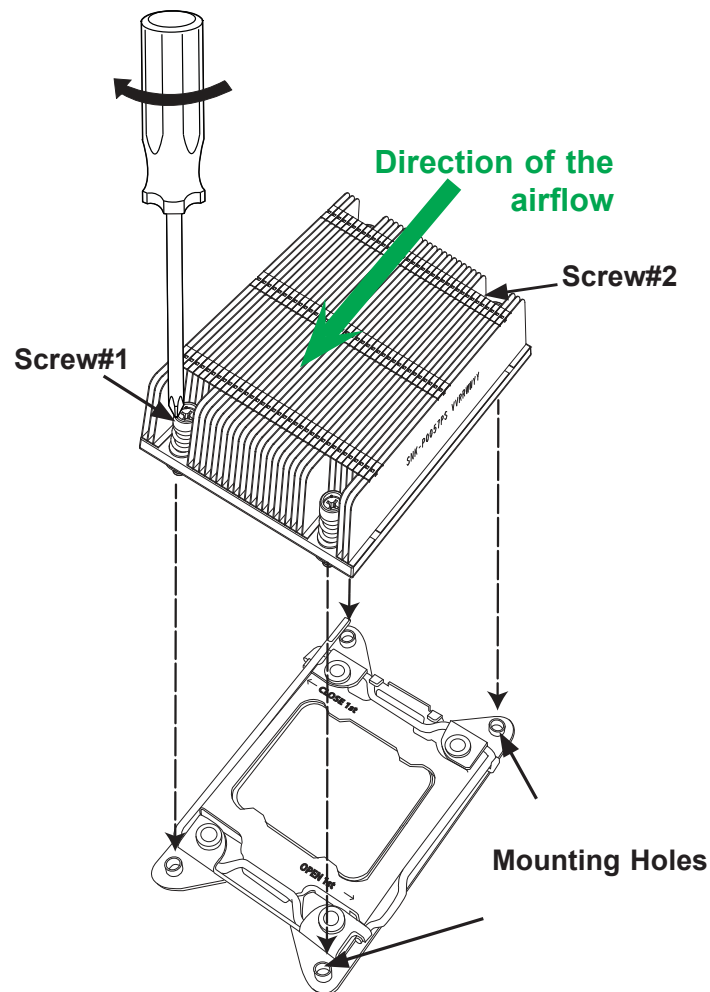



 **Note:** For optimal airflow, please follow your chassis airflow direction to correctly install the CPU heatsink. Graphic drawings included in this manual are for reference only. They might look different from the components installed in your system.

## Removing the CPU and the Heatsink

**Warning:** We do not recommend that the CPU or the heatsink be removed. However, if you do need to uninstall the CPU or the heatsink, please follow the instructions below to uninstall the heatsink to avoid damaging the CPU or the motherboard.

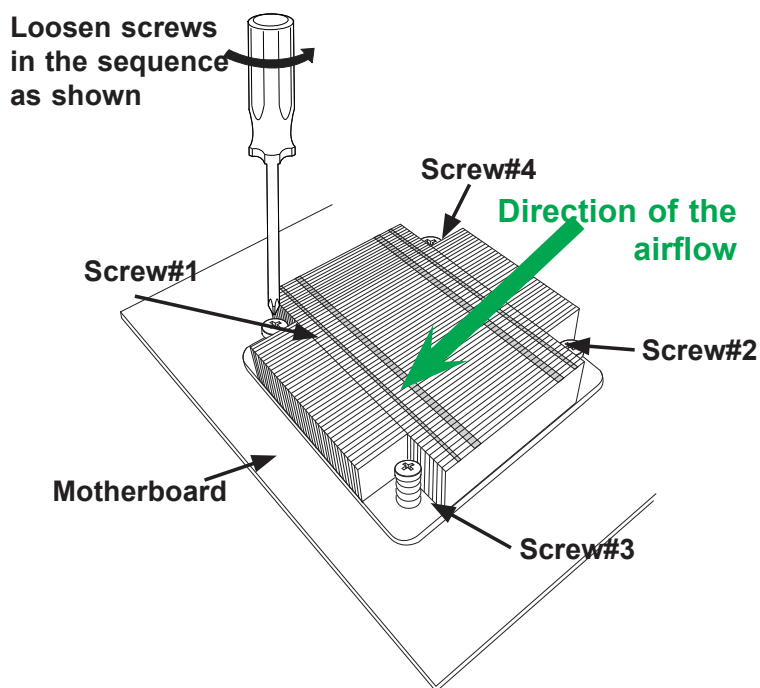
1. Unscrew the heatsink screws from the motherboard in the sequence as shown in the illustration below.
2. Gently wriggle the heatsink to loosen it from the CPU. Do not use excessive force when loosening the heatsink!
3. Once the heatsink is loosened from the socket, remove the heatsink from the CPU socket. Once the heatsink is removed, remove the CPU from the socket as needed.
4. Remove the used thermal grease and clean the surface of the CPU and the heatsink. Reapply the proper amount of thermal grease on the surface before reinstalling the CPU and the heatsink as needed.



 **Notes:** 1.) For optimized airflow, please follow your chassis airflow direction to properly install the heatsink. 2.) Graphics shown in this manual are for reference only. They may or may not look the same as the components installed in your system.

## 2-5 Installing and Removing the Memory Modules

**Note:** Check Supermicro's website for a list of recommended memory modules.

### CAUTION

Exercise extreme care when installing or removing DIMM modules to avoid damaging the DIMM modules or the motherboard.

### Installing & Removing DIMMs

1. Insert the desired number of DIMMs into the memory slots, starting with P1-DIMMA1. For best performance, please use DIMM modules of the same type and speed in the same bank.
2. Push the release tabs outwards on both ends of the DIMM slot to unlock it.

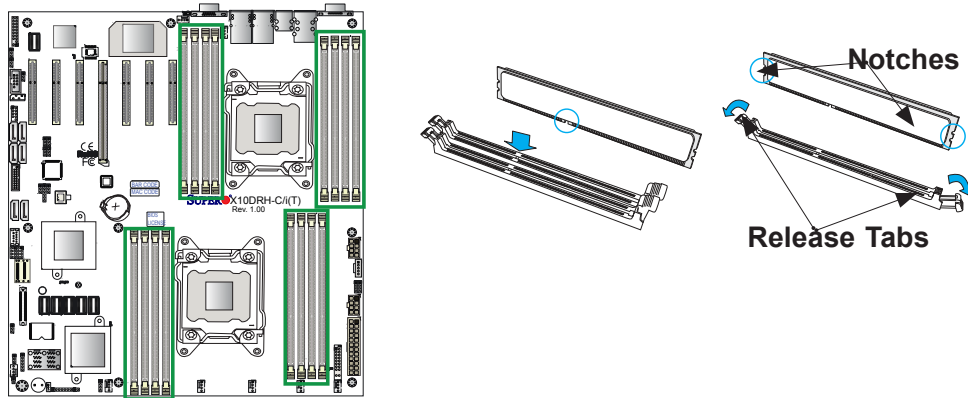

3. Align the key of the DIMM module with the receptive point on the memory slot.
4. Align the notches on both ends of the module against the receptive points at each side of the slot.
5. With your thumbs, press the notches on both ends of the module straight down into the slot until the module snaps into place.
6. Press the release tabs to their locking positions to secure the DIMM into the slot.

Press both notches straight down into the memory slot at the same time.

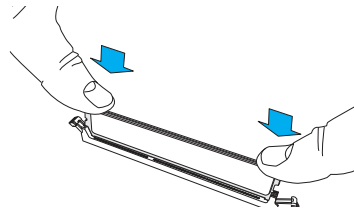

### Removing Memory Modules

Press both release tabs on the ends of the DIMM to unlock it. Once the DIMM is loosened, remove it from the memory slot.

### Memory Support for the X10DRH-C/CT/i/iT Motherboard

The X10DRH-C/CT/i/iT motherboard supports up to 1024 GB of Load Reduced (LRDIMM) or 512 GB of Registered (RDIMM) DDR4 (288-pin) ECC 2133/1866 MHz modules in 16 slots. Memory speed support depends on the CPUs installed in the motherboard. For the latest memory updates, please refer to our website at <http://www.supermicro.com/products/motherboard>.

### Processor & Memory Module Population Configuration

For the memory to work properly, follow the tables below for memory installation.

| Processors and their Corresponding Memory Modules |                            |           |           |           |           |            |           |           |
|---------------------------------------------------|----------------------------|-----------|-----------|-----------|-----------|------------|-----------|-----------|
| CPU#                                              | Corresponding DIMM Modules |           |           |           |           |            |           |           |
| <b>CPU 1</b>                                      | P1-DIMMA1                  | P1-DIMMB1 | P1-DIMMC1 | P1-DIMMD1 | P1-DIMMA2 | P1-DIMMB2  | P1-DIMMC2 | P1-DIMMD2 |
| <b>CPU2</b>                                       | P2-DIMME1                  | P2-DIMMF1 | P2-DIMMG1 | P2-DIMMH1 | P2-DIMME2 | P2-DIMM F2 | P2-DIMMG2 | P2-DIMMH2 |

| Processor and Memory Module Population for Optimal Performance |                                                                                                                                                                                 |
|----------------------------------------------------------------|---------------------------------------------------------------------------------------------------------------------------------------------------------------------------------|
| Number of CPUs+DIMMs                                           | CPU and Memory Population Configuration Table<br>(For memory to work properly, please follow this table.)                                                                       |
| <b>1 CPU &amp; 2 DIMMs</b>                                     | CPU1<br>P1-DIMMA1/P1-DIMMB1                                                                                                                                                     |
| <b>1 CPU &amp; 4 DIMMs</b>                                     | CPU1<br>P1-DIMMA1/P1-DIMMB1, P1-DIMMC1/P1-DIMMD1                                                                                                                                |
| <b>1 CPU &amp; 6~8 DIMMs</b>                                   | CPU1<br>P1-DIMMA1/P1-DIMMB1, P1-DIMMC1/P1-DIMMD1 + any pair of P1-DIMMA2/P1-DIMMB2/P1-DIMMC2/P1-DIMMD2 slots                                                                    |
| <b>2 CPUs &amp; 4 DIMMs</b>                                    | CPU1 + CPU2<br>P1-DIMMA1/P1-DIMMB1, P2-DIMME1/P2-DIMMF1                                                                                                                         |
| <b>2 CPUs &amp; 6 DIMMs</b>                                    | CPU1 + CPU2<br>P1-DIMMA1/P1-DIMMB1/P1-DIMMC1/P1-DIMMD1, P2-DIMME1/P2-DIMMF1                                                                                                     |
| <b>2 CPUs &amp; 8 DIMMs</b>                                    | CPU1 + CPU2<br>P1-DIMMA1/P1-DIMMB1/P1-DIMMC1/P1-DIMMD1, P2-DIMME1/P2-DIMMF1/P2-DIMMG1/P2-DIMMH1                                                                                 |
| <b>2 CPUs &amp; 10~16 DIMMs</b>                                | CPU1/CPU2<br>P1-DIMMA1/P1-DIMMB1/P1-DIMMC1/P1-DIMMD1, P2-DIMME1/P2-DIMMF1/P2-DIMMG1/P2-DIMMH1 + any pair of P1, P2 DIMM slots                                                   |
| <b>2 CPUs &amp; 16 DIMMs</b>                                   | CPU1/CPU2<br>P1-DIMMA1/P1-DIMMB1/P1-DIMMC1/P1-DIMMD1, P2-DIMME1/P2-DIMMF1/P2-DIMMG1/P2-DIMMH1, P1-DIMMA2/P1-DIMMB2/P1-DIMMC2/P1-DIMMD2, P2-DIMME2/P2-DIMMF2/P2-DIMMG2/P2-DIMMH2 |

## Populating RDIMM/LRDIMM ECC Memory Modules

### Intel E5-2600 v3 Series Processor Memory Support

| Type            | Ranks Per DIMM and Data Width | DIMM Capacity (GB) |       | Speed (MT/s); Voltage (V); Slot Per Channel (SPC) and DIMM Per Channel (DPC) |                     |      |
|-----------------|-------------------------------|--------------------|-------|------------------------------------------------------------------------------|---------------------|------|
|                 |                               |                    |       | 1 Slot Per Channel                                                           | 2 Slots Per Channel |      |
|                 |                               | 4Gb                | 8Gb   | 1DPC                                                                         | 1DPC                | 2DPC |
|                 |                               |                    |       | 1.2V                                                                         | 1.2V                | 1.2V |
| RDIMM           | SRx4                          | 8GB                | 16GB  | 2133                                                                         | 2133                | 1866 |
| RDIMM           | SRx8                          | 4GB                | 8GB   | 2133                                                                         | 2133                | 1866 |
| RDIMM           | DRx8                          | 8GB                | 16GB  | 2133                                                                         | 2133                | 1866 |
| RDIMM           | DRx4                          | 16GB               | 32GB  | 2133                                                                         | 2133                | 1866 |
| LRDIMM          | QRx4                          | 32GB               | 64GB  | 2133                                                                         | 2133                | 2133 |
| LRDIMM †<br>3DS | 8Rx4                          | 64GB               | 128GB | 2133                                                                         | 2133                | 2133 |

## Populating RDIMM/LRDIMM ECC Memory Modules

### Intel E5-2600 v4 Series Processor Memory Support

| Type          | Ranks Per DIMM and Data Width | DIMM Capacity (GB) |       | Speed (MT/s); Voltage (V); Slot Per Channel (SPC) and DIMM Per Channel (DPC) |                     |      |
|---------------|-------------------------------|--------------------|-------|------------------------------------------------------------------------------|---------------------|------|
|               |                               |                    |       | 1 Slot Per Channel                                                           | 2 Slots Per Channel |      |
|               |                               | 4Gb                | 8Gb   | 1DPC                                                                         | 1DPC                | 2DPC |
|               |                               |                    |       | 1.2V                                                                         | 1.2V                | 1.2V |
| RDIMM         | SRx4                          | 8GB                | 16GB  | 2400                                                                         | 2400                | 2133 |
| RDIMM         | SRx8                          | 4GB                | 8GB   | 2400                                                                         | 2400                | 2133 |
| RDIMM         | DRx8                          | 8GB                | 16GB  | 2400                                                                         | 2400                | 2133 |
| RDIMM         | DRx4                          | 16GB               | 32GB  | 2400                                                                         | 2400                | 2133 |
| LRDIMM        | QRx4                          | 32GB               | 64GB  | 2400                                                                         | 2400                | 2400 |
| LRDIMM<br>3DS | 8Rx4                          | 64GB               | 128GB | 2400                                                                         | 2400                | 2400 |

## 2-6 Onboard 3108 SAS Controller with CacheVault Support (Optional for X10DRH-C/CT)

A CacheVault header, marked as 'TFM' on the X10DRH-C/CT motherboard layout, supports the Supermicro 3108 CacheVault kit. Please purchase an optional 3108 CacheVault kit from Supermicro and connect it to the onboard CacheVault (TFM) header (as shown in the layout below) to help enhance system performance and data protection during a power outage.

### The 3108 CacheVault Kit (Optional)

The 3108 CacheVault kit contains the following:

1. One (1) CVFM04 (8GB CacheVault Flash Module)
2. One (1) CVPM02 (CacheVault Power Module)
3. One (1) L3-000099-00 (23" Cable Extender)

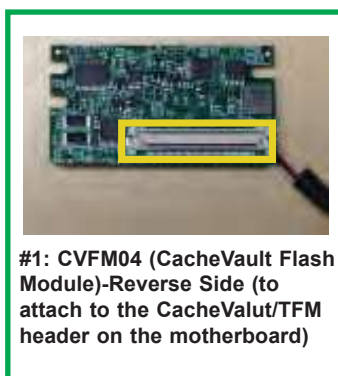
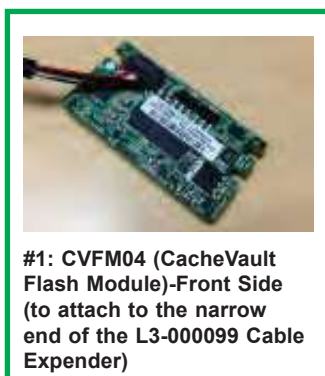
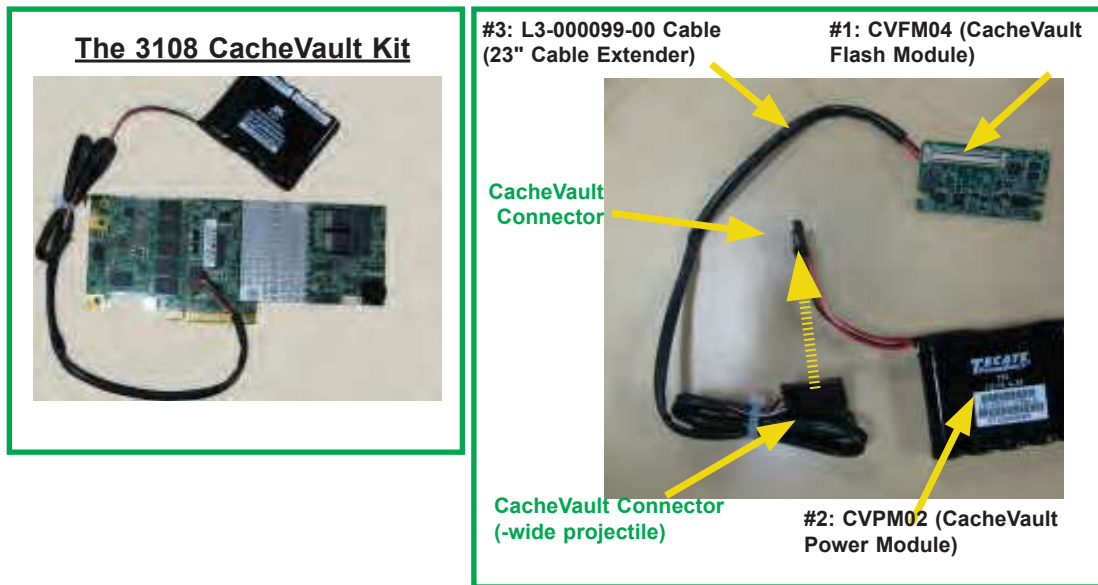
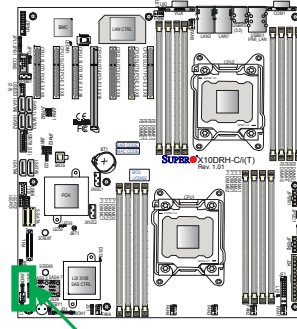

## Installing the 3108 CacheVault Kit

1. Connect the narrow connector (#1) on one end of the L3-000099-00 Cable Expender to the CacheVault/TFM connector (#2) on the front side of the CacheVault Flash Module as shown on the first two pictures below.

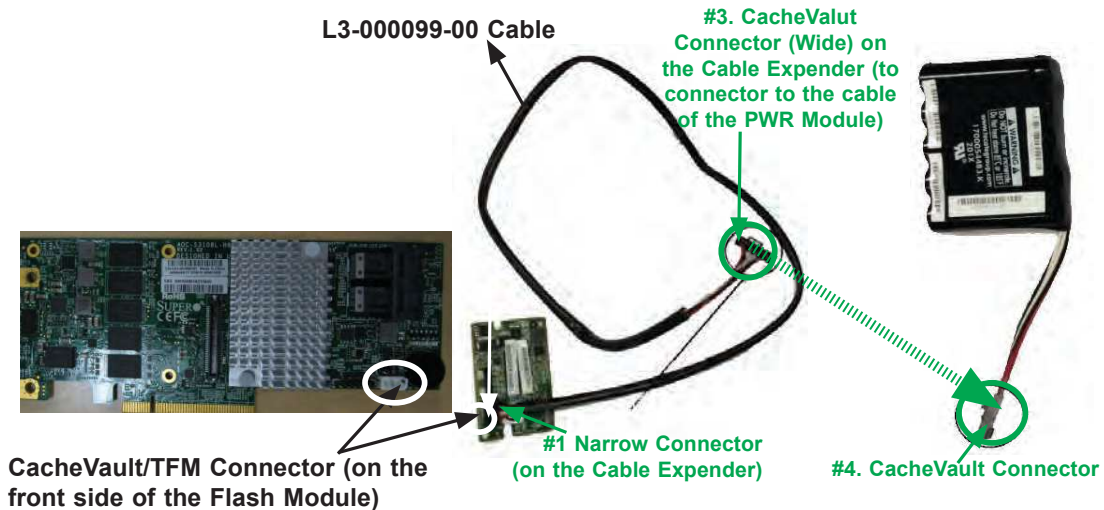

2. Connect the wide CacheVault/TFM connector (#3) on the L3-000099-00 Cable Expender to the CacheVault connector (#4) on the end of the cable attached to the Power Module as shown on the third picture above.
3. Connect the CacheVault/TFM connector located on the reverse side of the Flash Module to the CacheVault/TFM header on the motherboard as shown below.

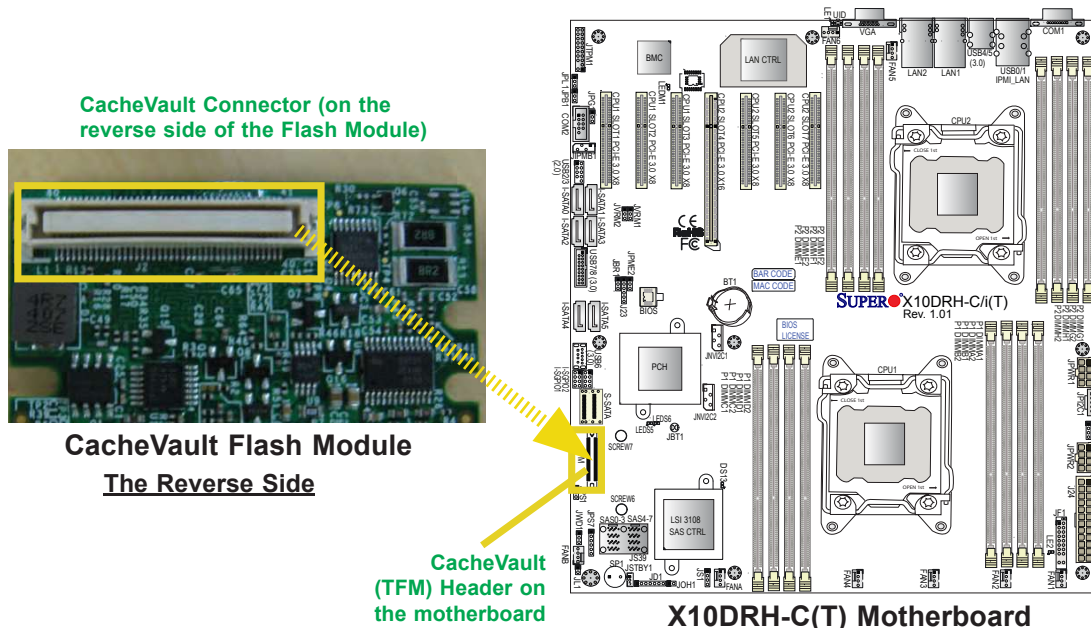

## 2-7 Control Panel Connectors and I/O Ports

The I/O ports are color-coded in conformance with the industry standards. See the picture below for the colors and locations of the various I/O ports.

### Back Panel Connectors and I/O Ports

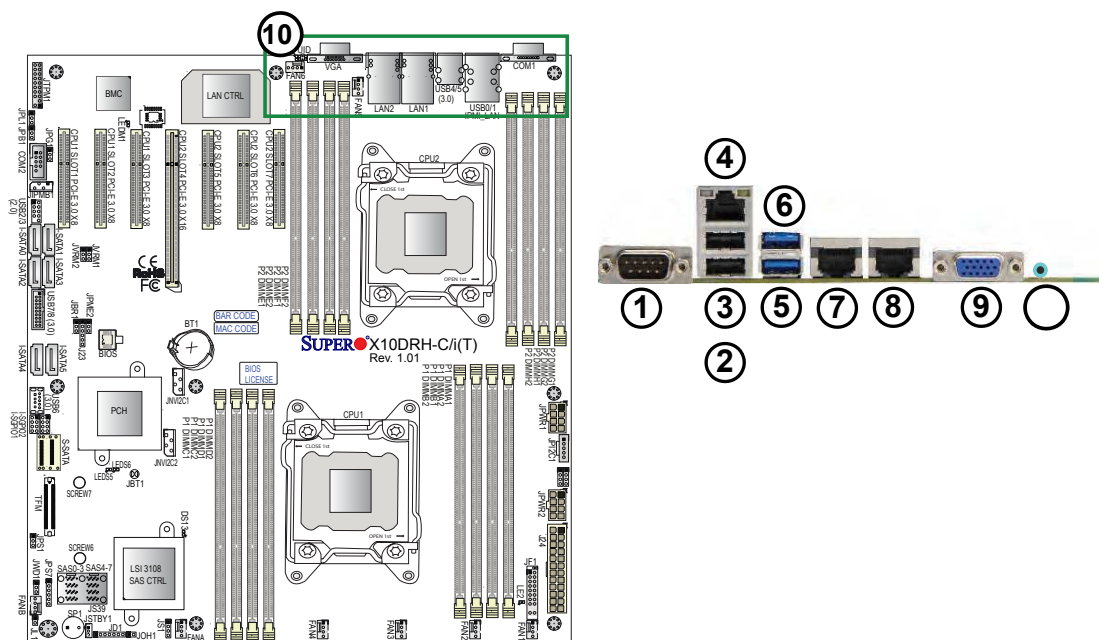

### Back Panel I/O Port Locations and Definitions

|                                                               |
|---------------------------------------------------------------|
| 1. COM Port 1                                                 |
| 2. Back Panel USB 2.0 Port 0                                  |
| 3. Back Panel USB 2.0 Port 1                                  |
| 4. IPMI-Dedicated LAN                                         |
| 5. Back Panel USB 3.0 Port 4                                  |
| 6. Back Panel USB 3.0 Port 5                                  |
| 7. Gigabit LAN 1 (X10DRH-C/i),<br>(10G) TLAN 1 (X10DRH-CT/iT) |
| 8. Gigabit LAN 2 (X10DRH-C/i),<br>(10G) TLAN 2 (X10DRH-CT/iT) |
| 9. Back Panel VGA (Blue)                                      |
| 10. UID Button/UID LED (LE1)                                  |



## Serial Ports

Two COM connections (COM1 and COM2) are located on the motherboard. COM1 is located on the I/O back panel. COM2, located next to CPU1 PCI-E Slot1, provides front access support. Refer to the board layout below for its location.

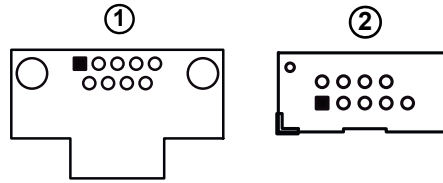

## Video Connection

A Video (VGA) port is located next to LAN2 on the I/O back panel. Refer to the board layout below for its location.

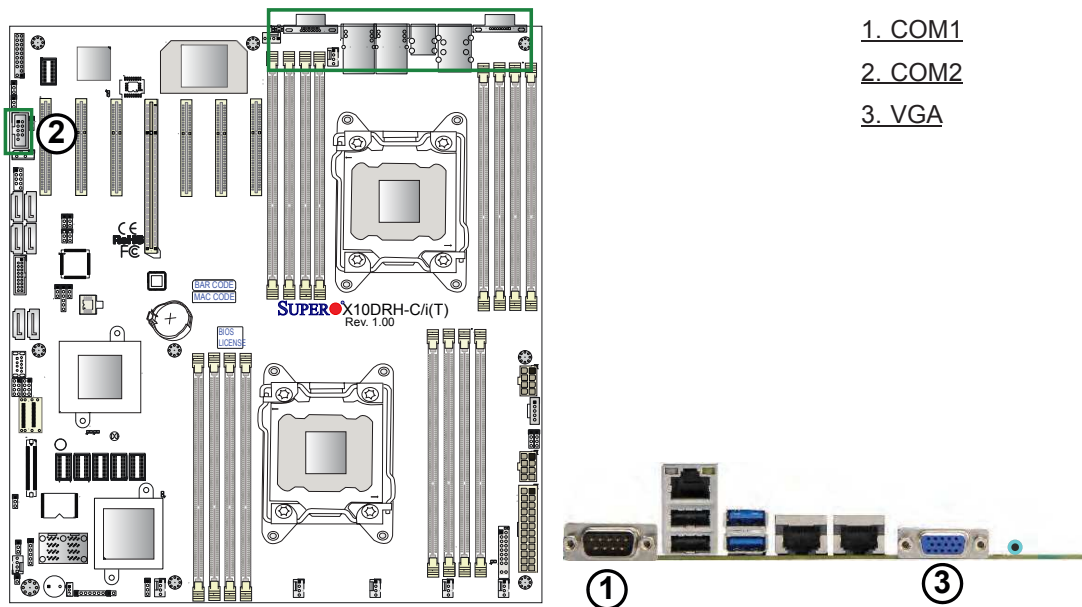

### Universal Serial Bus (USB)

Two USB 2.0 ports (USB 0/1) and two USB 3.0 ports (USB 4/5) are located on the I/O back panel. In addition, an internal USB 2.0 header and a USB 3.0 header provide support for two USB 2.0 ports (USB 2/3) and two USB 3.0 ports (USB 7/8) in the front. A Type-A connector is also located on the motherboard to provide front-panel USB 3.0 support (USB 6). (Cables are not included.) See the tables on the right and below for pin definitions.

| Back Panel USB 0/1 (2.0)<br>Pin Definitions |            |      |            |
|---------------------------------------------|------------|------|------------|
| Pin#                                        | Definition | Pin# | Definition |
| 1                                           | +5V        | 5    | +5V        |
| 2                                           | USB_PN1    | 6    | USB_PN0    |
| 3                                           | USB_PP1    | 7    | USB_PP0    |
| 4                                           | Ground     | 8    | Ground     |

| Front Panel USB 2/3 (2.0)<br>Pin Definitions |            |       |            |
|----------------------------------------------|------------|-------|------------|
| Pin #                                        | Definition | Pin # | Definition |
| 1                                            | +5V        | 2     | +5V        |
| 3                                            | USB_PN2    | 4     | USB_PN3    |
| 5                                            | USB_PP2    | 6     | USB_PP3    |
| 7                                            | Ground     | 8     | Ground     |
| 9                                            | Key        | 10    | Ground     |

| Back Panel USB 4/5 (3.0), Front Panel USB 7/8 (3.0), Type A USB 6 (3.0)<br>Pin Definitions |             |
|--------------------------------------------------------------------------------------------|-------------|
| Pin#                                                                                       | Description |
| 1                                                                                          | VBUS        |
| 2                                                                                          | SSRX-       |
| 3                                                                                          | SSRX+       |
| 4                                                                                          | Ground      |
| 5                                                                                          | SSTX-       |
| 6                                                                                          | SSTX+       |
| 7                                                                                          | GND_DRAIN   |
| 8                                                                                          | D-          |
| 9                                                                                          | D+          |

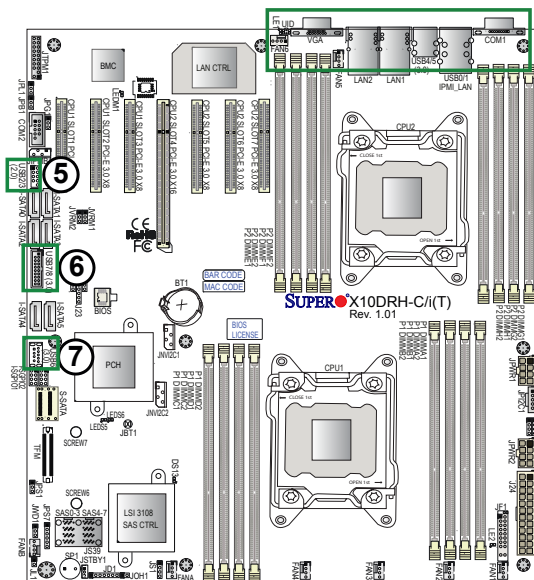

1. Back Panel USB0 (USB2.0)
2. Back Panel USB1 (USB2.0)
3. Back Panel USB4 (USB3.0)
4. Back Panel USB5 (USB3.0)
5. Front Panel USB 2/3 (USB2.0)
6. Front Panel USB 7/8 (USB3.0)
7. Type-A USB 6 (USB3.0)

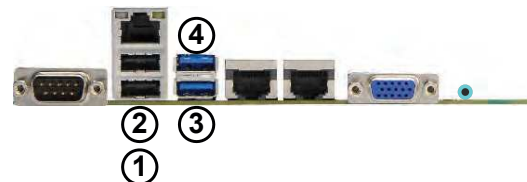

## Ethernet Ports

Two Gigabit Ethernet ports (LAN1 and LAN2) are located on the I/O back panel on the motherboard. These Ethernet ports support 1GbE LANs on the X10DRH-C/i and 10GbE LANs on the X10DRH-CT/iT. In addition, an IPMI-dedicated LAN is located above USB 0/1 ports on the back panel. All of these ports accept RJ45 cables. Please refer to the LED Indicator section for LAN LED information.

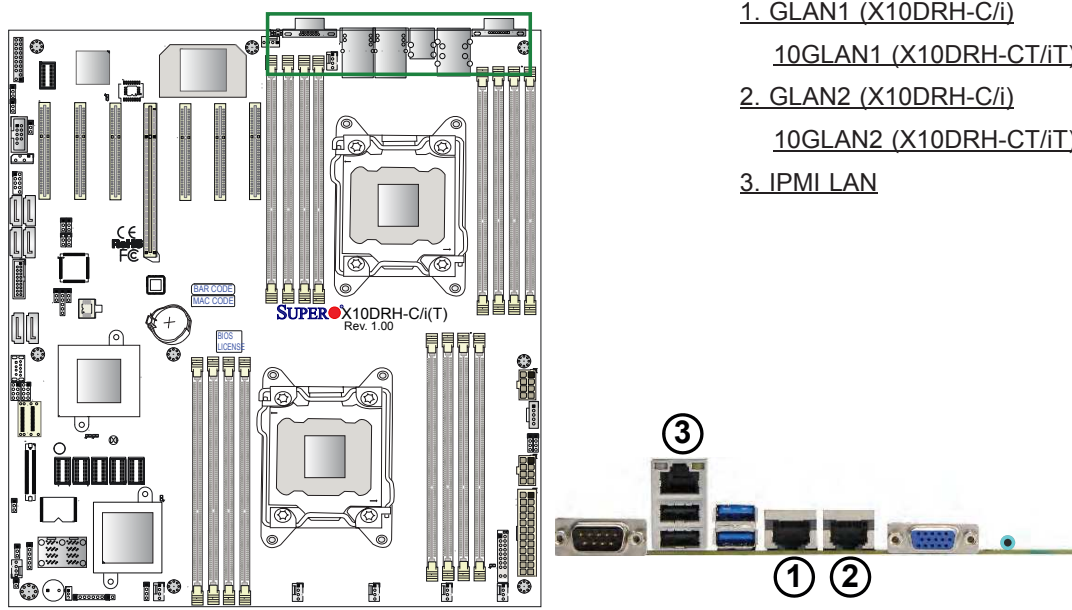

### Unit Identifier Switches/UID LED Indicators

A rear Unit Identifier (UID) switch and a rear UID LED (LE1) are located next to the VGA port on the motherboard. The front UID switch and the UID LED are both located on the front panel control (JF1), with the front UID switch on pin 13 of JF1 and the front UID LED on pin 7. When you press either the front or rear UID switch, both front and rear UID LEDs will be turned on. Press the UID switch again to turn off the LED indicators. The UID indicators provide easy identification of a system unit that may be in need of service.

 **Note:** UID can also be triggered via IPMI on the motherboard. For more information on IPMI, please refer to the IPMI user's guide posted on our website at <http://www.supernmicro.com>.

| UID Switch |            |
|------------|------------|
| Pin#       | Definition |
| 1          | Ground     |
| 2          | Ground     |
| 3          | Button In  |
| 4          | Ground     |

| UID LED Status |                 |
|----------------|-----------------|
| Color/State    | Status          |
| Blue: On       | Unit Identified |

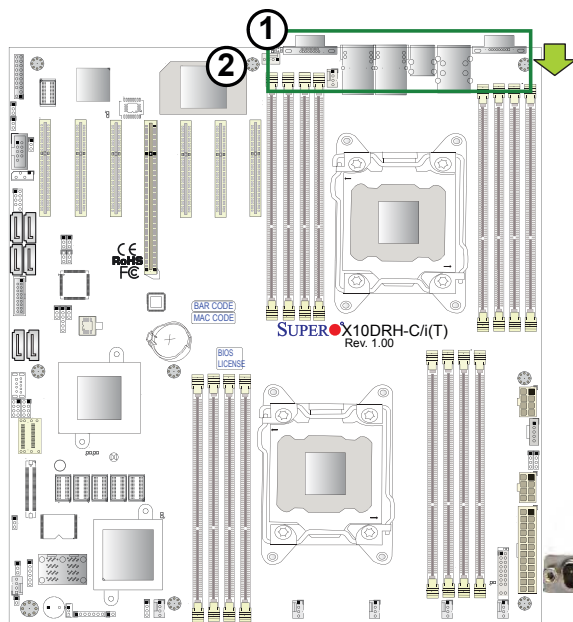
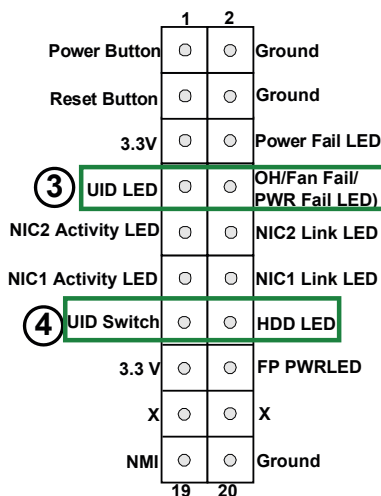

- 1. UID Switch
- 2. Rear UID LED
- 3. Front UID LED (on pin 7 of JF1)
- 4. Front UID Switch (on pin 13 of JF1)

## Front Control Panel

JF1 contains header pins for various buttons and indicators that are normally located on a control panel at the front of the chassis. These connectors are designed specifically for use with Supermicro's server chassis. See the figure below for the descriptions of the various control panel buttons and LED indicators. Refer to the following section for descriptions and pin definitions.

JF1 Header Pins

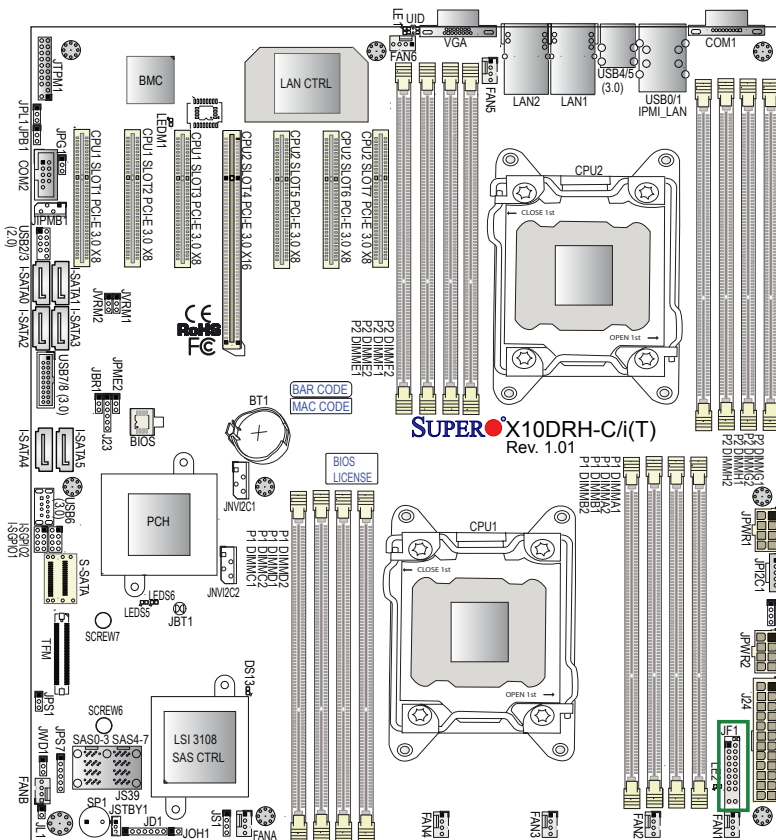

|                   | 1  | 2  |                               |
|-------------------|----|----|-------------------------------|
| Power Button      | ○  | ○  | Ground                        |
| Reset Button      | ○  | ○  | Ground                        |
| 3.3V              | ○  | ○  | Power Fail LED                |
| UID LED           | ○  | ○  | OH/Fan Fail/<br>PWR Fail LED) |
| NIC2 Activity LED | ○  | ○  | NIC2 Link LED                 |
| NIC1 Activity LED | ○  | ○  | NIC1 Link LED                 |
| UID Switch        | ○  | ○  | HDD LED                       |
| 3.3 V             | ○  | ○  | FP PWRLED                     |
| X                 | ○  | ○  | X                             |
| NMI               | ○  | ○  | Ground                        |
|                   | 19 | 20 |                               |

## Front Control Panel Pin Definitions

### NMI Button

The non-maskable interrupt button header is located on pins 19 and 20 of JF1. Refer to the table on the right for pin definitions.

| NMI Button Pin Definitions (JF1) |            |
|----------------------------------|------------|
| Pin#                             | Definition |
| 19                               | Control    |
| 20                               | Ground     |

### Power LED

The Power LED connection is located on pins 15 and 16 of JF1. Refer to the table on the right for pin definitions.

| Power LED Pin Definitions (JF1) |            |
|---------------------------------|------------|
| Pin#                            | Definition |
| 15                              | 3.3V       |
| 16                              | PWR LED    |

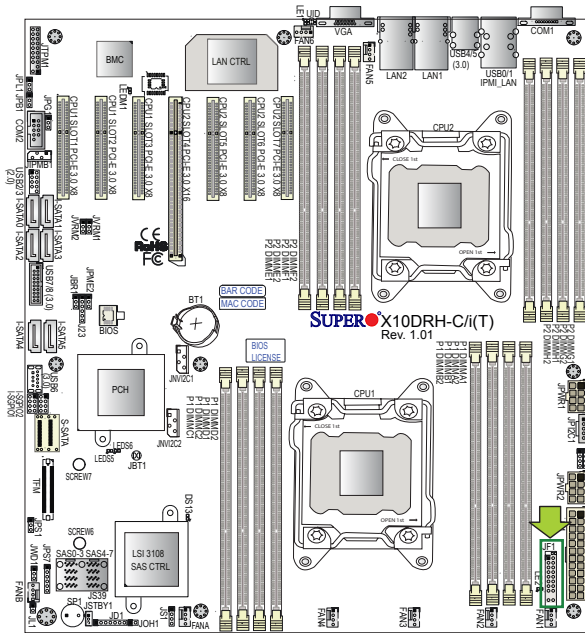

A. NMI  
B. PWR LED

|                   | 1  | 2  |                               |
|-------------------|----|----|-------------------------------|
| Power Button      | ○  | ○  | Ground                        |
| Reset Button      | ○  | ○  | Ground                        |
| 3.3V              | ○  | ○  | Power Fail LED                |
| UID LED           | ○  | ○  | OH/Fan Fail/<br>PWR Fail LED) |
| NIC2 Activity LED | ○  | ○  | NIC2 Link LED                 |
| NIC1 Activity LED | ○  | ○  | NIC1 Link LED                 |
| UID Switch        | ○  | ○  | HDD LED                       |
| 3.3 V             | ○  | ○  | FP PWRLED <b>B</b>            |
| X                 | ○  | ○  | X                             |
| <b>A</b> NMI      | ○  | ○  | Ground                        |
|                   | 19 | 20 |                               |

### HDD/UID LED

The HDD LED connection is located on pins 13 and 14 of JF1. Attach a cable to pin 14 to show the HDD activity status. Attach a cable to pin 13 to use the UID switch. See the table on the right for pin definitions.

| HDD LED<br>Pin Definitions (JF1) |            |
|----------------------------------|------------|
| Pin#                             | Definition |
| 13                               | UID Switch |
| 14                               | HD Active  |

### NIC1/NIC2 LED Indicators

The NIC (Network Interface Controller) LED connection for LAN port 1 is located on pins 11 and 12 of JF1, and the LED connection for LAN port 2 is on pins 9 and 10. Attach the NIC LED cables here to display network activity. Refer to the table on the right for pin definitions.

| GLAN1/2 LED<br>Pin Definitions (JF1) |                    |
|--------------------------------------|--------------------|
| Pin#                                 | Definition         |
| 9                                    | NIC 2 Activity LED |
| 10                                   | NIC 2 Link LED     |
| 11                                   | NIC 1 Activity LED |
| 12                                   | NIC 1 Link LED     |

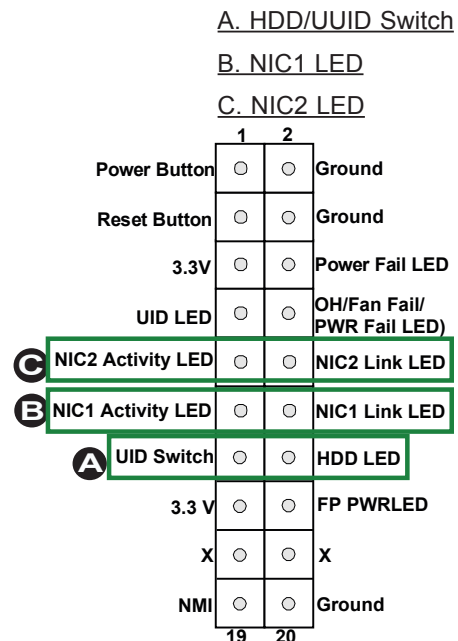
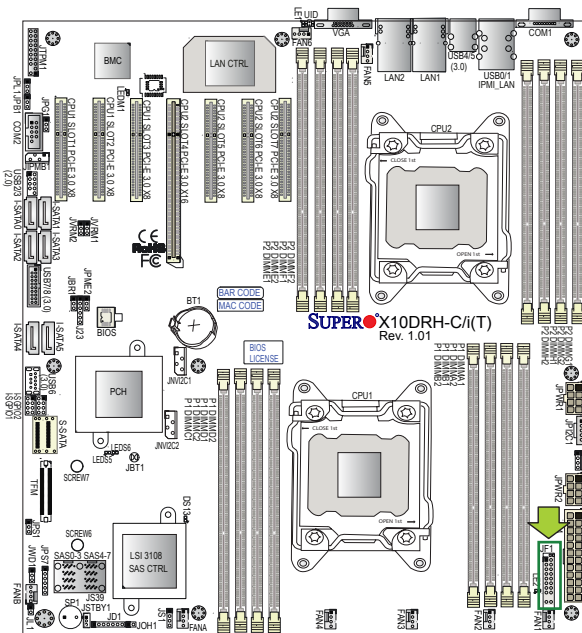

### Overheat (OH)/Fan Fail/PWR Fail/UID LED

Connect an LED cable to pins 7 and 8 of the front control panel to use the Overheat/Fan Fail/Power Fail and UID LED connections. The red LED on pin 8 provides warnings of over-heat, fan failure, or power failure. The blue LED on pin 7 works as the front-panel UID LED indicator. Refer to the table on the right for pin definitions.

| OH/Fan Fail/ PWR Fail/Blue_UID LED Pin Definitions (JF1) |                        |
|----------------------------------------------------------|------------------------|
| Pin#                                                     | Definition             |
| 7                                                        | Blue UID LED           |
| 8                                                        | OH/Fan Fail/Power Fail |

| OH/Fan Fail/PWR Fail LED Status (Red LED) |            |
|-------------------------------------------|------------|
| State                                     | Definition |
| Off                                       | Normal     |
| On                                        | Overheat   |
| Flashing                                  | Fan Fail   |

### Power Fail LED

The Power Fail LED connection is located on pins 5 and 6 of JF1. Refer to the table on the right for pin definitions.

| PWR Fail LED Pin Definitions (JF1) |                 |
|------------------------------------|-----------------|
| Pin#                               | Definition      |
| 5                                  | 3.3V            |
| 6                                  | PWR Supply Fail |

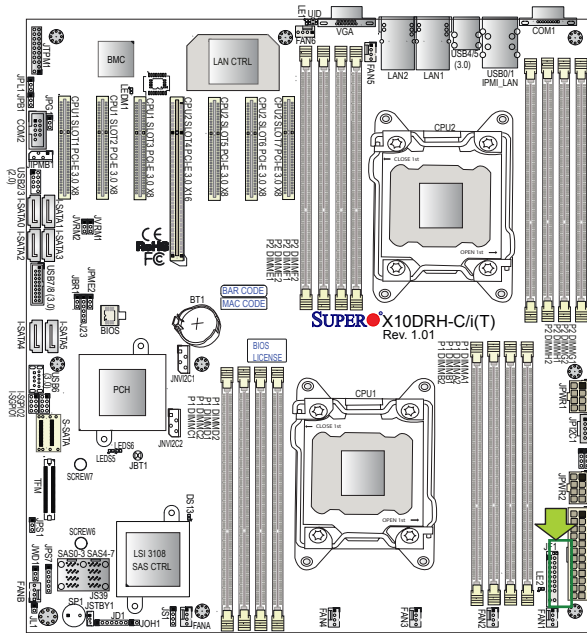

A. OH/Fail/PWR Fail LED

B. PWR Supply Fail

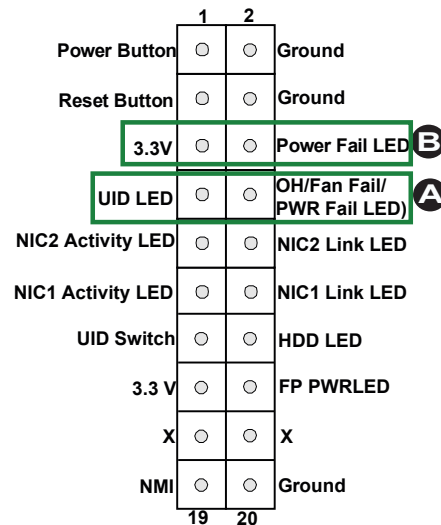



### Reset Button

The Reset Button connection is located on pins 3 and 4 of JF1. Attach it to a hardware reset switch on the computer case to support system reset. Refer to the table on the right for pin definitions.

| Reset Button<br>Pin Definitions (JF1) |            |
|---------------------------------------|------------|
| Pin#                                  | Definition |
| 3                                     | Reset      |
| 4                                     | Ground     |

### Power Button

The Power Button connection is located on pins 1 and 2 of JF1. Momentarily contacting both pins will power on/off the system. To turn on or off the system power, press the button for 4 seconds or longer. Refer to the table on the right for pin definitions.

| Power Button<br>Pin Definitions (JF1) |            |
|---------------------------------------|------------|
| Pin#                                  | Definition |
| 1                                     | Signal     |
| 2                                     | Ground     |

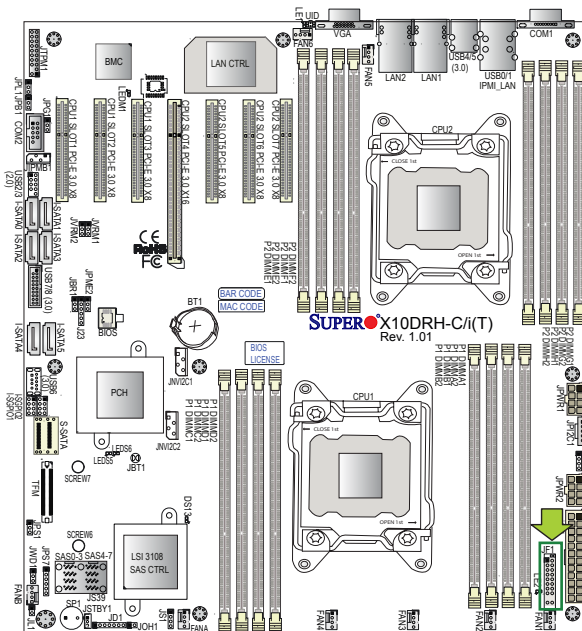

#### A. Reset Button

#### B. PWR Button

|                       | 1                     | 2                     |                               |
|-----------------------|-----------------------|-----------------------|-------------------------------|
| <b>B</b> Power Button | <input type="radio"/> | <input type="radio"/> | Ground                        |
| <b>A</b> Reset Button | <input type="radio"/> | <input type="radio"/> | Ground                        |
| 3.3V                  | <input type="radio"/> | <input type="radio"/> | Power Fail LED                |
| UID LED               | <input type="radio"/> | <input type="radio"/> | OH/Fan Fail/<br>PWR Fail LED) |
| NIC2 Activity LED     | <input type="radio"/> | <input type="radio"/> | NIC2 Link LED                 |
| NIC1 Activity LED     | <input type="radio"/> | <input type="radio"/> | NIC1 Link LED                 |
| UID Switch            | <input type="radio"/> | <input type="radio"/> | HDD LED                       |
| 3.3 V                 | <input type="radio"/> | <input type="radio"/> | FP PWRLED                     |
| X                     | <input type="radio"/> | <input type="radio"/> | X                             |
| NMI                   | <input type="radio"/> | <input type="radio"/> | Ground                        |
|                       | 19                    | 20                    |                               |

## 2-8 Connecting Cables

### Power Connectors

A 24-pin main power supply connector (J24) and two 8-pin CPU power connectors (JPWR1/ JPWR2) are located on the motherboard. These power connectors meet the SSI EPS 12V specification and must be connected to your power supply to provide adequate power to the system. See the tables on the right for pin definitions.

**Warning:** To provide adequate power supply to the motherboard, be sure to connect the 24-pin ATX PWR (J24) and the two 8-pin PWR connectors (JPWR1, JPWR2) to the power supply. Failure to do so may void the manufacturer warranty on your power supply and motherboard.

| Pin# | Definition | Pin # | Definition |
|------|------------|-------|------------|
| 13   | +3.3V      | 1     | +3.3V      |
| 14   | -12V (NC)  | 2     | +3.3V      |
| 15   | COM        | 3     | COM        |
| 16   | PS_ON      | 4     | +5V        |
| 17   | COM        | 5     | COM        |
| 18   | COM        | 6     | +5V        |
| 19   | COM        | 7     | COM        |
| 20   | Res (NC)   | 8     | PWR_OK     |
| 21   | +5V        | 9     | 5VSB       |
| 22   | +5V        | 10    | +12V       |
| 23   | +5V        | 11    | +12V       |
| 24   | COM        | 12    | +3.3V      |

| Pins        | Definition |
|-------------|------------|
| 1 through 4 | Ground     |
| 5 through 8 | +12V       |

(Required)

A. J24: 24-Pin ATX PWR

(required)

B. JPWR1: 8-Pin Processor PWR (required)

C. JPWR2: 8-Pin Processor PWR (required)

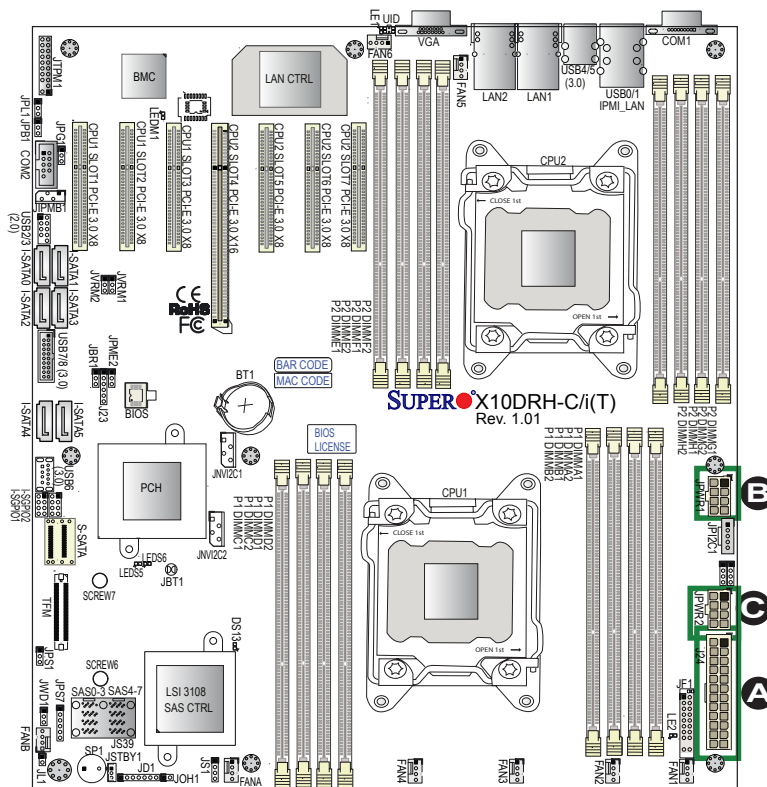

### Fan Headers

This motherboard has eight system/ CPU fan headers (Fans 1-6, Fan A, and Fan B). All these 4-pin fans headers are backward-compatible with the traditional 3-pin fans. However, fan speed control is available for 4-pin fans only by Thermal Management via the IPMI 2.0 interface. See the table on the right for pin definitions.

| Fan Header Pin Definitions |                |
|----------------------------|----------------|
| Pin#                       | Definition     |
| 1                          | Ground         |
| 2                          | +12V           |
| 3                          | Tachometer     |
| 4                          | PWR Modulation |

### Chassis Intrusion

A Chassis Intrusion header is located at JL1 on the motherboard. Attach an appropriate cable from the chassis to inform you of a chassis intrusion when the chassis is opened.

| Chassis Intrusion Pin Definitions |                 |
|-----------------------------------|-----------------|
| Pin#                              | Definition      |
| 1                                 | Intrusion Input |
| 2                                 | Ground          |

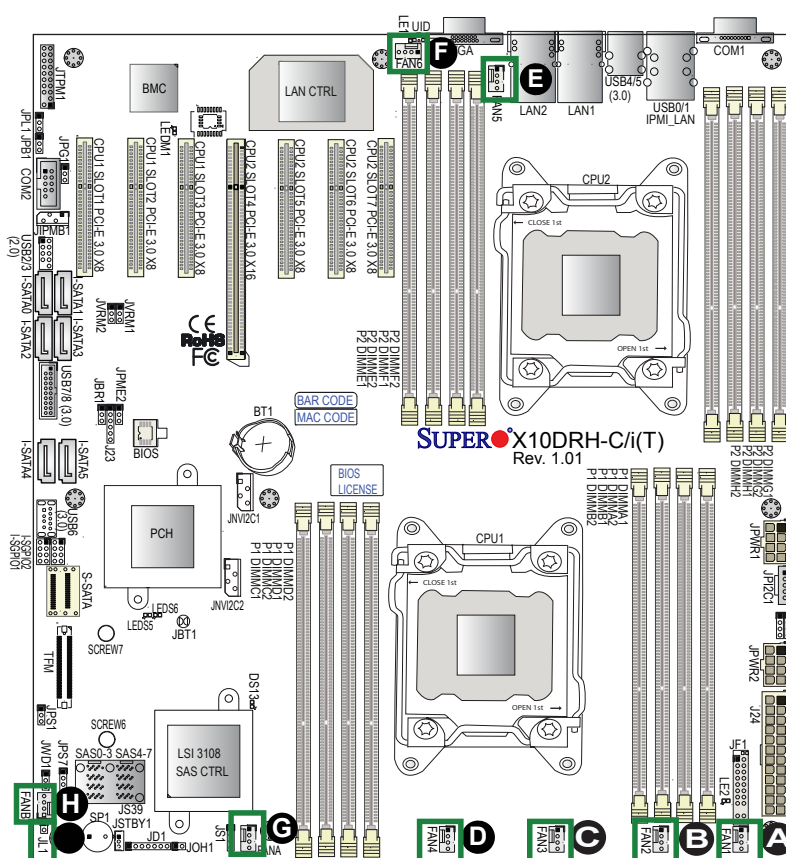

- A. Fan 1
- B. Fan 2
- C. Fan 3
- D. Fan 4
- E. Fan 5
- F. Fan 6
- G. Fan A
- H. Fan B
- I. Chassis Intrusion

### Internal Speaker

The Internal Speaker (SP1) can be used to provide audible notifications using various beep codes. See the table on the right for pin definitions. Refer to the layout below for the location of the internal buzzer.

| Internal Buzzer Pin Definition |             |               |
|--------------------------------|-------------|---------------|
| Pin#                           | Definitions |               |
| Pin 1                          | Pos. (+)    | Beep In       |
| Pin 2                          | Neg. (-)    | Alarm Speaker |

### Power LED/Speaker

Pins 1-3 of JD1 are used for power LED indication, and pins 4-7 are for the speaker. Please note that the speaker connector pins (4-7) are used with an external speaker. If you wish to use the onboard speaker, you should close pins 6-7 with a cap. See the tables on the right for pin definitions.

| PWR LED Connector Pin Definitions |            |
|-----------------------------------|------------|
| Pin Setting                       | Definition |
| Pin 1                             | JD1_PIN1   |
| Pin 2                             | FP_PWR_LED |
| Pin 3                             | FP_PWR_LED |

| Speaker Connector Pin Settings |            |
|--------------------------------|------------|
| Pin Setting                    | Definition |
| Pin 4                          | P5V        |
| Pin 5                          | Key        |
| Pin 6                          | R_SPKPIN_N |
| Pin 7                          | R_SPKPIN   |

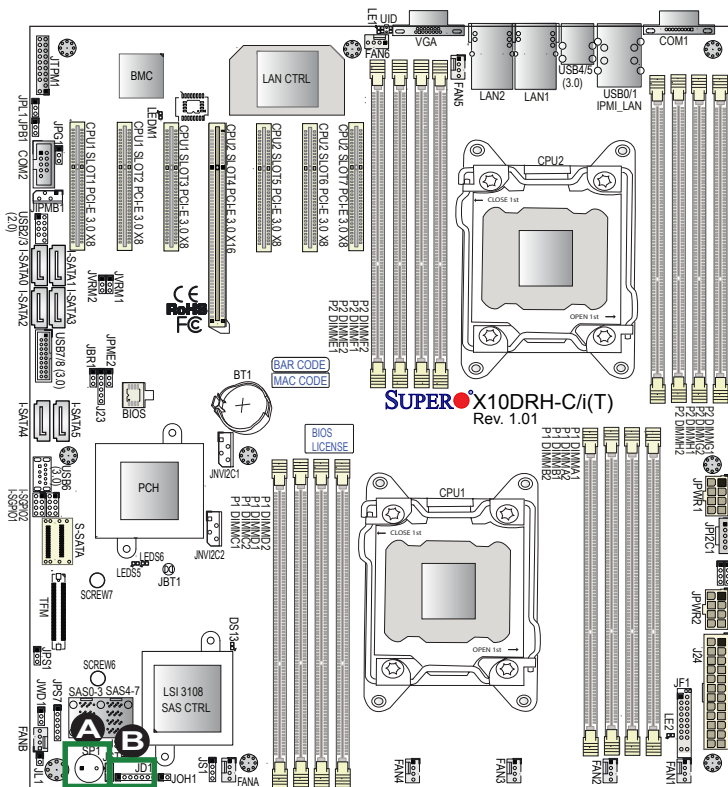

### A. Internal Speaker

(Buzzer)

B. Power LED

### TPM/Port 80 Header

A Trusted Platform Module (TPM)/Port 80 header is located at JTPM1 to provide TPM support and a Port 80 connection. Use this header to enhance system performance and data security. See the table on the right for pin definitions.

| TPM/Port 80 Header Pin Definitions |               |       |               |
|------------------------------------|---------------|-------|---------------|
| Pin #                              | Definition    | Pin # | Definition    |
| 1                                  | LCLK          | 2     | GND           |
| 3                                  | LFRAME#       | 4     | <(KEY)>       |
| 5                                  | LRESET#       | 6     | No Connection |
| 7                                  | LAD 3         | 8     | LAD 2         |
| 9                                  | +3.3V         | 10    | LAD1          |
| 11                                 | LAD0          | 12    | GND           |
| 13                                 | No Connection | 14    | No Connection |
| 15                                 | +3V STBY      | 16    | SERIRQ        |
| 17                                 | GND           | 18    | CLKRUN#       |
| 19                                 | LPCPD#        | 20    | No Connection |

### NVMe I<sup>2</sup>C Header

Connectors JNVI<sup>2</sup>C1 and JNVI<sup>2</sup>C2 are management headers for the Supermicro AOC NVMe PCI-E peripheral cards. Please connect the I<sup>2</sup>C cable to this connector.

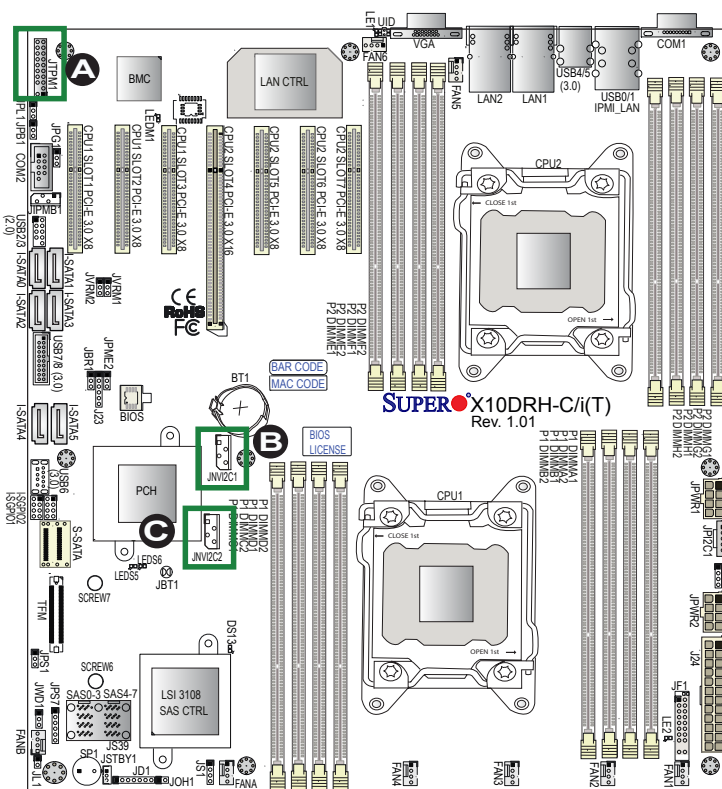

A. TPM/Port 80 Header

B. JNVI<sup>2</sup>C1

C. JNVI<sup>2</sup>C2

### Power SMB (I<sup>2</sup>C) Connector

The Power System Management Bus (I<sup>2</sup>C) connector (JPI<sup>2</sup>C1) monitors power supply, fan, and system temperatures. See the table on the right for pin definitions.

| PWR SMB Pin Definitions |             |
|-------------------------|-------------|
| Pin#                    | Definition  |
| 1                       | Clock       |
| 2                       | Data        |
| 3                       | PMBUS_Alert |
| 4                       | Ground      |
| 5                       | +3.3V       |

### IPMB

A System Management Bus header for IPMI 2.0 is located at JIPMB1. Connect the appropriate cable here to use the IPMB I<sup>2</sup>C connection on your system.

| IPMB Header Pin Definitions |               |
|-----------------------------|---------------|
| Pin#                        | Definition    |
| 1                           | Data          |
| 2                           | Ground        |
| 3                           | Clock         |
| 4                           | No Connection |

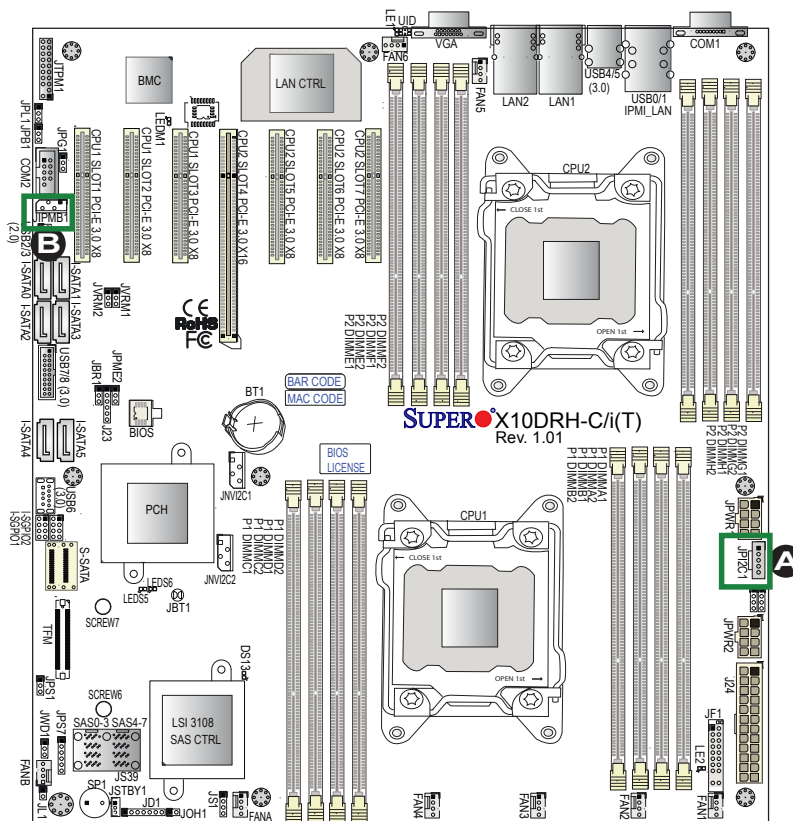

- A. JPI<sup>2</sup>C1
- B. JIPMB1

### I-SGPIO 1/2 Headers

Two SGPIO (Serial Link General Purpose Input/Output) headers are located on the motherboard. I-SGPIO1 supports onboard I-SATA0-3 ports, while I-SGPIO2 supports I-SATA4/5 connections. See the table on the right for pin definitions.

| I-SGPIO 1/2 Headers<br>Pin Definitions |            |     |            |
|----------------------------------------|------------|-----|------------|
| Pin#                                   | Definition | Pin | Definition |
| 2                                      | NC         | 1   | NC         |
| 4                                      | Ground     | 3   | Data       |
| 6                                      | Load       | 5   | Ground     |
| 8                                      | Clock      | 7   | NC         |

**Note:** NC= No Connection

| I-SGPIO 1/2 |                     |
|-------------|---------------------|
| I-SGPIO1    | I-SATA0-3 supported |
| I-SGPIO2    | I-SATA4/5 supported |

### Standby Power Header

The +5V Standby Power header is located at JSTBY1 on the motherboard. See the table on the right for pin definitions. (You must also have a card with a Standby Power connector and a cable to use this feature.)

| Standby PWR<br>Pin Definitions |               |
|--------------------------------|---------------|
| Pin#                           | Definition    |
| 1                              | +5V Standby   |
| 2                              | Ground        |
| 3                              | No Connection |

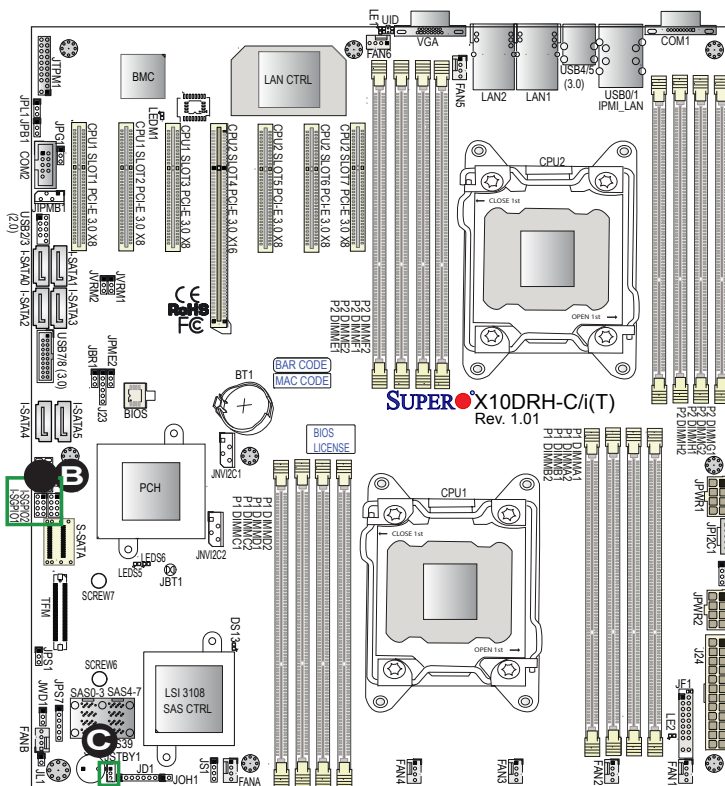

- A. I-SGPIO1
- B. I-SGPIO2
- C. Standby PWR

## 2-9 Jumper Settings

### Explanation of Jumpers

To modify the operation of the motherboard, jumpers can be used to choose between optional settings. Jumpers create shorts between two pins to change the function of the connector. Pin 1 is identified with a square solder pad on the printed circuit board. See the motherboard layout pages for jumper locations.

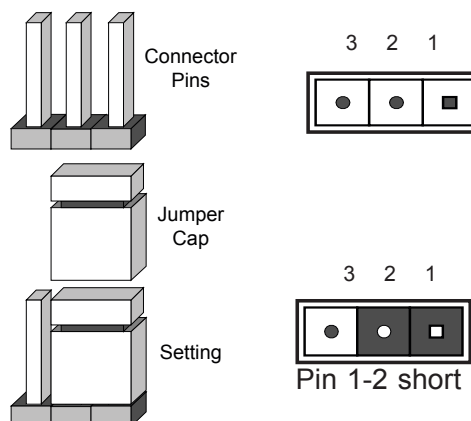

**Note:** On two-pin jumpers, "closed" means the jumper is on the pins, and "open" means the jumper is off them.

### LAN Enable/Disable

JPL1 enables or disables Gigabit LAN ports 1/2 on the X10DRH-C/i and 10G-LAN (TLAN) ports 1/2 on the X10DRH-CT/iT. See the table on the right for jumper settings. The default setting is Enabled.

| LAN Enable Jumper Settings |                   |
|----------------------------|-------------------|
| Jumper Setting             | Definition        |
| 1-2                        | Enabled (default) |
| 2-3                        | Disabled          |

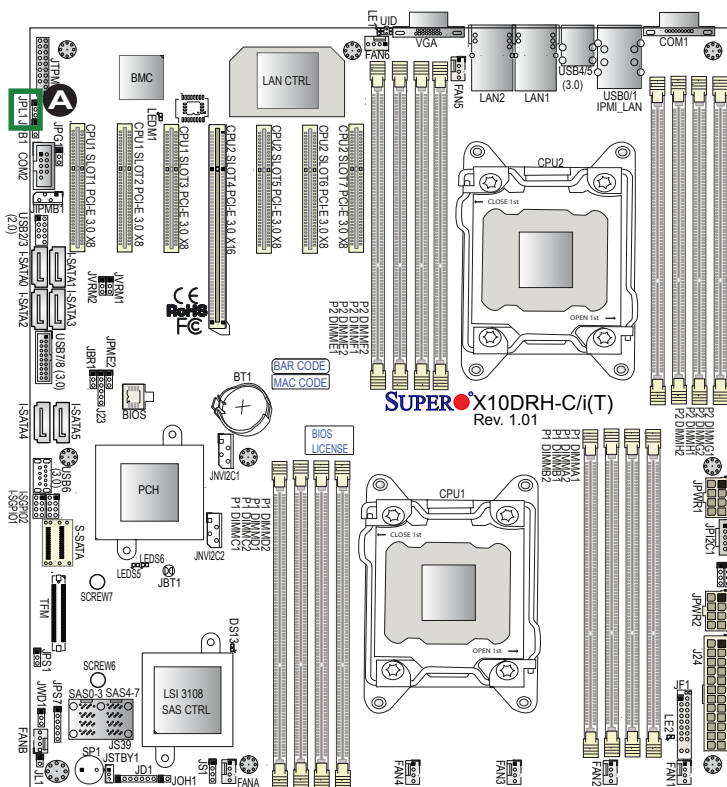

A. GLAN1/2 Enable (X10DRH-C/i)

A. 10G LAN (TLAN) 1/2 Enable (X10DRH-CT/iT)



### CMOS Clear

JBT1 is used to clear the CMOS. Instead of pins, this "jumper" consists of contact pads to prevent accidental clearing of the CMOS. To clear the CMOS, use a metal object such as a small screwdriver to touch both pads at the same time to short the connection.

 **Note:** Be sure to completely shut down the system, and then short JBT1 to clear the CMOS.

### Watch Dog Enable/Disable

The Watch Dog (JWD1) is a system monitor that will reboot the system when a software application hangs. Close pins 1-2 to reset the system if an application hangs. Close pins 2-3 to generate a non-maskable interrupt signal for the application that hangs. See the table on the right for jumper settings. The Watch Dog must also be enabled in the BIOS.

| Watch Dog Jumper Settings |                 |
|---------------------------|-----------------|
| Jumper Setting            | Definition      |
| 1-2                       | Reset (default) |
| 2-3                       | NMI             |
| Open                      | Disabled        |

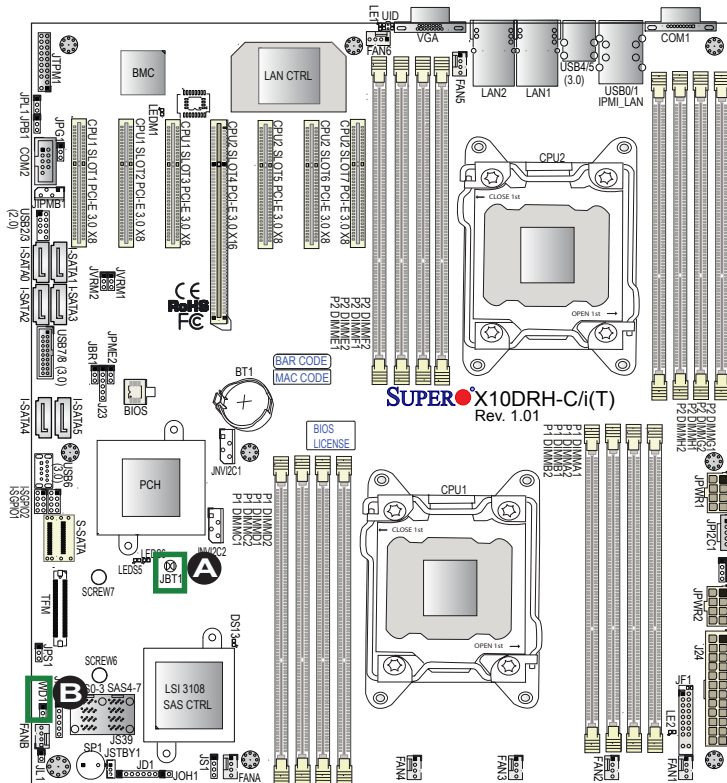

- A. Clear CMOS
- B. Watch Dog Enable

### VGA Enable

Jumper JPG1 allows the user to enable the onboard VGA connector. The default setting is 1-2 to enable the connection. See the table on the right for jumper settings.

| VGA Enable Jumper Settings |                   |
|----------------------------|-------------------|
| Jumper Setting             | Definition        |
| 1-2                        | Enabled (Default) |
| 2-3                        | Disabled          |

### BMC Enable

Jumper JPB1 allows you to enable the embedded ASpeed AST2400 Baseboard Management Controller (BMC) to provide IPMI 2.0/KVM support on the motherboard. See the table on the right for jumper settings.

| BMC Enable Jumper Settings |                      |
|----------------------------|----------------------|
| Jumper Setting             | Definition           |
| 1-2                        | BMC Enable (Default) |
| 2-3                        | Disabled             |

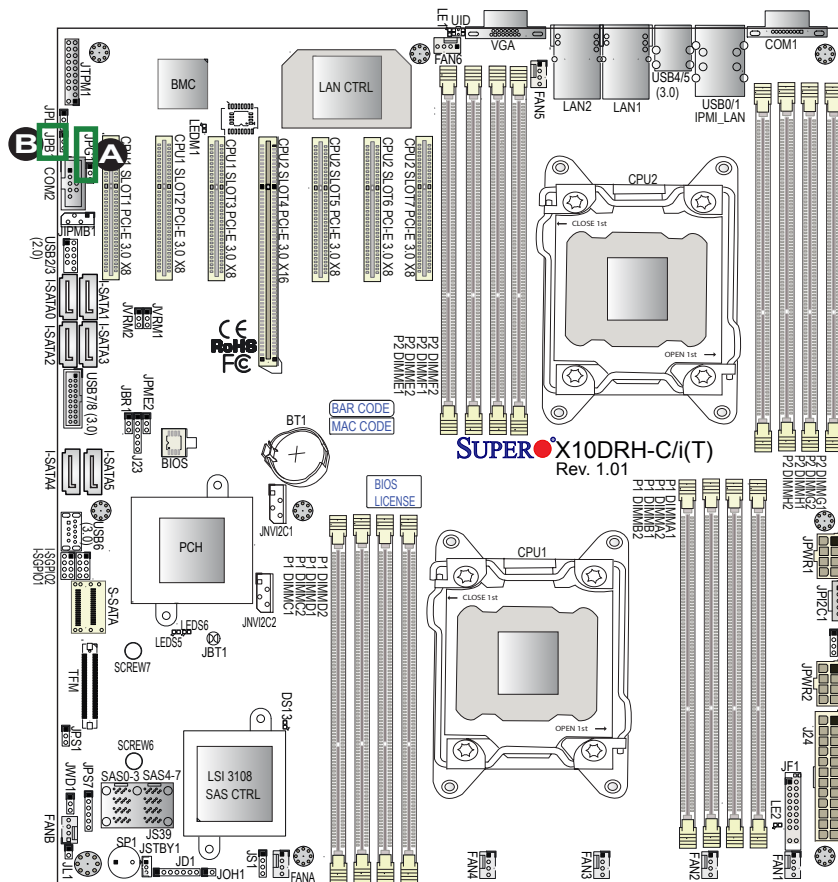

A. VGA Enabled  
B. BMC Enabled

### I<sup>2</sup>C Bus for VRM

Jumpers JVRM1 and JVRM2 allow the BMC or the PCH to access CPU and memory VRM controllers. See the table below for jumper settings.

| VRMt<br>Jumper Settings |              |
|-------------------------|--------------|
| Jumper Setting          | Definition   |
| 1-2                     | BMC (Normal) |
| 2-3                     | PCH          |

### Manufacturer Mode Select

Close pin 2 and pin 3 of Jumper JPME2 to bypass SPI flash security and force the system to operate in the manufacturer mode, which will allow the user to flash the system firmware from a host server for system setting modifications. See the table on the right for jumper settings.

| ME Mode Select<br>Jumper Settings |                  |
|-----------------------------------|------------------|
| Jumper Setting                    | Definition       |
| 1-2                               | Normal (Default) |
| 2-3                               | Manufacture Mode |

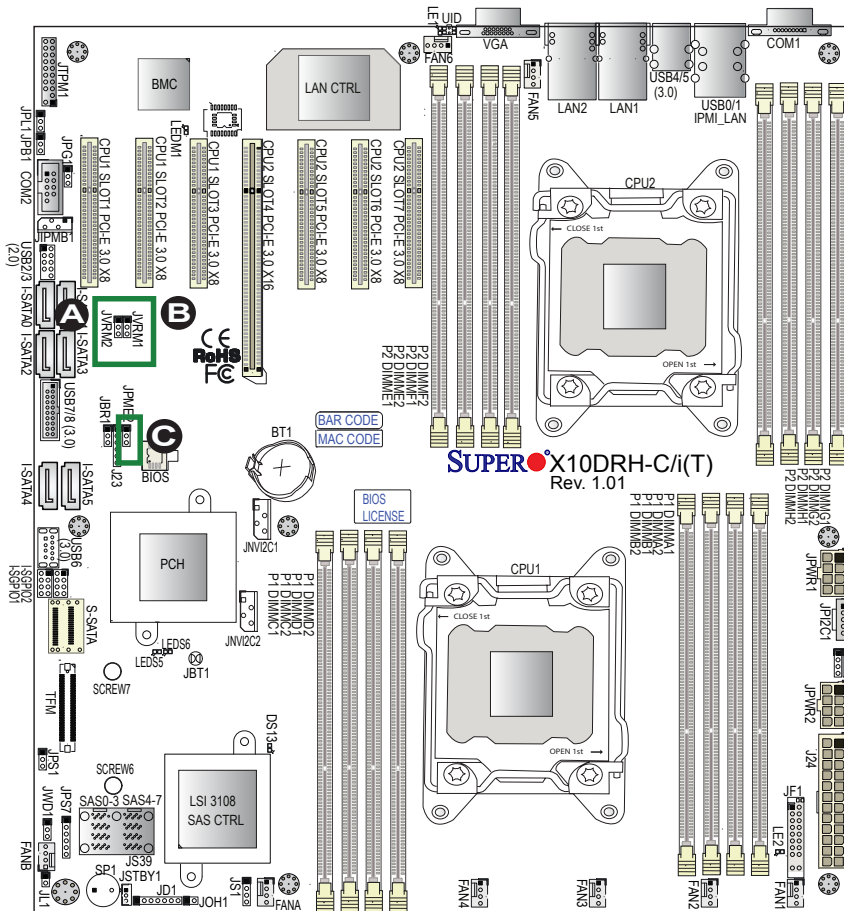

- A. JVRM2
- B. JVRM1
- C. ME Select

**SAS Enable (X10DRH-C/CT only)**

Jumper JPS1 allows the user to enable the onboard SAS connections. The default setting is 1-2 (enabled). See the table on the right for jumper settings.

| SAS Enable Jumper Settings |                   |
|----------------------------|-------------------|
| Jumper Setting             | Definition        |
| 1-2                        | Enabled (Default) |
| 2-3                        | Disabled          |

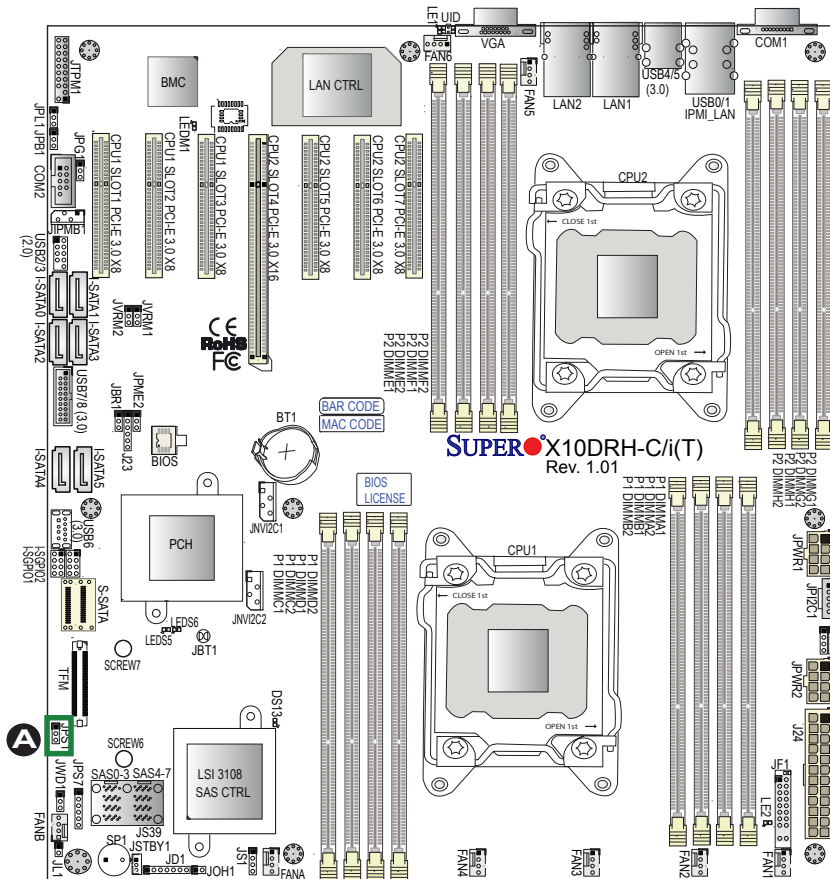

A. SAS Enabled

## 2-10 Onboard LED Indicators

### GLAN LEDs

Two LAN ports (LAN 1 and LAN 2) are located on the IO back panel of the motherboard. Each Ethernet LAN port has two LEDs. The green LED indicates activity, while the other Link LED may be green, amber, or off to indicate the speed of the connection. See the tables at right for more information.



**Rear View** (when facing the rear side of the chassis)

| LAN 1/LAN 2 Activity LED (Right) LED State |          |            |
|--------------------------------------------|----------|------------|
| Color                                      | Status   | Definition |
| Green                                      | Flashing | Active     |

| LAN 1/LAN 2 Link LED (Left) LED State |                                     |
|---------------------------------------|-------------------------------------|
| LED Color                             | Definition                          |
| Off                                   | 10 Mbps, 100 Mbps, or No Connection |
| Green                                 | 10 Gbps (X10DRH-CT/iT only)         |
| Amber                                 | 1 Gbps                              |

### IPMI-Dedicated LAN LEDs

In addition to LAN 1 and LAN 2, an IPMI LAN is also located on the I/O back panel. The amber LED on the right indicates activity, while the green LED on the left indicates the speed of the connection. See the table at right for more information.



| IPMI LAN Link LED (Left) & Activity LED (Right) |                              |                    |
|-------------------------------------------------|------------------------------|--------------------|
|                                                 | Color/State                  | Definition         |
| Link (Left)                                     | Green: Solid<br>Amber: Solid | 100 Mbps<br>1 Gbps |
| Activity (Right)                                | Amber: Blinking              | Active             |

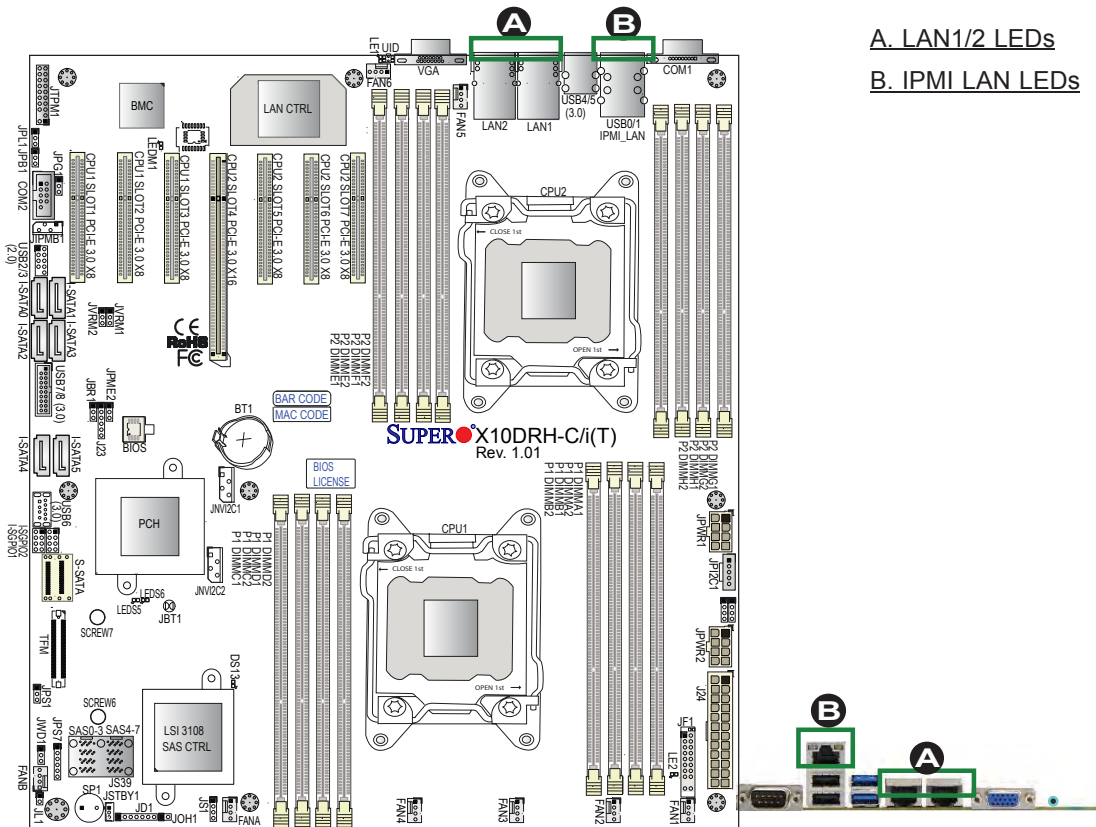

A. LAN1/2 LEDs

B. IPMI LAN LEDs

### Onboard Power LED

The Onboard Power LED is located at LE2 on the motherboard. When this LED is on, the system is on. Be sure to turn off the system and unplug the power cord before removing or installing components. See the table on the right for more information.

| Onboard PWR LED Indicator LED States |                                      |
|--------------------------------------|--------------------------------------|
| LED Color                            | Definition                           |
| Off                                  | System Off (PWR cable not connected) |
| Green                                | System On                            |

### BMC Heartbeat LED

A BMC Heartbeat LED is located at LEDM1 on the motherboard. When LEDM1 is blinking, the BMC is functioning normally. See the table on the right for more information.

| BMC Heartbeat LED States |             |
|--------------------------|-------------|
| Color/State              | Definition  |
| Green:<br>Blinking       | BMC: Normal |

 **Note:** Refer to Page 2-22 for information on the rear UID LED (LE1).

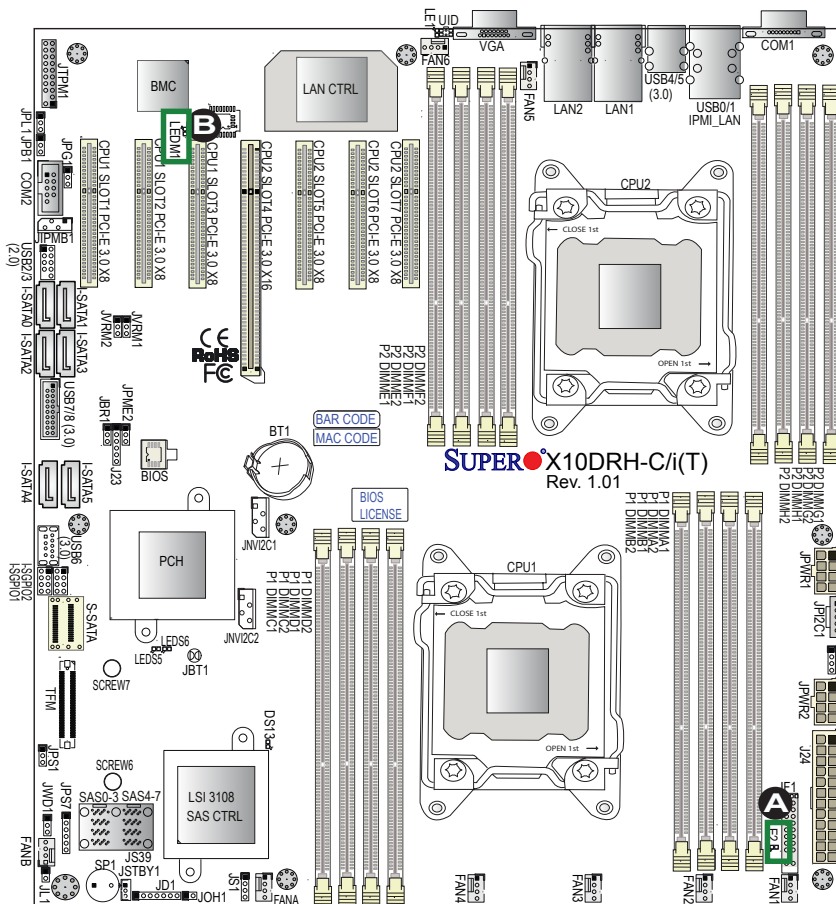

- A. PWR LED
- B. BMC LED

### SAS Activity LED (For X10DRH-C/CT)

The SAS Activity LED is located at LEDS5 on the motherboard. When LEDS5 is blinking, the SAS drive supported by the LSI 3108 controller is active. See the table on the right for more information.

| SAS Activity LED Status |             |
|-------------------------|-------------|
| Color/State             | Definition  |
| Green: Blinking         | SAS: Active |

### SAS Fault LED (For X10DRH-C/CT)

The SAS Fault LED is located at LEDS6 on the motherboard. When LEDS6 is on, an error has occurred to the SAS drive supported by the LSI 3108 controller. See the table on the right for more information.

| SATA Fault LED Status |                       |
|-----------------------|-----------------------|
| Color/State           | Definition            |
| Red: On               | SAS error(s) detected |

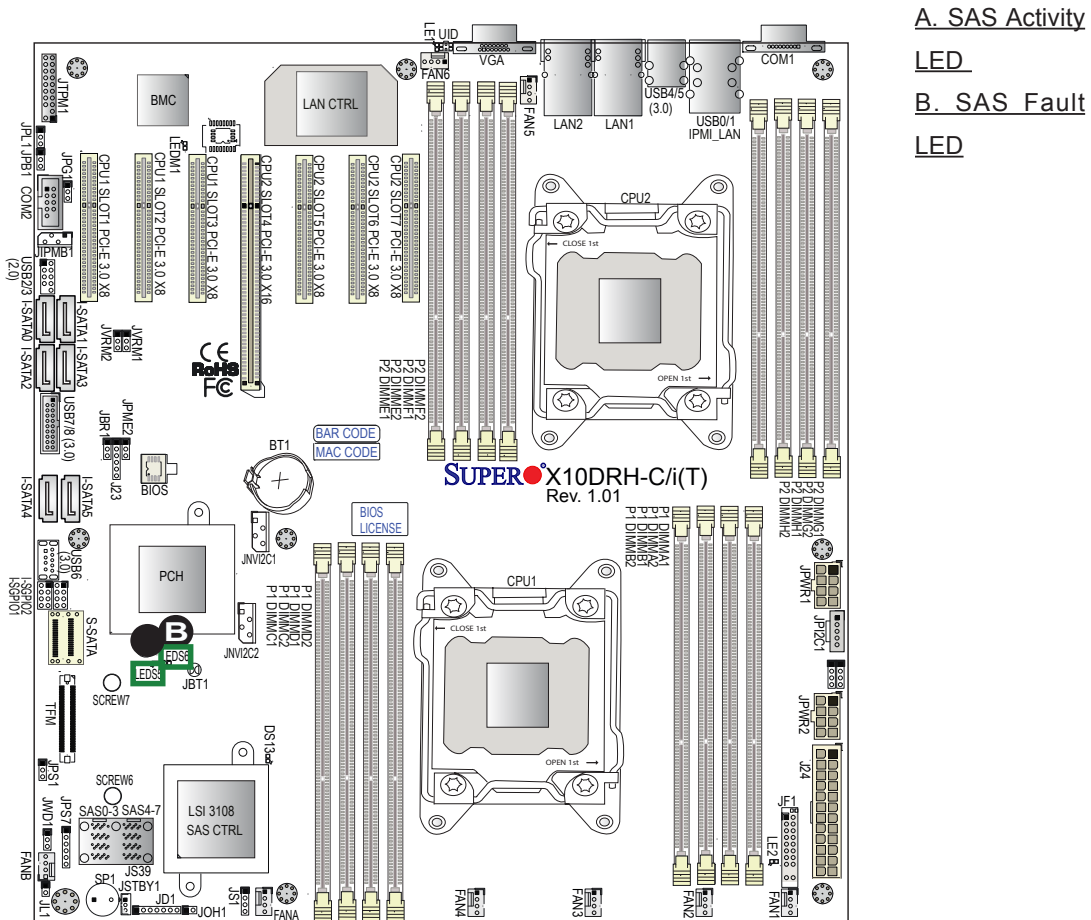

### SAS Heartbeat LED (For X10DRH-C/CT)

A SAS Heartbeat LED is located at DS13 on the motherboard. When DS13 is blinking, the SAS is functioning normally. See the table at right for more information.

| SAS Heartbeat LED Status |             |
|--------------------------|-------------|
| Color/State              | Definition  |
| Green: Blinking          | SAS: Normal |

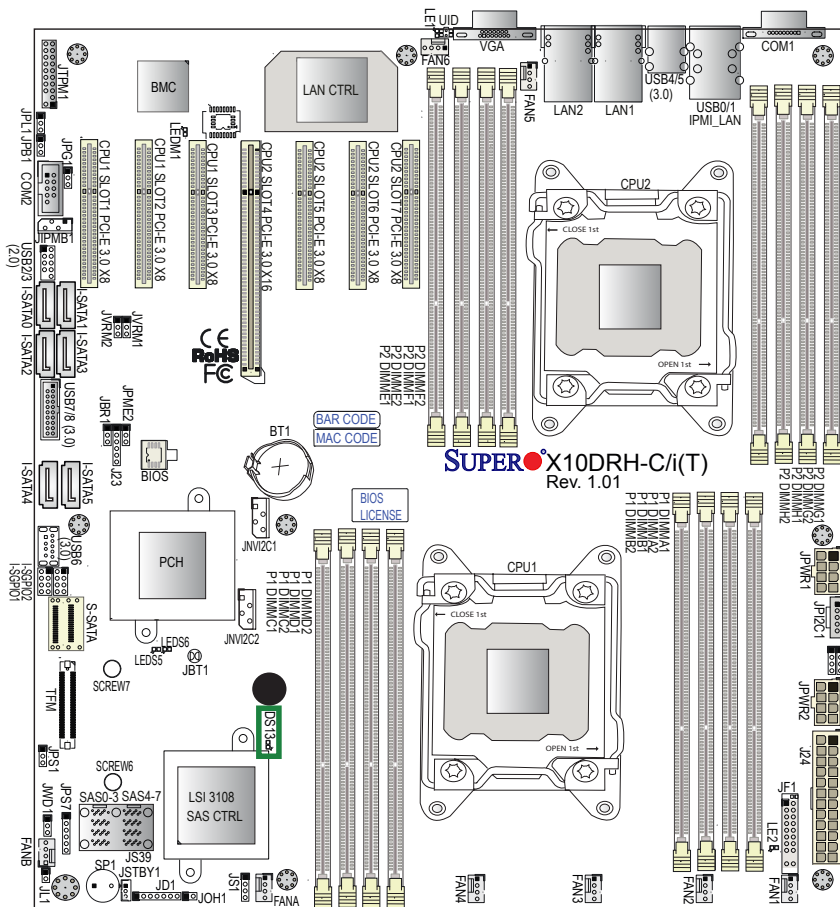

A. SAS Heartbeat LED



## 2-11 SATA/SAS Connections

### SATA 3.0 and S-SATA 3.0 Connections

Ten SATA 3.0 connections are located on the motherboard. Six SATA 3.0 ports (I-SATA 0-5) are supported by the Intel PCH C612. A vertical S-SATA connector, supported by the Intel SCU chip, offers four S-SATA 3.0 connections. These SATA ports provide serial-link signal connections, which are faster than the connections of Parallel ATA. See the table on the right for pin definitions.

 **Note 1:** Supermicro SuperDOMs are yellow SATADOM connectors with power pins built in and do not require separate external power cables. These connectors are backward-compatible with non-Supermicro SATA-DOMs that require an external power supply.

**Note 2:** For more information on the SATA HostRAID configuration, please refer to the Intel SATA HostRAID user's guide posted on our website at <http://www.supermicro.com..>

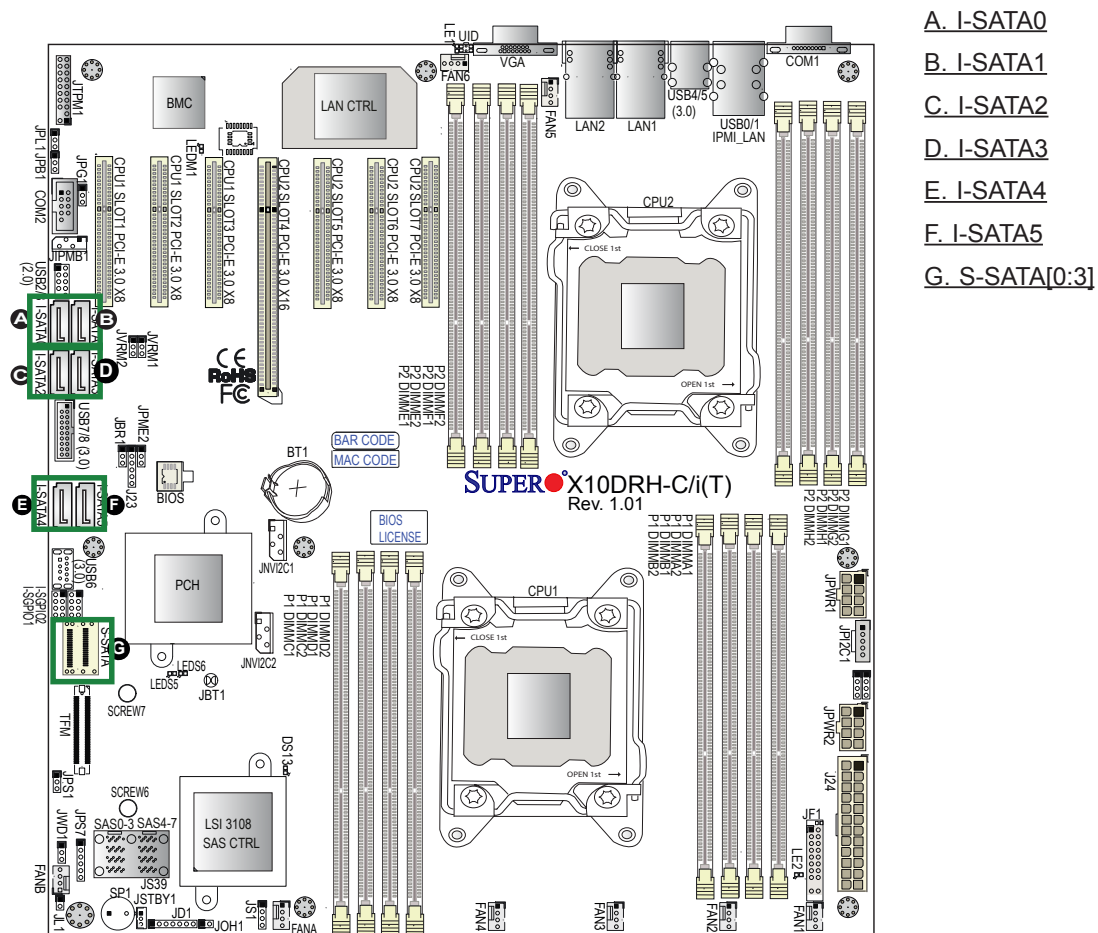

### SAS Ports (X10DRH-C/CT Only)

Eight SAS ports, supported by the LSI 3108 SAS controller, are located at JS39 on the motherboard. SAS 0-3 and SAS 4-7 support RAID 0, 1, 5, 6, 10, 50, 60 (Hardware RAID + 2GB cache) from the LSI 3108 with optional CacheVault available for system data protection. (Note below). See the layout below for the locations of SAS connectors.

 **Note:** Optional CacheVault can be purchased at Supermicro. Please visit our website at [www.supermicro.com](http://www.supermicro.com) for more information.

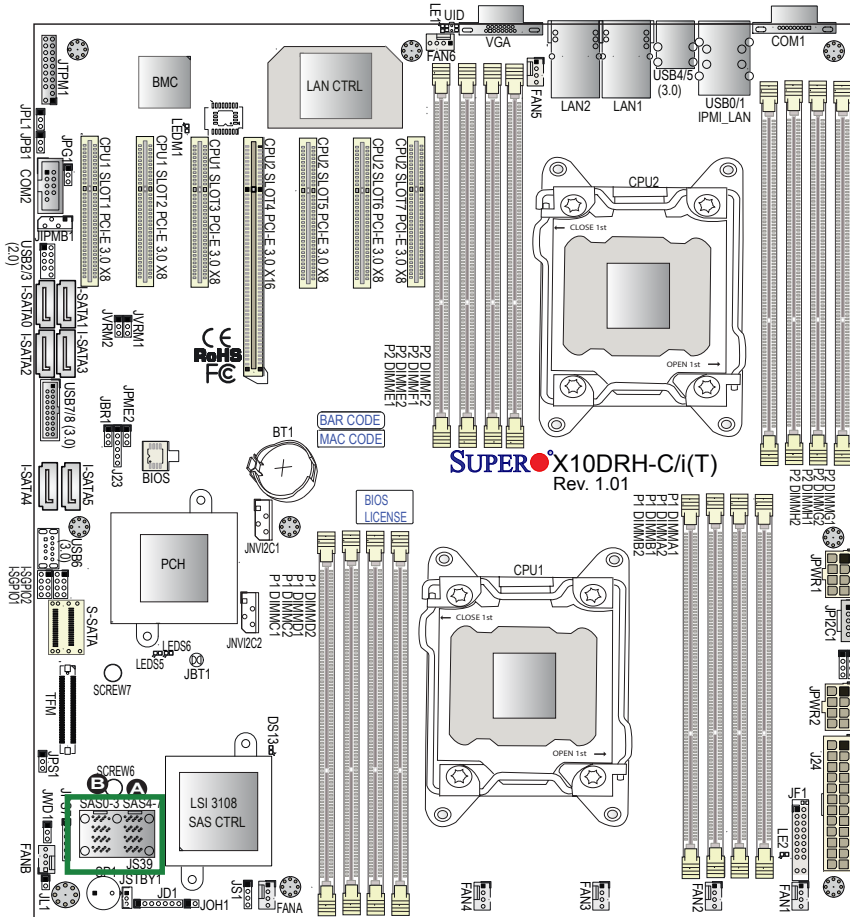

A. SAS0-3

B. SAS4-7

## Chapter 3

# Troubleshooting

### 3-1 Troubleshooting Procedures

Use the following procedures to troubleshoot your system. If you have followed all of the procedures below and still need assistance, refer to the "Technical Support Procedures" and/or "Returning Merchandise for Service" section(s) in this chapter.

**Note:** Always disconnect the power cord before adding, changing, or installing any hardware components.

#### **Before Power On**

1. Make sure that there are no short circuits between the motherboard and chassis.
2. Disconnect all ribbon/wire cables from the motherboard, including those for the keyboard and mouse.
3. Remove all add-on cards.
4. Install CPU 1 first (making sure it is fully seated) and connect the front panel connectors to the motherboard.

#### **No Power**

1. Make sure that there are no short circuits between the motherboard and the chassis.
2. Make sure that the ATX power connectors are properly connected.
3. Check that the 115V/230V switch, if available, on the power supply is properly set.
4. Turn the power switch on and off to test the system, if applicable.
5. The battery on your motherboard may be old. Check to verify that it still supplies ~3VDC. If it does not, replace it with a new one.

## No Video

1. If the power is on but you have no video, remove all add-on cards and cables.
2. Use the speaker to determine if any beep codes are present. Refer to Appendix A for details on beep codes.

## System Boot Failure

If the system does not display POST or does not respond after the power is turned on, check the following:

1. Check for any error beep from the motherboard speaker.
  - If there is no error beep, try to turn on the system without DIMM modules installed. If there is still no error beep, try to turn on the system again with only one processor installed in CPU Socket 1. If there is still no error beep, replace the motherboard.
  - If there are error beeps, clear the CMOS settings by unplugging the power cord and contacting both pads on the CMOS Clear Jumper (JB1). (Refer to the Jumper section in Chapter 2.)
2. Remove all components from the motherboard, especially the DIMM modules. Make sure that system power is on and that memory error beeps are activated.
3. Turn on the system with only one DIMM module installed. If the system boots, check for bad DIMM modules or slots by following the Memory Errors Troubleshooting procedure in this Chapter.

## Losing the System's Setup Configuration

1. Make sure that you are using a high-quality power supply. A poor-quality power supply may cause the system to lose the CMOS setup information. Refer to the Connecting Cables section for details on recommended power supplies.
2. The battery on your motherboard may be old. Check to verify that it still supplies ~3VDC. If it does not, replace it with a new one.
3. If the above steps do not fix the setup configuration problem, contact your vendor for repairs.

## Memory Errors

When a no-memory beep code is issued by the system, check the following:

1. Make sure that the memory modules are compatible with the system and that the DIMMs are properly and fully installed. (For memory compatibility, refer to the memory compatibility chart posted on our website @ <http://www.supermicro.com>.)
2. Check if different speeds of DIMMs have been installed. It is strongly recommended that you use the same RAM type and speed for all DIMMs in the system.
3. Make sure that you are using the correct type of Load Reduction (LRDIMM)/Registered (RDIMM) ECC DDR4 DIMM modules recommended by the manufacturer.
4. Check for bad DIMM modules or slots by swapping a single module among all memory slots and check the results.
5. Make sure that all memory modules are fully seated in their slots. Follow the instructions given in Section 2-5 in Chapter 2.
6. Please follow the instructions given in the DIMM population tables listed in Section 2-5 to install your memory modules.

## When the System Becomes Unstable

***A. If the system becomes unstable during or after OS installation, check the following:***

1. CPU/BIOS support: Make sure that your CPU is supported and that you have the latest BIOS installed in your system.
2. Memory support: Make sure that the memory modules are supported by testing the modules using memtest86 or a similar utility.

 **Note:** Refer to the product page on our website @ <http://www.supermicro.com> for memory and CPU support and updates.

3. HDD support: Make sure that all hard disk drives (HDDs) work properly. Replace the bad HDDs with good ones.
4. System cooling: Check the system cooling to make sure that all heatsink fans and CPU/system fans, etc., work properly. Check the hardware monitoring

settings in the IPMI to make sure that the CPU and system temperatures are within the normal range. Also check the front panel Overheat LED and make sure that it is not on.

5. Adequate power supply: Make sure that the power supply provides adequate power to the system. Make sure that all power connectors are connected. Please refer to our website for more information on the minimum power requirements.
6. Proper software support: Make sure that the correct drivers are used.

***B. If the system becomes unstable before or during OS installation, check the following:***

1. Source of installation: Make sure that the devices used for installation are working properly, including boot devices such as CD/DVD and CD/DVD-ROM.
2. Cable connection: Check to make sure that all cables are connected and working properly.
3. Using the minimum configuration for troubleshooting: Remove all unnecessary components (starting with add-on cards first), and use the minimum configuration (but with a CPU and a memory module installed) to identify the trouble areas. Refer to the steps listed in Section A above for proper troubleshooting procedures.
4. Identifying bad components by isolating them: If necessary, remove a component in question from the chassis, and test it in isolation to make sure that it works properly. Replace a bad component with a good one.
5. Check and change one component at a time instead of changing several items at the same time. This will help isolate and identify the problem.
6. To find out if a component is good, swap this component with a new one to see if the system will work properly. If so, then the old component is bad. You can also install the component in question in another system. If the new system works, the component is good and the old system has problems.

## 3-2 Technical Support Procedures

Before contacting Technical Support, please take the following steps. Also, please note that as a motherboard manufacturer, Supermicro also sells motherboards through its channels, so it is best to first check with your distributor or reseller for troubleshooting services. They should know of any possible problems with the specific system configuration that was sold to you.

1. Please go through the Troubleshooting Procedures and Frequently Asked Questions (FAQ) sections in this chapter or see the FAQs on our website (<http://www.supermicro.com/>) before contacting Technical Support.
2. BIOS upgrades can be downloaded from our website (<http://www.supermicro.com>).
3. If you still cannot resolve the problem, include the following information when contacting Supermicro for technical support:
  - Motherboard model and PCB revision number
  - BIOS release date/version (This can be seen on the initial display when your system first boots up.)
  - System configuration
4. An example of a Technical Support form is on our website at <http://www.supermicro.com/RmaForm/>.
  - Distributors: For immediate assistance, please have your account number ready when placing a call to our Technical Support department. We can be reached by email at [support@supermicro.com](mailto:support@supermicro.com).

## 3-3 Battery Removal and Installation

### Battery Removal

To remove the onboard battery, follow the steps below:

1. Power off your system and unplug your power cable.
2. Locate the onboard battery as shown below.
3. Using a tool such as a pen or a small screwdriver, push the battery lock outwards to unlock it. Once unlocked, the battery will pop out from the holder.
4. Remove the battery.

### Proper Battery Disposal

**Warning:** Please handle used batteries carefully. Do not damage the battery in any way; a damaged battery may release hazardous materials into the environment. Do not discard a used battery in the garbage or a public landfill. Please comply with the regulations set up by your local hazardous waste management agency to dispose of your used battery properly.

### Battery Installation

To install an onboard battery, follow the steps below:

1. Power off your system and unplug your power cable.
2. Locate the onboard battery as shown below.
3. Identify the battery's polarity. The positive (+) side should be facing up.
4. Insert the battery into the battery holder and push it down until you hear a click to ensure that the battery is securely locked.

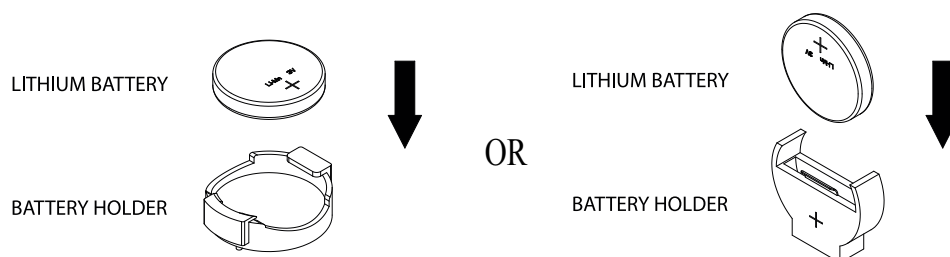



---

## 3-4 Frequently Asked Questions

**Question: What are the various types of memory that my motherboard can support?**

**Answer:** The motherboard supports Load Reduction (LRDIMM)/Registered (RDIMM) ECC DDR4 DIMM modules. To enhance memory performance, do not mix memory modules of different speeds and sizes. Please follow all memory installation instructions given on Section 2-5 in Chapter 2.

**Question: How do I update my BIOS under DOS?**

It is recommended that you **do not** upgrade your BIOS if you are not experiencing any problems with your system. Updated BIOS files are located on our website at <http://www.supermicro.com>. Please check our BIOS warning message and the information on how to update your BIOS on our website. Select your motherboard model and download the BIOS file to your computer. Also, check the current BIOS revision to make sure that it is newer than your BIOS before downloading. You can choose from the zip file and the .exe file. If you choose the zip BIOS file, please unzip the BIOS file onto a bootable USB device. Run the batch file using the format FLASH.BAT filename.rom from your bootable USB device to flash the BIOS. Then, your system will automatically reboot.



**Note:** The SPI BIOS chip used on this motherboard cannot be removed. Send your motherboard back to our RMA Department at Supermicro for repair. For BIOS Recovery instructions, please refer to the AMI BIOS Recovery Instructions posted at <http://www.supermicro.co>.

**Question: How do I update my BIOS under UEFI Shell?**



**Note:** We do not recommend that you update your BIOS if you are not experiencing a BIOS-related problem. If you need to update your BIOS, please follow the steps below to properly update your BIOS under UEFI Shell.

1. Download and save the BIOS update package to your computer.
2. Extract the files from the UEFI folder of the BIOS package to a USB stick.



**Note:** The USB stick doesn't have to be bootable; however, it has to be formatted with the FAT/FAT32 file system.

3. Insert the USB stick into a USB port, boot to the UEFI Built-In Shell, and type the following commands to start the BIOS update:

```
Shell> fs0:
```

```
fs0:\> cd UEFI
```

```
fs0:\UEFI> flash.nsh BIOSname#.###
```

---

4. The FLASH.NSH script will compare the Flash Descriptor Table (FDT) code in the new BIOS with the existing one in the motherboard:

**a. If a different FDT is found**

- A new file, STARTUP.NSH, will be created, and the system will automatically reboot in 10 seconds without you pressing any key. BIOS will be updated after the system reboots.
- You can also press <Y> to force an immediate system reboot to shorten the process. During system reboot, press the <F11> key to invoke the boot menu and boot into the build-in UEFI Shell. Your BIOS will be updated automatically.

**b. If the FDT is the same**

- BIOS update will be immediately performed without a system reboot initiated.

**Warning:** Do not shut down or reset the system while updating the BIOS to prevent possible system boot failure!)

5. Perform an A/C power cycle after the message indicating the BIOS update has completed.
6. Go to the BIOS setup utility, and restore the BIOS settings.

**Question: How do I handle the used battery?**

**Answer:** Please handle used batteries carefully. Do not damage the battery in any way; a damaged battery may release hazardous materials into the environment. Do not discard a used battery in the garbage or a public landfill. Please comply with the regulations set up by your local hazardous waste management agency to dispose of your used battery properly. Refer to Section 3-3 of this chapter.

### **3-5 Returning Merchandise for Service**

A receipt or copy of your invoice marked with the date of purchase is required before any warranty service will be rendered. You can obtain service by calling your vendor for a Returned Merchandise Authorization (RMA) number. When returning the motherboard to the manufacturer, the RMA number should be prominently displayed on the outside of the shipping carton, and the shipping package is mailed prepaid or hand-carried. Shipping and handling charges will be applied for all orders that must be mailed when service is complete. For faster service, You can also request a RMA authorization online (<http://www.supermicro.com/RmaForm/>).

This warranty only covers normal consumer use and does not cover damages incurred in shipping or from failure due to the alternation, misuse, abuse or improper maintenance of products.

During the warranty period, contact your distributor first for any product problems.

## Chapter 4

### BIOS

#### 4-1 Introduction

This chapter describes the AMI BIOS setup utility for the X10DRH-C/CT/i/iT. The ROM BIOS is stored in a Flash EEPROM and can be easily updated. This chapter describes the basic navigation of the AMI BIOS setup utility screens.

 **Note:** For AMI BIOS recovery, please refer to the UEFI BIOS Recovery Instructions in Appendix C.

#### Starting BIOS Setup Utility

To enter the AMI BIOS setup utility screens, press the <Delete> key while the system is booting up.

 **Note:** In most cases, the <Delete> key is used to invoke the AMI BIOS setup screen.

Each main BIOS menu option is described in this manual. The AMI BIOS setup menu screen has two main frames. The left frame displays all the options that can be configured. Grayed-out options cannot be configured. Options in blue can be configured by the user. The right frame displays the key legend. Above the key legend is an area reserved for a text message. When an option is selected in the left frame, it is highlighted in white. Often a text message will accompany it.

 **Note:** the AMI BIOS has default text messages built in. Supermicro retains the option to include, omit, or change any of these text messages.

The AMI BIOS setup utility uses a key-based navigation system called "hot keys." Most of the AMI BIOS setup utility "hot keys" can be used at any time during the setup navigation process. These keys include <F1>, <F4>, <Enter>, <Esc>, arrow keys, etc.

 **Note:** Options printed in **Bold** are default settings.

#### How To Change the Configuration Data

The configuration data that determines the system parameters may be changed by entering the AMI BIOS setup utility. This setup utility can be accessed by pressing <Del> at the appropriate time during system boot.

## How to Start the Setup Utility

Normally, the only visible Power-On Self-Test (POST) routine is the memory test. As the memory is being tested, press the <Delete> key to enter the main menu of the AMI BIOS setup utility. From the main menu, you can access the other setup screens. An AMI BIOS identification string is displayed at the left bottom corner of the screen, below the copyright message.

**Warning:** Do not upgrade the BIOS unless your system has a BIOS-related issue. Flashing the wrong BIOS can cause irreparable damage to the system. In no event shall Supermicro be liable for direct, indirect, special, incidental, or consequential damages arising from a BIOS update. If you have to update the BIOS, do not shut down or reset the system while the BIOS is updating to avoid possible boot failure.

## 4-2 Main Setup

When you first enter the AMI BIOS setup utility, you will enter the Main setup screen. You can always return to the Main setup screen by selecting the Main tab on the top of the screen. The Main BIOS setup screen is shown below.



The following Main menu items will be displayed:

### **System Date/System Time**

Use this option to change the system date and time. Highlight *System Date* or *System Time* using the arrow keys. Enter new values using the keyboard. Press the <Tab> key or the arrow keys to move between fields. The date must be entered in Day MM/DD/YYYY format. The time is entered in HH:MM:SS format.

 **Note:** The time is in the 24-hour format. For example, 5:30 P.M. appears as 17:30:00.

### **Supermicro X10DRH-C/i**

**Version:** This item displays the version of the BIOS ROM used in the system.

**Build Date:** This item displays the date when the version of the BIOS ROM used in the system was built.

### **Memory Information**

**Total Memory:** This item displays the total size of memory available in the system.

**Memory Speed:** This item displays the default speed of the memory modules installed in the system.

## 4-3 Advanced Setup Configurations

Use the arrow keys to select Advanced setup and press <Enter> to access the submenu items:

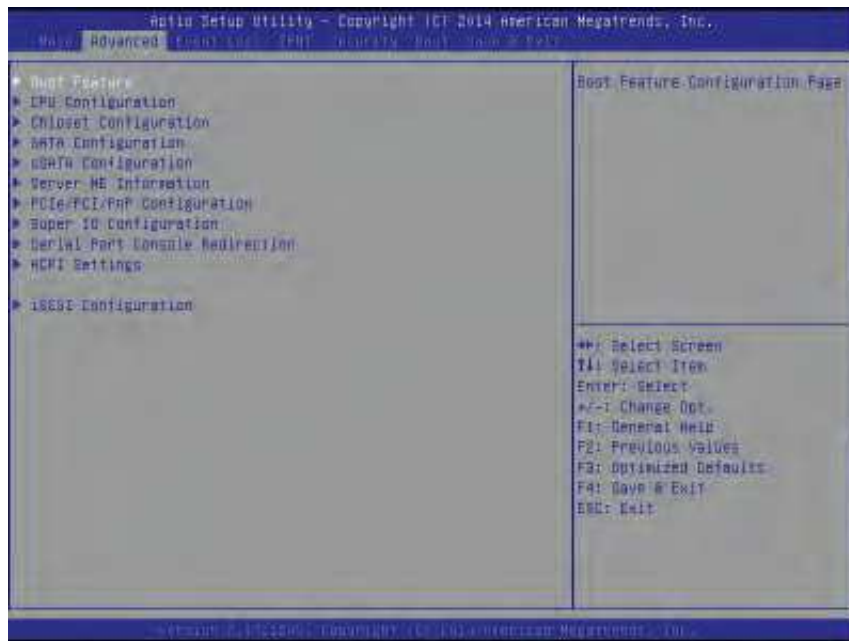

**Warning:** Take Caution when changing the Advanced settings. An incorrect value, a very high DRAM frequency or an incorrect BIOS timing setting may cause the system to malfunction. When this occurs, restore the setting to the manufacture default setting.

### ► Boot Feature

#### Quiet Boot

Use this feature to select the screen display between POST messages or the OEM logo at bootup. Select Disabled to display the POST messages. Select Enabled to display the OEM logo instead of the normal POST messages. The options are **Enabled** and Disabled.

#### AddOn ROM Display Mode

Use this item to set the display mode for the Option ROM. Select Keep Current to use the current AddOn ROM display setting. Select Force BIOS to use the Option ROM display mode set by the system BIOS. The options are **Force BIOS** and Keep Current.

#### Bootup Num-Lock State

Use this item to set the Power-on state for the Numlock key. The options are Off and **On**.

**Wait For 'F1' If Error**

Select Enabled to force the system to wait until the <F1> key is pressed if an error occurs. The options are Disabled and **Enabled**.

**Interrupt 19 Capture**

Interrupt 19 is the software interrupt that handles the boot disk function. When this item is set to Immediate, the ROM BIOS of the host adaptors will "capture" Interrupt 19 at bootup immediately and allow the drives that are attached to the host adaptors to function as bootable disks. If this item is set to Postponed, the ROM BIOS of the host adaptors will not capture Interrupt 19 immediately to allow the drives attached to the adaptors to function as bootable devices at bootup. The options are **Immediate** and Postponed.

**Re-try Boot**

Select EFI Boot to allow the BIOS to automatically reboot the system from an EFI boot device after its initial boot failure. Select Legacy Boot to allow the BIOS to automatically reboot the system from a Legacy boot device after its initial boot failure. The options are **Disabled**, Legacy Boot, and EFI Boot.

**Power Configuration****Watch Dog Function**

Select Enabled to allow the Watch Dog timer to reboot the system when it is inactive for more than 5 minutes. The options are Enabled and **Disabled**.

**Power Button Function**

This feature controls how the system shuts down when the power button is pressed. Select 4 Seconds Override for the user to power off the system after pressing and holding the power button for 4 seconds or longer. Select Instant Off to instantly power off the system as soon as the user presses the power button. The options are 4 Seconds Override and **Instant Off**.

**Restore on AC Power Loss**

Use this feature to set the power state after a power outage. Select Power Off for the system power to remain off after a power loss. Select Power On for the system power to be turned on after a power loss. Select Last State to allow the system to resume its last power state before a power loss. The options are Power On, Stay Off, and **Last State**.



## ► CPU Configuration

This submenu displays the following CPU information as detected by the BIOS. It also allows the user to configure CPU settings.

- Processor Socket
- Processor ID
- Processor Frequency
- Processor Max Ratio
- Processor Min Ratio
- Microcode Revision
- L1 Cache RAM
- L2 Cache RAM
- L3 Cache RAM
- CPU 1 Version
- CPU 2 Version

### **Clock Spread Spectrum**

Select Enabled to allow the BIOS to monitor and attempt to reduce the level of Electromagnetic Interference caused by the components whenever needed. The options are **Disabled** and Enabled.

### **Hyper-Threading (All)**

Select Enable to support Intel's Hyper-threading Technology to enhance CPU performance. The options are **Enable** and Disable.

### **Cores Enabled**

This feature allows the user to determine the number of CPU cores to enable. Enter "0" to enable all cores. The default setting is **0**, which enables all CPU cores in the system.

### **Execute Disable Bit (Available if supported by the OS & the CPU)**

Select Enable for Execute Disable Bit Technology support, which will allow the processor to designate areas in the system memory where an application code can execute and where it cannot, thus preventing a worm or a virus from flooding

illegal codes to overwhelm the processor to damage the system during an attack. The options are **Enable** and Disable. (Refer to Intel's and Microsoft's websites for more information.)

### **PPIN Control**

Select Unlock/Enable to use the Protected-Processor Inventory Number (PPIN) control in the system. The options are **Unlock/Enable** and Unlock/Disable.

### **Hardware Prefetcher (Available when supported by the CPU)**

If set to Enable, the hardware prefetcher will prefetch streams of data and instructions from the main memory to the L2 cache to improve CPU performance. The options are Disable and **Enable**.

### **Adjacent Cache Prefetch (Available when supported by the CPU)**

Select Enable for the CPU to prefetch both cache lines for 128 bytes as comprised. Select Disable for the CPU to prefetch both cache lines for 64 bytes. The options are Disable and **Enable**.

 **Note:** Please reboot the system for changes on this setting to take effect. Please refer to Intel's website for detailed information.

### **DCU (Data Cache Unit) Streamer Prefetcher (Available when supported by the CPU)**

If set to Enable, the DCU Streamer prefetcher will prefetch data streams from the cache memory to the DCU (Data Cache Unit) to speed up data accessing and processing to enhance CPU performance. The options are Disable and **Enable**.

### **DCU IP Prefetcher**

If set to Enable, the IP prefetcher in the DCU (Data Cache Unit) will prefetch IP addresses to improve network connectivity and system performance. The options are **Enable** and Disable.

### **Direct Cache Access (DCA)**

Select Enable to use Intel DCA (Direct Cache Access) Technology to improve the efficiency of data transferring and accessing. The options are **Auto**, Enable, and Disable.

### **X2 APIC (Advanced Programmable Interrupt Controller)**

Based on Intel's Hyper-Threading architecture, each logical processor (thread) is assigned 256 APIC IDs (APIDs) in 8-bit bandwidth. When this feature is set to Enable, the APIC ID will expand(X2) from 8 bits to 16 bits to provide 512 APIDs to each thread for CPU performance enhancement. The options are **Disable** and Enable.

### **AES-NI**

Select Enable to use the Intel Advanced Encryption Standard (AES) New Instructions (NI) to ensure data security. The options are **Enable** and Disable.

### **Intel Virtualization Technology**

Select Enable to use Intel Virtualization Technology support for Direct I/O VT-d support by reporting the I/O device assignments to the VMM (Virtual Machine Monitor) through the DMAR ACPI tables. This feature offers fully-protected I/O resource sharing across Intel platforms, providing greater reliability, security and availability in networking and data-sharing. The options are **Enable** and Disable.

## **► Advanced Power Management Configuration**

### **Advanced Power Management Configuration**

#### **Power Technology**

Select Energy Efficient to support power-saving mode. Select Custom to customize system power settings. Select Disabled to disable power-saving settings. The options are Disable, **Energy Efficient**, and Custom.

### **► CPU P State Control (Available when Power Technology is set to Custom)**

#### **EIST (P-States)**

EIST (Enhanced Intel SpeedStep Technology) allows the system to automatically adjust the processor voltage and core frequency to reduce power consumption and heat dissipation. The options are Disable and **Enable**.

#### **Turbo Mode**

Select Enabled to use the Turbo Mode to boost system performance. The options are **Enable** and Disable.

#### **P-State Coordination**

This feature is used to change the P-state (Power-Performance State) coordination type. P-state is also known as "SpeedStep" for Intel processors. Select HW\_ALL to change the P-state coordination type for hardware components only. Select SW\_ALL to change the P-state coordination type for all software installed in the system. Select SW\_ANY to change the P-state coordination type for a software program in the system. The options are **HW\_All**, SW\_ALL, and SW\_ANY.

## ► CPU C State Control (Available when Power Technology is set to Custom)

### Package C State limit

Use this item to set the limit on the C-State package register. The options are C0/1 state, C2 state, C6 (non-Retention) state, **C6 (Retention) state**, and No Limit.

### CPU C3 Report

Select Enable to allow the BIOS to report the CPU C3 State (ACPI C2) to the operating system. During the CPU C3 State, the CPU clock generator is turned off. The options are Enable and **Disable**.

### CPU C6 Report (Available when Power Technology is set to Custom)

Select Enable to allow the BIOS to report the CPU C6 state (ACPI C3) to the operating system. During the CPU C6 state, power to all cache is turned off. The options are **Enable** and Disable.

### Enhanced Halt State (C1E)

Select Enabled to use Enhanced Halt-State technology, which will significantly reduce CPU power consumption by reducing CPU clock cycles and voltages during a Halt-state. The options are Disable and **Enable**.

## ► CPU T State Control (Available when Power Technology is set to Custom)

### ACPI (Advanced Configuration Power Interface) T-States

Select Enable to support CPU throttling by the operating system to reduce power consumption. The options are **Enable** and Disable.

## ► Socket RAPL (Running Average Power Limit) Config. (Configuration)

### FAST\_RAPL\_NSTRIKE\_PL2\_DUTY\_CYCLE

This feature displays the value of the item above within the range between 25 (10%) and 64 (25%). The default setting is **64**.

### Turbo Power Limit Lock

Select Enable to set the power use limit for the machine when it is running in the turbo mode. The options are Enable and **Disable**.

### **Long Pwr (Power) Limit Ovrd (Override)**

Select Enable to support long-term power limit override. If this feature is disabled, BIOS will set the default value. The options are **Enable** and Disable.

### **Long Dur (Duration) Power Limit**

This item displays the power limit set by the user during which long duration power is maintained. The default setting is **0**.

### **Long Dur (Duration) Time Window**

Use this item to set the time window value (in seconds) over which the TDP (Thermal Design Point) should be maintained. The default setting is **1**, which will allow the value to be automatically programmed by the system.

### **Pkg (Package) Clmp (Clamping) Limit1**

Use this item to set the limit on power performance states for the runtime processor, with P0 being the state with the highest frequency (clock speed) and power (consumption), and P1, a step lower in performance than P0, with its frequency and voltage scaled back a notch. The options are Between P1/P0 and **Below P1**.

### **Short Dur (Duration) Pwr (Power) Limit En (Enable)**

Select Enable to support Short Duration Power Limit (Power Limit 2). The options are **Enable** and Disable.

### **Short Dur (Duration) Pwr (Power) Limit**

This item displays the time period during which short duration power is maintained. The default setting is **0**.

### **Pkg (Package) Clmp (Clamping) Lim2**

Use this item to set the limit on power performance states for the processor operating in turbo mode, with P0 being the state with the highest frequency (clock speed) and power (consumption), and P1, a step lower in performance than P0, with its frequency and voltage scaled back a notch. The options are Between P1/P0 and **Below P1**.

## **► DRAM RAPL (Running Average Power Limit) Configuration**

### **DRAM RAPL (Running Average Power Limit) Baseline**

Use this item to set the run-time power-limit baseline for DRAM modules. The options are Disable, DRAM RAPL Mode 0, and **DRAM RAPL Mode 1**.

**Override BW\_LIMIT\_TF (BW\_limit\_tf )**

This feature allows the user to turn off the "Override BW\_Limit\_TF (Time Frame)" setting when the item--the "Running Average Power Limit for DRAM modules" (DRAM RAPL) is set to Enabled so that the DRAM RAPL setting can work properly. The default setting is 1.

**DRAM RAPL (Running Average Power Limit) Extended Range**

Select Enable to extend the RAPL range for the DRAM modules. The options are Disable and **Enable**.

**► Chipset Configuration**

**Warning!** Please set the correct settings for the items below. A wrong configuration setting may cause the system to become malfunction.

**► North Bridge**

This feature allows the user to configure the settings for the Intel North Bridge.

**► IIO Configuration****EV DFX (Device Function On-Hide) Features**

When this feature is set to Enable, the EV\_DFX Lock Bits that are located on a processor will always remain clear during electric tuning. The options are **Disable** and Enable.

**► IIO0 Configuration****IOU2 (IIO PCIe Port 1)**

This item configures the PCI-E port Bifuraction setting for a PCI-E port specified by the user. The options are x4x4, **x8**, and Auto.

**IOU0 (IIO PCIe Port 2)**

This item configures the PCI-E port Bifuraction setting for a PCI-E port specified by the user. The options are x4x4x4x4, x4x4x8, x8x4x4, **x8x8**, x16, and Auto.

**IOU1 (IIO1 PCIe Port 3)**

This item configures the PCI-E port Bifuraction setting for a PCI-E port specified by the user. The options are x4x4x4x4, x4x4x8, x8x4x4, **x8x8**, x16, and Auto..

### No PCIe Port Active ECO (Engineer Change Order)

This feature provides a work-around solution when there is no active PCI device detected by the BIOS. The options are **PCU Squelch Exit Ignore Option** and Reset the SQ FLOP by CSR Option.

### ► Socket 0 PCIeD00F0 - Port 0/DMI

#### Link Speed

This item configures the link speed of a PCI-E port specified by the user. The options are Gen 1 (Generation 1) (2.5 GT/s), Gen 2 (Generation 2) (5 GT/s), and **Auto**.

#### PCI-E Port DeEmphasis

This item configures the De-Emphasis Control (LANKCON2 [6]) setting for this computer. The options are **-6.0 dB** and -3.5 dB.

The following items will be display:

- PCI-E Port Link Status
- PCI-E Port Link Max
- PCI-E Port Link Speed

#### PCI-E Port L0s Exit Latency

Use this item to set the length of time required for the port specified by the user to complete the transition from L0s to L0. The default setting is **4uS - 8uS**.

#### PCI-E Port L1 Exit Latency

Use this item to set the length of time required for the port specified by the user to complete the transition from L1 to L0. The default setting is <1uS, 1uS - 2uS, 2uS - 4uS, 4uS - 8uS, **8uS - 16uS**, 16uS - 32uS, 32uS - 64uS, and >64uS.

#### Fatal Err (Error) Over

Select Enable to force fatal error prorogation to the IIO core error logic for the port specified by the user. The options are **Disable** and Enable.

#### Non-Fatal Err (Error) Over

Select Enable to force non-fatal error prorogation to the IIO core error logic for the port specified by the user. The options are **Disable** and Enable.

#### Corr Err (Correctable Error) Over

Select Enable to force correctable error prorogation to the IIIO core error logic for the port specified by the user. The options are **Disable** and Enable.

---

### **L0s Support**

When this item is set to Disable, I/O will not put its transmitter in the L0s state. The default setting is **Disable**.

### **►Socket 0 PCIeD01F0 - Port 1A/Socket 0 PCIeD02F0 - Port 2A/Socket 0 PCIeD20F2 - Port 2C/Socket 0 PCIeD03F0 - Port 3A/Socket 0 PCIeD03F2 - Port 3C**

#### **PCI-E Port**

Select Enable to enable the PCI-E port specified by the user. The options are **Auto**, Enable, and Disable.

#### **Hot Plug Capable**

Select Enable to enable hot-plugging support for the PCI-E port specified by the user to allow the user to replace the device installed on the port without shutting down the system. The options are **Disable** and Enable.

#### **PCI-E Port Link**

Select Disable to disable the link that is not involved in training activities, but its CFG is still active. The options are **Enable** and Disable.

#### **Link Speed**

Use this item to select the link speed for the PCI-E port specified by the user. The options are GEN1 (2.5 GT/s), GEN2 (5 GT/s), GEN3 (8 GT/s), and **Auto**.

#### **PCI-E Port DeEmphasis**

Use this item to select the De-Emphasis control setting for a PCI-E port specified by the user. The options are **-6.0 dB** and -3.5 dB.

The following items will be display:

- PCI-E Port Link Status
- PCI-E Port Link Max
- PCI-E Port Link Speed

#### **PCI-E Port L0s Exit Latency**

Use this item to set the length of time required for the port specified by the user to complete the transition from L0s to L0. The default setting is **4uS - 8uS**.



### **PCI-E Port L1 Exit Latency**

Use this item to set the length of time required for the port specified by the user to complete the transition from L1 to L0. The default setting is <1uS, 1uS - 2uS, 2uS - 4uS, 4uS - 8uS, **8uS - 16uS**, 16uS - 32uS, 32uS - 64uS, and >64uS.

### **Fatal Err (Error) Over**

Select Enable to force fatal error prorogation to the IIO core error logic for the port specified by the user. The options are **Disable** and Enable.

### **Non-Fatal Err (Error) Over**

Select Enable to force non-fatal error prorogation to the IIO core error logic for the port specified by the user. The options are **Disable** and Enable.

### **Corr Err (Correctable Error) Over**

Select Enable to force correctable error prorogation to the IIIO core error logic for the port specified by the user. The options are **Disable** and Enable.

### **L0s Support**

When this item is set to Disable, IIO will not put its transmitter in the L0s state. The default setting is **Disable**.

### **PM ACPI Support**

Select Enable to generate an \_HPGPE message on a PM ACPI event. Select Disable to generate an MSI message. The options are **Disable** and Enable.

### **Gen3 (Generation 3) Eq (Equalization) Mode**

Use this item to set the "Adaptive Equalization" mode for PCI-E Generation 3 devices. The options are **Auto**, Enable Phase 0, 1, 2, 3; Disable Phase 0, 1, 2, 3; Enable Phase 1 Only, Enable Phase 0, 1 Only, Enable MMM Offset West, and Advanced.

### **Gen3 (Generation 3) Spec (Specifics) Mode**

Use this item to set the Specifics mode for PCI-E Generation 3 devices. The options are **Auto**, 0.70 July, 0.70 Sept and 071 Sept.

### **Gen3 (Generation 3) Phase2 Mode**

Use this item to set the PCI-E Generation 3 Phase 2 mode. The options are **Hardware Adaptive** and Manual.

### **Gen3 (Generation 3) DN TX Preset**

Use this item to set the Preset mode for PCI-E Gen3 downstream transmitting (TX) from the master device to a slave device. The options are **Auto**, P0 (-6.0/0.0 dB), P1 (-3.5/0.0 dB), P2 (-4.5/0.0 dB), P3 (-2.5/0.0 dB), P4 (0.0/0.0

dB), P5 (0.0/2.0 dB), P6 (0.0/2.5 dB), P7 (-6.0 /3.5 dB), P8 (-3.5/3.5 dB), and P9 (0.0/3.5 dB).

### **Gen3 (Generation 3) DN RX Preset Hint**

Use this item to set the Preset Hint mode for PCI-E Gen3 downstream receiving (RX) from the master device to a slave device. The options are **Auto**, P0 (-6.0 dB), P1 (-7.0 dB), P2 (-8.0 dB), P3 (-9.0 dB), P4 (-10.0 dB) P5 (-11.0 dB), and P6 (-12.0 dB).

### **Gen3 (Generation 3) Up TX Preset**

Use this item to set the Preset mode for PCI-E Gen3 upstream transmitting (TX) from a slave device to the master device. The options are **Auto**, P0 (-6.0/0.0 dB), P1 (-3.5/0.0 dB), P2 (-4.5/0.0 dB), P3 (-2.5/0.0 dB), P4 (0.0/0.0 dB), P5 (0.0/2.0 dB), P6 (0.0/2.5 dB), P7 (-6.0/3.5 dB), P8 (-3.5/3.5 dB), and P9 (0.0/3.5 dB).

### **Non-Transparent Bridge PCIe Port Definition (Available on the Socket 0 PCIeD03F0 - Port 3A only)**

Select Transparent Bridge to enable Transparent Bridge support for the PCI-E port specified by the user. Please do not select NTB-RP for a legacy IIO device. The options are **Transparent Bridge**, NTB to NTB, and NTB to RP.

### **Hide Port?**

Select Yes to hide the PCI-E port specified from the OS. The options are **No** and Yes.

This feature allows the user to configure the settings for the Intel North Bridge.

## **► IIO1 Configuration**

### **IOU2 (IIO PCIe Port 1)**

This item configures the PCI-E port Bifuraction setting for a PCI-E port specified by the user. The options are x4x4, **x8**, and Auto.

### **IOU0 (IIO PCIe Port 2)**

This item configures the PCI-E port Bifuraction setting for a PCI-E port specified by the user. The options are x4x4x4x4, x4x4x8, x8x4x4, **x8x8**, x16, and Auto.

### **IOU1 (IIO1 PCIe Port 3)**

This item configures the PCI-E port Bifuraction setting for a PCI-E port specified by the user. The options are x4x4x4x4, x4x4x8, x8x4x4, x8x8, **x16**, and Auto.

### No PCIe Port Active ECO (Engineer Change Order)

This feature provides a work-around solution when there is no active PCI device detected by the BIOS. The options are **PCU Squelch Exit Ignore Option** and **Reset the SQ FLOP by CSR Option**.

### ► Socket 1 PCIeD00F0 - Port 0/DMI/Socket 1 PCIeD01F0 - Port 1A/Socket 1 PCIeD02F0 - Port 2A/Socket 1 PCIeD20F2 - Port 2C/Socket 1 PCIeD03F0 - Port 3A

#### PCI-E Port

Select Enable to enable the PCI-E port specified by the user. The options are **Auto**, **Enable**, and **Disable**.

#### Hot Plug Capable

Select Enable to enable hot-plugging support for the PCI-E port specified by the user to allow the user to replace the device installed on the port without shutting down the system. The options are **Disable** and **Enable**.

#### PCI-E Port Link

Select Disable to disable the link that is not involved in training activities, but its CFG is still active. The options are **Enable** and **Disable**.

#### Link Speed

Use this item to select the link speed for the PCI-E port specified by the user. The options are GEN1 (2.5 GT/s), GEN2 (5 GT/s), GEN3 (8 GT/s), and **Auto**.

#### PCI-E Port DeEmphasis

Use this item to select the De-Emphasis control setting for a PCI-E port specified by the user. The options are **-6.0 dB** and **-3.5 dB**.

The following items will be display:

- PCI-E Port Link Status
- PCI-E Port Link Max
- PCI-E Port Link Speed

#### PCI-E Port L0s Exit Latency

Use this item to set the length of time required for the port specified by the user to complete the transition from L0s to L0. The default setting is **4uS - 8uS**.

**PCI-E Port L1 Exit Latency**

Use this item to set the length of time required for the port specified by the user to complete the transition from L1 to L0. The default setting is <1uS, 1uS - 2uS, 2uS - 4uS, 4uS - 8uS, **8uS - 16uS**, 16uS - 32uS, 32uS - 64uS, and >64uS.

**Fatal Err (Error) Over**

Select Enable to force fatal error prorogation to the IIO core error logic for the port specified by the user. The options are **Disable** and Enable.

**Non-Fatal Err (Error) Over**

Select Enable to force non-fatal error prorogation to the IIO core error logic for the port specified by the user. The options are **Disable** and Enable.

**Corr Err (Correctable Error) Over**

Select Enable to force correctable error prorogation to the IIO core error logic for the port specified by the user. The options are **Disable** and Enable.

**L0s Support**

When this item is set to Disable, IIO will not put its transmitter in the L0s state. The default setting is **Disable**.

**PM ACPI Support**

Select Enable to generate an \_HPGPE message on a PM ACPI event. Select Disable to generate an MSI message. The options are **Disable** and Enable.

**Gen3 (Generation 3) Eq (Equalization) Mode**

Use this item to set the "Adaptive Equalization" mode for PCI-E Generation 3 devices. The options are **Auto**, Enable Phase 0, 1, 2, 3; Disable Phase 0, 1, 2, 3; Enable Phase 1 Only, Enable Phase 0, 1 Only, Enable MMM Offset West, and Advanced.

**Gen3 (Generation 3) Spec (Specifics) Mode**

Use this item to set the Specifics mode for PCI-E Generation 3 devices. The options are **Auto**, 0.70 July, 0.70 Sept and 071 Sept.

**Gen3 (Generation 3) Phase2 Mode**

Use this item to set the PCI-E Generation 3 Phase 2 mode. The options are **Hardware Adaptive** and Manual.

**Gen3 (Generation 3) DN TX Preset**

Use this item to set the Preset mode for PCI-E Gen3 downstream transmitting (TX) from the master device to a slave device. The options are **Auto**, P0 (-6.0/0.0 dB), P1 (-3.5/0.0 dB), P2 (-4.5/0.0 dB), P3 (-2.5/0.0 dB), P4 (0.0/0.0

---

dB), P5 (0.0/2.0 dB), P6 (0.0/2.5 dB), P7 (-6.0 /3.5 dB), P8 (-3.5/3.5 dB), and P9 (0.0/3.5 dB).

### **Gen3 (Generation 3) DN RX Preset Hint**

Use this item to set the Preset Hint mode for PCI-E Gen3 downstream receiving (RX) from the master device to a slave device. The options are **Auto**, P0 (-6.0 dB), P1 (-7.0 dB), P2 (-8.0 dB), P3 (-9.0 dB), P4 (-10.0 dB) P5 (-11.0 dB), and P6 (-12.0 dB).

### **Gen3 (Generation 3) Up TX Preset**

Use this item to set the Preset mode for PCI-E Gen3 upstream transmitting (TX) from a slave device to the master device. The options are **Auto**, P0 (-6.0/0.0 dB), P1 (-3.5/0.0 dB), P2 (-4.5/0.0 dB), P3 (-2.5/0.0 dB), P4 (0.0/0.0 dB), P5 (0.0/2.0 dB), P6 (0.0/2.5 dB), P7 (-6.0/3.5 dB), P8 (-3.5/3.5 dB), and P9 (0.0/3.5 dB).

### **Non-Transparent Bridge PCIe Port Definition (Available on the Socket 1 PCIeD03F0 - Port 3A only)**

Select Transparent Bridge to enable Transparent Bridge support for the PCI-E port specified by the user. Please do not select NTB-RP for a legacy IIO device. The options are **Transparent Bridge**, NTB to NTB, and NTB to RP.

### **Hide Port?**

Select Yes to hide the PCI-E port specified from the OS. The options are **No** and Yes.

## **► IOAT (Intel® IO Acceleration) Configuration**

### **Enable IOAT**

Select Enable to enable Intel I/OAT (I/O Acceleration Technology) support, which significantly reduces CPU overhead by leveraging CPU architectural improvements and freeing the system resource for other tasks. The options are **Enable** and Disable.

### **No Snoop**

Select Enable to support no-snoop mode for each CB device. The options are **Disable** and Enable.

### **Relaxed Ordering**

Select Enable to enable Relaxed Ordering support which will allow certain transactions to violate the strict-ordering rules of PCI bus for a transaction to be completed prior to other transactions that have already been enqueued. The options are **Disable** and Enable.

## ► Intel VT for Directed I/O (VT-d)

### Intel® VT for Directed I/O (VT-d)

Select Enable to use Intel Virtualization Technology for Direct I/O VT-d support by reporting the I/O device assignments to the VMM (Virtual Machine Monitor) through the DMAR ACPI tables. This feature offers fully-protected I/O resource sharing across Intel platforms, providing greater reliability, security and availability in networking and data-sharing. The options are **Enable** and Disable.

### Interrupt Remapping

Select Enable for Interrupt Remapping support to enhance system performance. The options are **Enable** and Disable.

## ► QPI (Quick Path Interconnect) Configuration

### ► QPI General Configuration

#### ► QPI Status

The following information will display:

- Number of CPU
- Number of IIO
- Current QPI Link Speed
- Current QPI Link Frequency
- QPI Global MMIO Low Base/Limit
- QPI Global MMIO High Base/Limit
- QPI PCIe Configuration Base/Size

#### Link Frequency Select

Use this item to select the desired frequency for QPI Link connections. The options are 6.4GB/s, 8.0GB/s, 9.6GB/s, **Auto**, and Auto Limited.

#### Link L0p Enable

Select Enable for Link L0p support to reduce power consumption. The options are **Enable** and Disable.

### **Link L1 Enable**

Select Enable for Link L1 support to reduce power consumption. The options are **Enable** and Disable.

### **COD Enable (Available when the OS and the CPU support this feature)**

Select Enable for Cluster-On-Die support to enhance system performance in cloud computing. The options are Enable and **Disable**.

### **Early Snoop (Available when the OS and the CPU support this feature)**

Select Enable for Early Snoop support to enhance system performance. The options are Enable, Disable, and **Auto**.

### **Isoc Mode**

Select Enable for Isochronous support to meet QoS (Quality of Service) requirements. This feature is especially important for Intel Virtualization Technology. The options are Enable and **Disable**.

## **► Memory Configuration**

This submenu allows the user to configure Integrated Memory Controller (IMC) settings.

### **Enforce POR**

Select Enabled to enforce POR restrictions on DDR4 frequency and voltage programming. The options are **Enabled** and Disabled.

### **Memory Frequency**

Use this feature to set the maximum memory frequency for onboard memory modules. The options are **Auto**, 1333, 1400, 1600, 1800, 1867, 2000, 2133, 2200, 2400, 2600, 2667, 2800, 2993, 3000, 3200, and Reserved (Do not select Reserved).

### **Data Scrambling**

Select Enabled to enable data scrambling to enhance system performance and data integrity. The options are **Auto**, Disabled and Enabled.

### **DRAM RAPL (Running Average Power Limit) Baseline**

Use this feature to set the run-time power-limit baseline for DRAM modules. The options are Disable, DRAM RAPL Mode 0, and **DRAM RAPL Mode 1**.

### **Set Throttling Mode**

Throttling improves CPU reliability and reduces power consumption via automatic-voltage control during CPU idle states. The options are Disabled and **CLTT** (Closed Loop Thermal Throttling).

### **A7 Mode**

Select Enable to support the A7 (Addressing) mode to improve memory performance. The options are **Enable** and Disable.

### **► DIMM Information**

This item displays the status of a DIMM module as detected by the AMI BIOS.

- P1 DIMMA1
- P2 DIMME1

### **► Memory RAS (Reliability\_Availability\_Serviceability) Configuration**

Use this submenu to configure the following Memory RAS settings.

#### **RAS Mode**

When Disable is selected, RAS is not supported. When Mirror is selected, the motherboard maintains two identical copies of all data in memory for data backup. When Lockstep is selected, the motherboard uses two areas of memory to run the same set of operations in parallel to boost performance. The options are **Disable**, Mirror, and Lockstep Mode.

#### **Memory Rank Sparing**

Select Enable to enable memory-sparing support for memory ranks to improve memory performance. The options are **Disabled** and Enabled.

#### **Patrol Scrub**

Patrol Scrubbing is a process that allows the CPU to correct correctable memory errors detected on a memory module and send the correction to the requestor (the original source). When this item is set to Enable, the IO hub will read and write back one cache line every 16K cycles, if there is no delay caused by internal processing. By using this method, roughly 64 GB of memory behind the IO hub will be scrubbed every day. The options are **Enable** and Disable.



### **Patrol Scrub Interval**

This feature allows you to decide how many hours the system should wait before the next complete patrol scrub is performed. Use the keyboard to enter a value from 0-24. The Default setting is **24**.

### **Demand Scrub**

Demand Scrubbing is a process that allows the CPU to correct correctable memory errors found on a memory module. When the CPU or I/O issues a demand-read command, and the read data from memory turns out to be a correctable error, the error is corrected and sent to the requestor (the original source). Memory is updated as well. Select Enable to use Demand Scrubbing for ECC memory correction. The options are **Enable** and Disable.

### **Device Tagging**

Select Enable to support device tagging. The options are **Disable** and Enable.

## **►South Bridge Configuration**

The following South Bridge information will display:

### **►USB Configuration**

- USB Module Version
- USB Devices

### **Legacy USB Support**

Select Enabled to support onboard legacy USB devices. Select Auto to disable legacy support if there are no legacy USB devices present. Select Disabled to have all USB devices available for EFI applications only. The options are **Enabled**, Disabled and Auto.

### **XHCI Hand-Off**

This is a work-around solution for operating systems that do not support XHCI (Extensible Host Controller Interface) hand-off. The XHCI ownership change should be claimed by the XHCI driver. The settings are **Enabled** and Disabled.

### **EHCI Hand-Off**

This item is for operating systems that do not support Enhanced Host Controller Interface (EHCI) hand-off. When this item is enabled, EHCI ownership change will be claimed by the EHCI driver. The settings are Enabled and **Disabled**.

**Port 60/64 Emulation**

Select Enabled to support I/O port 60h/64h emulation, which will provide complete legacy USB keyboard support for the operating systems that do not support legacy USB devices. The options are Disabled and **Enabled**.

**USB 3.0 Support**

Select Enabled for USB 3.0 support. The options are Smart Auto, Auto, Enabled, and **Disabled**.

**EHCI1**

Select Enabled to enable EHCI (Enhanced Host Controller Interface) support on USB 2.0 connector #1 (-at least one USB 2.0 connector should be enabled for EHCI support.) The options are Disabled and **Enabled**.

**EHCI2**

Select Enabled to enable EHCI (Enhanced Host Controller Interface) support on USB 2.0 connector #2 (-at least one USB 2.0 connector should be enabled for EHCI support.) The options are Disabled and **Enabled**.

## ►SATA Configuration

When this submenu is selected, AMI BIOS automatically detects the presence of the SATA devices that are supported by the Intel PCH chip and displays the following items:

### SATA Controller

Select Enabled to enable the onboard SATA controller supported by the Intel PCH chip. The options are **Enabled** and Disabled.

### Configure SATA as

Select IDE to configure a SATA drive specified by the user as an IDE drive. Select AHCI to configure a SATA drive specified by the user as an AHCI drive. Select RAID to configure a SATA drive specified by the user as a RAID drive. The options are IDE, **AHCI**, and RAID.

*\*If the item above "Configure SATA as" is set to AHCI, the following items will display:*

### Support Aggressive Link Power Management

When this item is set to Enabled, the SATA AHCI controller manages the power usage of the SATA link. The controller will put the link to a low power state when the I/O is inactive for an extended period of time, and the power state will return to normal when the I/O becomes active. The options are **Enabled** and Disabled.

### SATA Port 0~ Port 5

This item displays the information of a SATA device installed on the SATA port specified by the user.

- Model number of drive and capacity
- Software Preserve

### Port 0~ Port 5

Select Enabled to enable a SATA port specified by the user. The options are Disabled and **Enabled**.

### Spin Up Device

On an edge detect from 0 to 1, set this item to allow the PCH to initialize the device. The options are Enabled and **Disabled**.

### SATA Device Type

Use this item to specify if the SATA port specified by the user should be connected to a Solid State drive or a Hard Disk Drive. The options are **Hard Disk Drive** and Solid State Drive.

*\*If the item above "Configure SATA as" is set to IDE, the following items will display:*

#### **SATA Port 0~ Port 5**

This item displays the information of a SATA device installed on the SATA port specified by the user.

- Software Preserve

#### **SATA Device Type (Available when a SATA port is detected)**

Use this item to specify if the SATA port specified by the user should be connected to a Solid State drive or a Hard Disk Drive. The options are **Hard Disk Drive** and Solid State Drive.

*\*If the item above "Configure SATA as" is set to RAID, the following items will display:*

#### **Support Aggressive Link Power Management**

When this item is set to Enabled, the SATA AHCI controller manages the power usage of the SATA link. The controller will put the link to a low power state when the I/O is inactive for an extended period of time, and the power state will return to normal when the I/O becomes active. The options are **Enabled** and Disabled.

#### **SATA RAID Option ROM/UEFI Driver**

Select EFI to load the EFI driver for system boot. Select Legacy to load a legacy OPROM for system boot. The options are Disabled, EFI, and **Legacy**.

#### **SATA/sSATA RAID Boot Select**

Select SATA Controller to boot the system from a SATA RAID device. Select sSATA Controller to boot the system from a sSATA RAID device. Select Both to boot the system either from a SATA RAID device or from an sSATA RAID device. Please note that the option-Both is not supported by the Windows Server 2012/R2 OS. The options are None, Both, SATA Controller, and **sSATA Controller**.

#### **Serial ATA Port 0~ Port 5**

This item displays the information of a SATA device installed on the SATA port specified by the user.

- Model number of drive and capacity
- Software Preserve

**Port 0~ Port 5**

Select Enabled to enable a SATA port specified by the user. The options are Disabled and **Enabled**.

**Spin Up Device**

On an edge detect from 0 to 1, set this item to allow the PCH to start a COMRESET initialization to the device. The options are Enabled and **Disabled**.

**SATA Device Type**

Use this item to specify if the SATA port specified by the user should be connected to a Solid State drive or a Hard Disk Drive. The options are **Hard Disk Drive** and Solid State Drive.

**►sSATA Configuration**

When this submenu is selected, AMI BIOS automatically detects the presence of the SATA devices that are supported by the PCH-sSATA controller and displays the following items:

**sSATA Controller**

This item enables or disables the onboard SATA controller supported by the Intel PCH-sSATA controller. The options are **Enabled** and Disabled.

**Configure sSATA as**

Select IDE to configure an sSATA drive specified by the user as an IDE drive. Select AHCI to configure an sSATA drive specified by the user as an AHCI drive. Select RAID to configure an sSATA drive specified by the user as a RAID drive. The options are IDE, **AHCI**, and RAID.

*\*If the item above "Configure sSATA as" is set to AHCI, the following items will display:*

**Support Aggressive Link Power Management**

When this item is set to Enabled, the SATA AHCI controller manages the power usage of the SATA link. The controller will put the link to a low power state when the I/O is inactive for an extended period of time, and the power state will return to normal when the I/O becomes active. The options are **Enabled** and Disabled.

**sSATA Port 0~ Port 3**

This item displays the information detected on the installed on the sSATA port. specified by the user.

- Model number of drive and capacity

**sSATA Port 0~ Port 3**

Select Enabled to enable an sSATA port specified by the user. The options are Disabled and **Enabled**.

**Spin Up Device**

On an edge detect from 0 to 1, set this item to allow the PCH to start a COMRESET initialization to the device. The options are Enabled and **Disabled**.

**Device Type**

Use this item to specify if the sSATA port specified by the user should be connected to a Solid State drive or a Hard Disk Drive. The options are **Hard Disk Drive** and Solid State Drive.

*\*If the item above "Configure sSATA as" is set to IDE, the following items will display:*

**sSATA Port 0~ Port 3**

This item indicates that an sSATA port specified by the user is installed (present) or not.

**sSATA Device Type (Available when a sSATA port is detected)**

Use this item to specify if the sSATA port specified by the user should be connected to a Solid State drive or a Hard Disk Drive. The options are **Hard Disk Drive** and Solid State Drive.

*\*If the item above "Configure sSATA as" is set to RAID, the following items will display:*

**Support Aggressive Link Power Management**

When this item is set to Enabled, the SATA AHCI controller manages the power usage of the sSATA link. The controller will put the link to a low power state when the I/O is inactive for an extended period of time, and the power state will return to normal when the I/O becomes active. The options are **Enabled** and Disabled.

**sSATA RAID Option ROM/UEFI Driver**

Select EFI to load the EFI driver for system boot. Select Legacy to load a legacy OPROM for system boot. The options are Disabled, EFI, and **Legacy**.

**SATA/sSATA RAID Boot Select**

Select SATA Controller to boot the system from a SATA RAID device. Select sSATA Controller to boot the system from a sSATA RAID device. Select Both to boot the system either from a SATA RAID device or from an sSATA RAID device. Please note that the option-Both is not supported by the Windows Server 2012/R2 OS. The options are None, Both, SATA Controller, and **sSATA Controller**.

---

### **sSATA Port 0~ Port 3**

Select Enabled to enable an sSATA port specified by the user. The options are Disabled and Enabled.

### **Spin Up Device**

On an edge detect from 0 to 1, set this item to allow the PCH to start a COMRE-SET initialization to the device. The options are Enabled and **Disabled**.

### **Device Type**

Use this item to specify if the sSATA port specified by the user should be connected to a Solid State drive or a Hard Disk Drive. The options are **Hard Disk Drive** and Solid State Drive.

## **► Server ME (Management Engine) Configuration**

This feature displays the following system ME configuration settings.

- General ME Configuration
- Operational Firmware Version
- Recovery Firmware Version
- ME Firmware Features
- ME Firmware Status #1
- ME Firmware Status #2
  - Current State
  - Error Code

### **Altitude**

This item indicates the altitude of this machine that is above the sea level. The value is shown in meters. If the value is unknown, enter the number "**8000000**".

### **MCTP (Management Component Transport Protocol) Bus Owner**

This item indicates the location of the MCTP Bus owner. Enter **0**'s to all fields to disable the MCTP Bus owner.

---

## ► PCIe/PCI/PnP Configuration

### PCI Latency Timer

Use this item to configure the PCI latency timer for a device installed on a PCI bus. Select 32 to set the PCI latency timer to 32 PCI clock cycles. The options are **32**, 64, 96, 128, 160, 192, 224, and 248 (PCI Bus Clocks).

### PERR# Generation

Select Enabled to allow a PCI device to generate a PERR (PCI/PCI-E Parity Error) number for a PCI bus error event. The options are Enabled and **Disabled**.

### SERR# Generation

Select Enabled to allow a PCI device to generate an SERR (System Error) number for a PCI bus error event. The options are Enabled and **Disabled**.

### PCI PERR/SERR Support

Select Enabled to support PERR (PCI/PCI-E Parity Error)/SERR (System Error) runtime error reporting for a PCI/PCI-E slot. The options are Enabled and **Disabled**.

### Above 4G Decoding (Available if the system supports 64-bit PCI decoding)

Select Enabled to decode a PCI device that supports 64-bit in the space above 4G Address. The options are Enabled and **Disabled**.

### SR-IOV (Available if the system supports Single-Root Virtualization)

Select Enabled for Single-Root IO Virtualization support. The options are Enabled and **Disabled**.

### Maximum Payload

Select Auto for the system BIOS to automatically set the maximum payload value for a PCI-E device to enhance system performance. The options are **Auto**, 128 Bytes, 256 Bytes, 512 Bytes, 1024 Bytes, 2048 Bytes, and 4096 Bytes.

### Maximum Read Request

Select Auto for the system BIOS to automatically set the maximum size for a read request for a PCI-E device to enhance system performance. The options are **Auto**, 128 Bytes, 256 Bytes, 512 Bytes, 1024 Bytes, 2048 Bytes, and 4096 Bytes.

### ASPM Support

Use this item to set the Active State Power Management (ASPM) level for a PCI-E device. Select Auto for the system BIOS to automatically set the ASPM level based on the system configuration. Select Disabled to disable ASPM support. The options are **Disabled** and Auto.

---

**Warning:** Enabling ASPM support may cause some PCI-E devices to fail!



### **MMIOHBase**

Use this item to select the I/O base memory size according to memory-address mapping for the PCH chip. The base memory size must be between 4032G to 4078G. The options are **56T**, 48T, 24T, 2T, 512G, and 256G.

### **MMIO High Size**

Use this item to select the high I/O memory size according to memory-address mapping for the PCH chip. The options are **256G**, 128G, 512G, and 1024G.

### **PCI Devices Option ROM Setting**

**CPU1 Slot1 PCI-E x8 OPROM/CPU1 Slot2 PCI-E x16 OPROM/CPU1 Slot3 PCI-E x8 OPROM/CPU2 Slot4 PCI-E x16 OPROM/CPU2 Slot5 PCI-E x8 OPROM/CPU2 Slot6 PCI-E x16 OPROM/CPU2 Slot7 PCI-E x16 OPROM/ Onboard Video Option ROM**

Select Enabled to enable Option ROM support to boot the computer using a device installed on the slot specified by the user. The options are Disabled, **Legacy**, and EFI.

### **Onboard LAN Option ROM Type**

Select Enabled to enable Option ROM support to boot the computer using a device installed on the slot specified by the user. The options are **Legacy** and EFI.

### **VGA Priority**

Use this item to select the graphics device to be used as the primary video display for system boot. The options are **Onboard** and Offboard.

### **Onboard LAN1 Option ROM/Onboard LAN2 Option ROM**

Use this option to select the type of device installed in LAN Port1 or LAN Port2 for system boot. The default setting for LAN1 Option ROM is **PXE**, and for LAN2 Option ROM is **Disabled**.

### **Network Stack**

Select Enabled to enable PXE (Preboot Execution Environment) or UEFI (Unified Extensible Firmware Interface) for network stack support. The options are Enabled and **Disabled**.

## ► Super IO Configuration

### Super IO Chip AST2400

#### ► Serial Port 1 Configuration/Serial Port 2 Configuration

##### Serial Port 1/Serial Port 2

Select Enabled to enable the onboard serial port specified by the user. The options are **Enabled** and Disabled.

##### Device Settings

This item displays the base I/O port address and the Interrupt Request address for a serial port specified by the user. The default setting for Serial Port 1 is IO=3F8h IRQ=4; for Serial Port 2 is IO=2F8h, IRQ=3.

##### Change Port 1 Settings/Change Port 2 Settings

This feature specifies the base I/O port address and the Interrupt Request address of Serial Port 1 or Serial Port 2. Select **Auto** for the BIOS to automatically assign the base I/O and IRQ address to a serial port specified.

The options for Serial Port 1 are **Auto**, (IO=3F8h; IRQ=4), (IO=3F8h; IRQ=3, 4, 5, 6, 7, 10, 11, 12), (IO=2F8h; IRQ=3, 4, 5, 6, 7, 10, 11, 12); (IO=3E8h; IRQ=3, 4, 5, 6, 7, 10, 11, 12), and (IO=2E8h; IRQ=3, 4, 5, 6, 7, 10, 11, 12).

The options for Serial Port 2 are **Auto**, (IO=2F8h; IRQ=3), (IO=3F8h; IRQ=3, 4, 5, 6, 7, 10, 11, 12), (IO=2F8h; IRQ=3, 4, 5, 6, 7, 10, 11, 12); (IO=3E8h; IRQ=3, 4, 5, 6, 7, 10, 11, 12), and (IO=2E8h; IRQ=3, 4, 5, 6, 7, 10, 11, 12).

##### Device Mode

Use this item to select the SUART Clock source for a serial port specified by the user. The options are **24MHz/13** and 24MHz.

##### Serial Port 2 Attribute

Select SOL to use COM Port 2 as a Serial\_Over\_LAN (SOL) port for console redirection. The options are COM and **SOL**.

## ► Serial Port Console Redirection

### COM 1

#### COM 1 Console Redirection

Select Enabled to enable COM Port 1 Console Redirection, which will allow a client machine to be connected to a host machine at a remote site for networking. The options are **Disabled** and Enabled.

*\*If the item above set to Enabled, the following items will become available for configuration:*

## ► COM1 Console Redirection Settings

### Terminal Type

Use this item to select the target terminal emulation type for Console Redirection. Select VT100 to use the ASCII Character set. Select VT100+ to add color and function key support. Select ANSI to use the Extended ASCII Character set. Select VT-UTF8 to use UTF8 encoding to map Unicode characters into one or more bytes. The options are ANSI, VT100, **VT100+**, and VT-UTF8.

### Bits Per second

Use this item to set the transmission speed for a serial port used in Console Redirection. Make sure that the same speed is used in the host computer and the client computer. A lower transmission speed may be required for long and busy lines. The options are 9600, 19200, 38400, 57600 and **115200** (bits per second).

### Data Bits

Use this item to set the data transmission size for Console Redirection. The options are 7 (Bits) and **8 (Bits)**.

### Parity

A parity bit can be sent along with regular data bits to detect data transmission errors. Select Even if the parity bit is set to 0, and the number of 1's in data bits is even. Select Odd if the parity bit is set to 0, and the number of 1's in data bits is odd. Select None if you do not want to send a parity bit with your data bits in transmission. Select Mark to add a mark as a parity bit to be sent along with the data bits. Select Space to add a Space as a parity bit to be sent with your data bits. The options are **None**, Even, Odd, Mark and Space.

### Stop Bits

A stop bit indicates the end of a serial data packet. Select 1 Stop Bit for standard serial data communication. Select 2 Stop Bits if slower devices are used. The options are **1** and **2**.

### Flow Control

Use this item to set the flow control for Console Redirection to prevent data loss caused by buffer overflow. Send a "Stop" signal to stop sending data when the receiving buffer is full. Send a "Start" signal to start sending data when the receiving buffer is empty. The options are **None** and Hardware RTS/CTS.

**VT-UTF8 Combo Key Support**

Select Enabled to enable VT-UTF8 Combination Key support for ANSI/VT100 terminals. The options are **Enabled** and Disabled.

**Recorder Mode**

Select Enabled to capture the data displayed on a terminal and send it as text messages to a remote server. The options are **Disabled** and Enabled.

**Resolution 100x31**

Select Enabled for extended-terminal resolution support. The options are Disabled and **Enabled**.

**Legacy OS Redirection Resolution**

Use this item to select the number of rows and columns used in Console Redirection for legacy OS support. The options are 80x24 and **80x25**.

**Putty KeyPad**

Use this item to select Function Keys and KeyPad settings for Putty, which is a terminal emulator designed for the Windows OS. The options are **VT100**, LINUX, XTERMR6, SCO, ESCN, and VT400.

**Redirection After BIOS Post**

Use this item to enable or disable legacy Console Redirection after BIOS POST (Power-On Self-Test). When "Bootloader" is selected, legacy Console Redirection is disabled before booting the OS. When "Always Enable" is selected, legacy Console Redirection remains enabled while the OS boots up. The options are **Always Enable** and Bootloader.

**SOL/COM2****SOL/COM2 Console Redirection**

Select Enabled to use the SOL port for Console Redirection. The options are **Enabled** and Disabled.

*\*If the item above set to Enabled, the following items will become available for user's configuration:*

## ► SOL/COM2 Console Redirection Settings

Use this feature to specify how the host computer will exchange data with the client computer, which is the remote computer used by the user.

### Terminal Type

Use this feature to select the target terminal emulation type for Console Redirection. Select VT100 to use the ASCII Character set. Select VT100+ to add color and function key support. Select ANSI to use the Extended ASCII Character Set. Select VT-UTF8 to use UTF8 encoding to map Unicode characters into one or more bytes. The options are ANSI, VT100, **VT100+**, and VT-UTF8.

### Bits Per second

Use this feature to set the transmission speed for a serial port used in Console Redirection. Make sure that the same speed is used in the host computer and the client computer. A lower transmission speed may be required for long and busy lines. The options are 9600, 19200, 38400, 57600 and **115200** (bits per second).

### Data Bits

Use this feature to set the data transmission size for Console Redirection. The options are 7 (Bits) and **8 (Bits)**.

### Parity

A parity bit can be sent along with regular data bits to detect data transmission errors. Select Even if the parity bit is set to 0, and the number of 1's in data bits is even. Select Odd if the parity bit is set to 0, and the number of 1's in data bits is odd. Select None if you do not want to send a parity bit with your data bits in transmission. Select Mark to add a mark as a parity bit to be sent along with the data bits. Select Space to add a Space as a parity bit to be sent with your data bits. The options are **None**, Even, Odd, Mark and Space.

### Stop Bits

A stop bit indicates the end of a serial data packet. Select 1 Stop Bit for standard serial data communication. Select 2 Stop Bits if slower devices are used. The options are **1** and 2.

### Flow Control

Use this feature to set the flow control for Console Redirection to prevent data loss caused by buffer overflow. Send a "Stop" signal to stop sending data when the receiving buffer is full. Send a "Start" signal to start data-sending when the receiving buffer is empty. The options are **None** and Hardware RTS/CTS.

**VT-UTF8 Combo Key Support**

Select Enabled to enable VT-UTF8 Combination Key support for ANSI/VT100 terminals. The options are **Enabled** and Disabled.

**Recorder Mode**

Select Enabled to capture the data displayed on a terminal and send it as text messages to a remote server. The options are **Disabled** and Enabled.

**Resolution 100x31**

Select Enabled for extended-terminal resolution support. The options are Disabled and **Enabled**.

**Legacy OS Redirection Resolution**

Use this feature to select the number of rows and columns used in Console Redirection for legacy OS support. The options are 80x24 and **80x25**.

**Putty KeyPad**

This feature selects Function Keys and KeyPad settings for Putty, which is a terminal emulator designed for the Windows OS. The options are **VT100**, LINUX, XTERMR6, SCO, ESCN, and VT400.

**Redirection After BIOS Post**

Use this feature to enable or disable legacy Console Redirection after BIOS POST (Power-On Self-Test). When this feature is set to Bootloader, legacy Console Redirection is disabled before booting the OS. When this feature is set to Always Enable, legacy Console Redirection remains enabled upon OS boot. The options are **Always Enable** and Bootloader.

**Legacy Console Redirection**

The submenu allows the user to configure Legacy Console Redirection settings so that legacy devices can be used for Console Redirection.

**► Legacy Console Redirection Settings**

Use this feature to specify how the host computer will communicate with the client compute at a remote site via legacy devices.

**Legacy Serial Redirection Port**

The feature selects a legacy serial port to be used for Console Redirection. The options are **COM1 Console Redirection** and COM2/SOL Console Redirection.

## **Serial Port for Out-of-Band Management/Windows Emergency Management Services (EMS)**

The submenu allows the user to configure Console Redirection settings to support Out-of-Band Serial Port management.

### **(EMS) Console Redirection**

Select Enabled to use a COM port selected by the user for EMS Console Redirection. The options are Enabled and **Disabled**.

\*If the item above set to Enabled, the following items will become available for user's configuration:

### **►EMS Console Redirection Settings (Available when EMS Console Redirection is enabled)**

Use this feature to specify how the host computer will exchange data with the client computer, which is the remote computer used by the user.

#### **Out-of-Band Management Port**

The feature selects a serial port in a client server to be used by the Windows Emergency Management Services (EMS) to communicate with a remote host server. The options are **COM1 (Console Redirection)** and COM2/SOL (Console Redirection).

#### **Terminal Type**

Use this feature to select the target terminal emulation type for Console Redirection. Select VT100 to use the ASCII character set. Select VT100+ to add color and function key support. Select ANSI to use the extended ASCII character set. Select VT-UTF8 to use UTF8 encoding to map Unicode characters into one or more bytes. The options are ANSI, VT100, VT100+, and **VT-UTF8**.

#### **Bits Per Second**

This item sets the transmission speed for a serial port used in Console Redirection. Make sure that the same speed is used in both host computer and the client computer. A lower transmission speed may be required for long and busy lines. The options are 9600, 19200, 57600, and **115200** (bits per second).

#### **Flow Control**

Use this item to set the flow control for Console Redirection to prevent data loss caused by buffer overflow. Send a "Stop" signal to stop data-sending when the receiving buffer is full. Send a "Start" signal to start data-sending when the receiving buffer is empty. The options are **None**, Hardware RTS/CTS, and Software Xon/Xoff.

The following settings will be displayed:

### Data Bits, Parity, Stop Bits

## ► Enabling TPM in the BIOS

The steps below describe the proper procedure on how to enable the TPM in the BIOS. This process is necessary to activate support in the system before you can start using the TPM.

1. Enter the BIOS setup screen. You may do this either from the IPMI remote console or from the server directly using KVM. Reboot the system and press the <Del> key as the system boots until you reach the BIOS screen.
2. You will be presented with the BIOS setup main screen. Using the arrow keys, navigate to the Advanced tab. From there, navigate down and select the "CPU Configuration" option as shown below. Press <Enter>.
3. You will be taken to the CPU Configuration page. Using the arrow keys, navigate down to the "Intel Virtualization Technology" option and press <Enter>. Select "Enable" and press <Enter>.

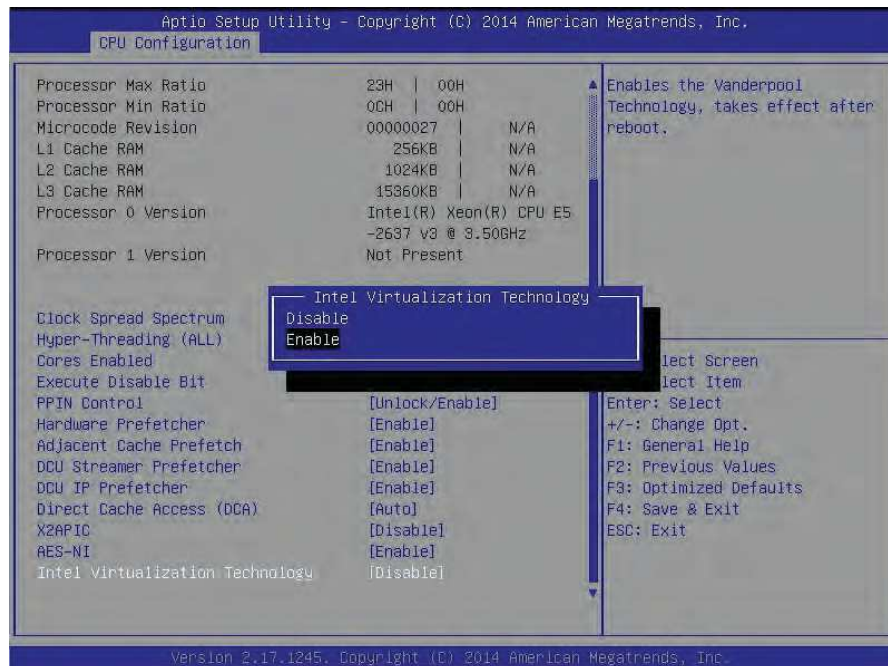



- From the window that pops up, select "Enabled" and press <Enter>.

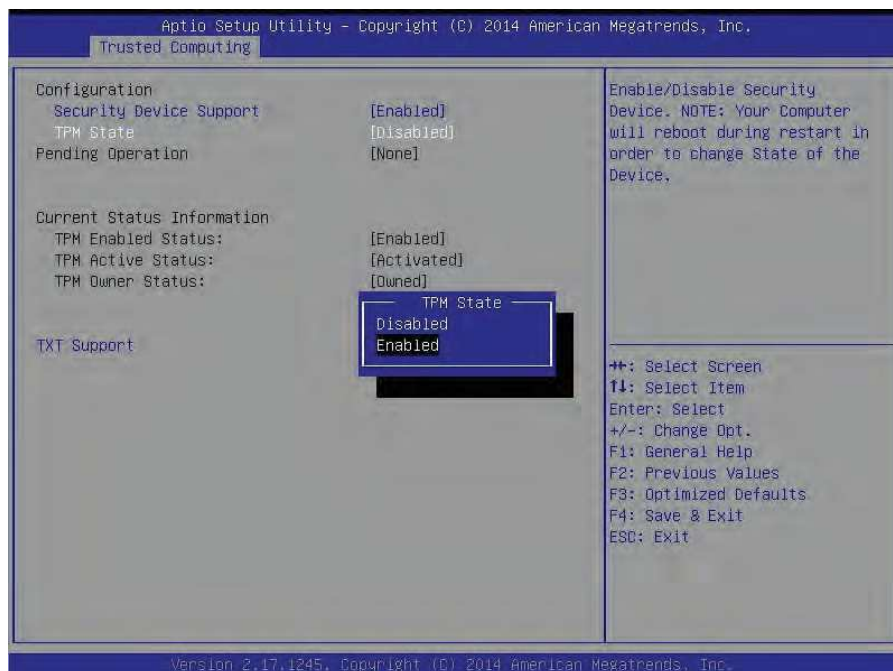

- You must save your changes and reset for the changes to take effect. Scroll to the Save & Exit tab and select "Save Changes and Reset." The TPM is now enabled.

## ► Intel TXT (LT-SX) Configuration

This submenu allows the user to configure the following TXT settings.

### TXT Support

Select Enabled to enable Intel Trusted Execution Technology (TXT) support. The options are **Disabled** and Enabled.

 **Note:** If the option for this item (TXT Support) is set to Enabled, be sure to disable EV DFX (Device Function On-Hide) support for the system to work properly. (EV DFX is under "I/O Configuration" in the "Chipset/North Bridge" submenu on Page 4-11).

 **Note:** For more information on TPM, please refer to the TPM manual at [http://www.supermicro.com/manuals/other/AOM-TPM-9655V\\_9655H.pdf](http://www.supermicro.com/manuals/other/AOM-TPM-9655V_9655H.pdf)

## ►ACPI Settings

### WHEA Support

Select Enabled to support the Windows Hardware Error Architecture (WHEA) platform and provide a common infrastructure for the system to handle hardware errors within the Windows OS environment to reduce system crashes and to enhance system recovery and health monitoring. The options are **Enabled** and Disabled.

### High Precision Event Timer

Select Enabled to activate the High Precision Event Timer (HPET) that produces periodic interrupts at a much higher frequency than a Real-time Clock (RTC) does in synchronizing multimedia streams, providing smooth playback and reducing the dependency on other timestamp calculation devices, such as an x86 RDTSC Instruction embedded in the CPU. The High Performance Event Timer is used to replace the 8254 Programmable Interval Timer. The options are **Enabled** and Disabled.

### NUMA (Available when the OS supports this feature)

Select Enabled to enable Non-Uniform Memory Access support to enhance system performance. The options are **Enabled** and Disabled.

## ►iSCSI Configuration

This item displays iSCSI configuration information:

### iSCSI Initiator Name

Use this item to enter the name of the iSCSI Initiator, which is a unique name used in the world. The name must be in the IQN format. The following submenu will be available for configuration:

#### ►Add an Attempt

#### ►Delete Attempts

#### ►Change Attempt Order

## 4-4 Event Logs

This submenu allows the user to configure Event Log settings.

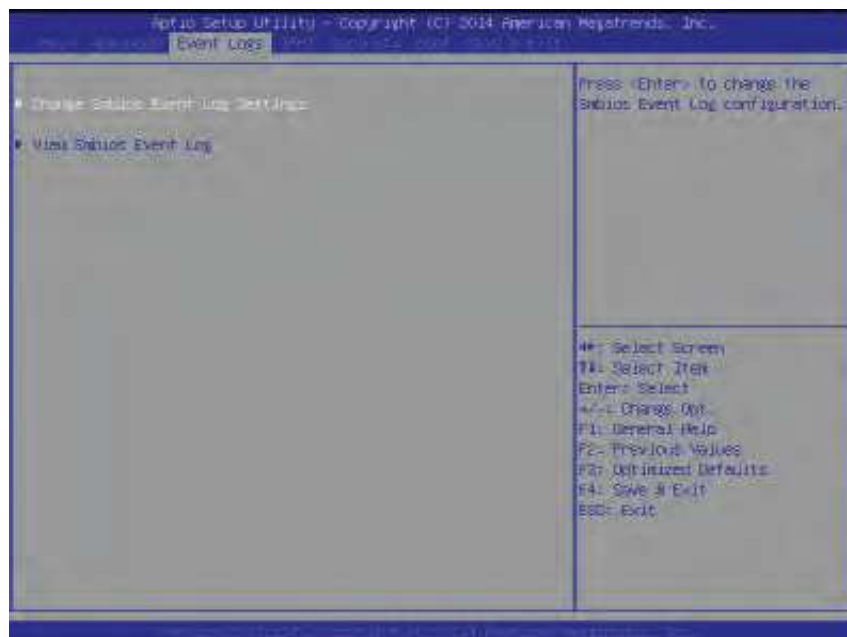

### ► Change SMBIOS Event Log Settings

This feature allows the user to configure SMBIOS Event settings.

#### Enabling/Disabling Options

##### SMBIOS Event Log

Select Enabled to enable SMBIOS (System Management BIOS) Event Logging during system boot. The options are **Enabled** and Disabled.

##### Runtime Error Logging Support

Select Enable to support Runtime Error logging. The options are **Enabled** and Disabled. If this item is set to Enabled, the following item will be available for configuration:

## Erasing Settings

### Erase Event Log

Select Yes to erase all error events in the SMBIOS (System Management BIOS) log before an event logging is initialized at bootup. The options are **No**, Yes, Next reset, and Yes, every reset.

### When Log is Full

Select Erase Immediately to immediately erase all errors in the SMBIOS event log when the event log is full. Select Do Nothing for the system to do nothing when the SMBIOS event log is full. The options are **Do Nothing** and Erase Immediately.

## SMBIOS Event Log Standard Settings

### Log System Boot Event

Select Enabled to log system boot events. The options are **Disabled** and Enabled.

### MECI (Multiple Event Count Increment)

Enter the increment value for the multiple event counter. Enter a number between 1 to 255. The default setting is **1**.

### METW (Multiple Event Count Time Window)

This item is used to determine how long (in minutes) the multiple event counter should wait before generating a new event log. Enter a number between 0 to 99. The default setting is **60**.

 **Note:** Please reboot the system for the changes to take effect.

## ►View SMBIOS Event Log

This item allows the user to view the event in the SMBIOS event log. The following categories are displayed:

**Date/Time/Error Code/Severity**

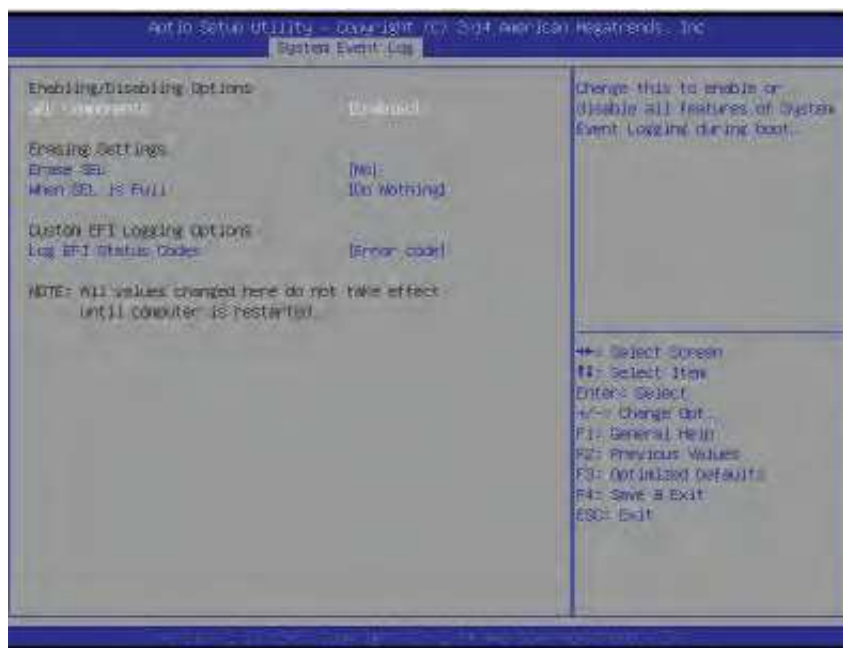

### BMC (Baseboard Management Controller) Firmware Revision

This item indicates the BMC firmware revision used in your system.

### Status of BMC

This item indicates the status of the onboard BMC chip installed in your system.

## ► System Event Log

### Enabling/Disabling Options

#### SEL Components

Select Enabled to enable all system event logging support at bootup. The options are **Enabled** and Disabled.

#### Erasing Settings

#### Erase SEL

Select Yes, On next reset to erase all system event logs upon next system reboot. Select Yes, On every reset to erase all system event logs upon each system reboot. Select No to keep all system event logs after each system reboot. The options are **No**, Yes, On next reset, and Yes, On every reset.

### When SEL is Full

This feature allows the user to determine what the AMI BIOS should do when the system event log is full. Select Erase Immediately to erase all events in the log when the system event log is full. The options are **Do Nothing** and Erase Immediately.

 **Note:** After making changes on a setting, be sure to reboot the system for the changes to take effect.

### ►BMC Network Configuration

The following items will be displayed:

- IPMI LAN Selection
- IPMI Network Link Status

### Update IPMI LAN Configuration

Select Yes for the system BIOS to automatically reset the following IPMI settings upon next system boot. The options are Yes and **No**.

### Configuration Address Source (Available when the item above - Update IPMI LAN Configuration is set to Yes)

Use this item to select the IP address source for this computer. If Static is selected, you will need to know the IP address of this computer and enter it to the system manually in the field. If DHCP is selected, AMI BIOS will search for a DHCP (Dynamic Host Configuration Protocol) server attached to the network and request the next available IP address for this computer. The options are **DHCP** and Static.

### Station IP Address

This item displays the Station IP address for this computer. This should be in decimal and in dotted quad form (i.e., 192.168.10.253).

### Subnet Mask

This item displays the sub-network that this computer belongs to. The value of each three-digit number is separated by dots and it should not exceed 255.

### Station MAC Address

This item displays the Station MAC address for this computer. Mac addresses are 6 two-digit hexadecimal numbers.

### Gateway IP Address

This item displays the Gateway IP address for this computer. This should be in decimal and in dotted quad form (i.e., 192.168.10.253).

## 4-6 Security Settings

This submenu allows the user to configure the following security settings for the system.

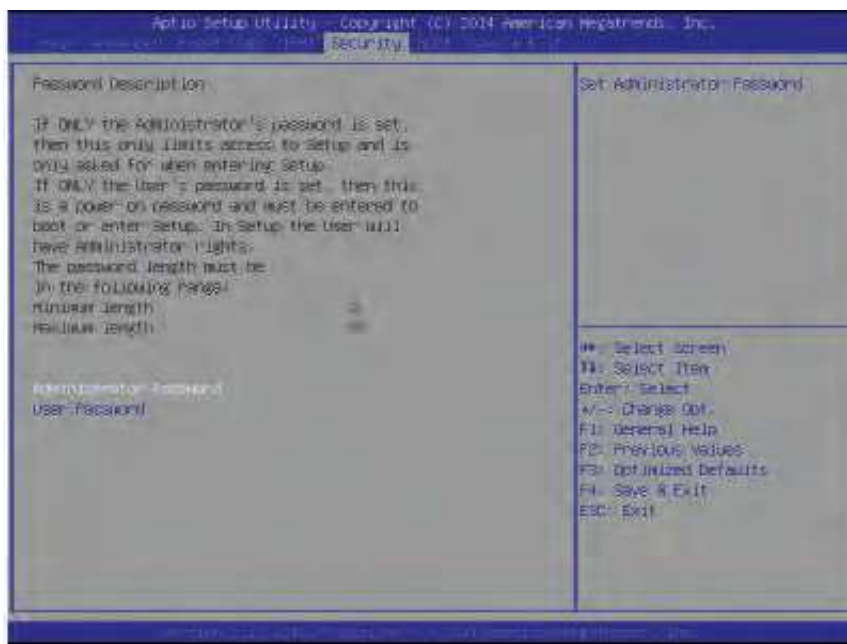

### Administrator Password

Use this feature to set the administrator password which is required before entering the BIOS setup utility. The length of the password should be from 3 characters to 20 characters long.

### User Password (Available after an Administrator Password is entered)

Use this feature to set the user password which is required to enter the BIOS setup utility. The length of the password should be from 3 characters to 20 characters long.

## 4-7 Boot Settings

This submenu allows the user to configure Boot settings for this system:







**Discard Changes and Exit**

Select this item to exit from the BIOS setup without making any permanent changes to the system configuration, and reboot the computer.

**Save Changes and Reset**

When you have completed the system configuration changes, select this item to leave the BIOS setup utility and reboot the computer for the new system configuration parameters to take effect. Select Yes and press <Enter> to save the changes you've made and reboot the system.

**Save Options****Save Changes**

When you have completed the system configuration changes, select this item to save all changes made. This will not reset (reboot) the system.

**Discard Changes**

Select this item to discard all the changes and return to the AMI BIOS setup utility. Select Yes and press <Enter> to discard all changes made.

**Restore Defaults**

Select this item and press <Enter> to load the manufacture default settings which are designed for maximum system performance but not for maximum stability.

**Save As User Defaults**

Select this item and press <Enter> to save the current BIOS settings as user's default settings for future use.

**Restore User Defaults**

Select this item and press <Enter> to retrieve the user-defined default settings that were previously saved to be used as current default settings.

**Boot Override**

This feature allows the user to override the boot priority sequence in the Boot sub-menu and immediately boot the system with another device specified by the user. This is a one-time override.

## Appendix A

### BIOS POST Error Beep Codes

During the POST (Power-On Self-Test) routines, which are performed upon each system boot, errors may occur.

**Non-fatal errors** are those which, in most cases, allow the system to continue to boot. These error messages normally appear on the screen.

**Fatal errors** will not allow the system to continue with bootup. If a fatal error occurs, you should consult with your system manufacturer for possible repairs.

These fatal errors are usually communicated through a series of audible beeps. The numbers on the fatal error list correspond to the number of beeps for the corresponding error.

#### A-1 BIOS POST Error Beep Codes

|  |  |  |
|--|--|--|
|  |  |  |
|  |  |  |
|  |  |  |
|  |  |  |
|  |  |  |
|  |  |  |
|  |  |  |
|  |  |  |
|  |  |  |
|  |  |  |

## Appendix B

### Software Installation Instructions

#### B-1 Installing Software Programs

The Supermicro website that contains drivers and utilities for your system is located at <http://www.supermicro.com/wftp>. Some of these must be installed, such as the chipset driver.

After accessing the product drivers and utilities page, go into the CDR\_Images directory and locate the ISO file for your motherboard. Download this file to create a DVD of the drivers and utilities it contains. (You may also use a utility to extract the ISO file if preferred.)

After creating a DVD with the ISO files, insert the disk into the DVD drive on your system and the display shown in Figure B-1 should appear.

Another option is to go to the Supermicro website at <http://www.supermicro.com/products/>. Find the product page for your motherboard here, where you may download individual drivers and utilities to your hard drive or a USB flash drive and install from there.

 **Note:** Please refer to the documents posted on our website at <http://www.supermicro.com/support/manuals/> for additional instructions that may be applicable to your system.



**B-1. Driver/Tool Installation Display Screen**

Click the icons showing a hand writing on the paper to view the readme files for each item. Click a computer icon to the right of an item to install an item (from top to the bottom) one at a time. After installing each item, you must reboot the system before proceeding with the next item on the list. The bottom icon with a CD on it allows you to view the entire contents of the CD.

When making a storage driver diskette by booting into a driver CD, please set the SATA Configuration to "Compatible Mode" and configure SATA as IDE in the BIOS Setup. After making the driver diskette, be sure to change the SATA settings back to your original settings.

## B-2 SuperDoctor® 5

The Supermicro SuperDoctor 5 is a hardware monitoring program that functions in a command-line or web-based interface in Windows and Linux operating systems. The program monitors system health information such as CPU temperature, system voltages, system power consumption, fan speed, and provides alerts via email or Simple Network Management Protocol (SNMP).

SuperDoctor 5 comes in local and remote management versions and can be used with Nagios to maximize your system monitoring needs. With SuperDoctor 5 Management Server (SSM Server), you can remotely control power on/off and reset chassis intrusion for multiple systems with SuperDoctor 5 or IPMI. SD5 Management Server monitors HTTP and SMTP services to optimize the efficiency of your operation.

 **Note:** The default Username and Password for SuperDoctor 5 is ADMIN / ADMIN.

### B-2. SuperDoctor 5 Interface Display Screen (Health Information)



 **Note:** The SuperDoctor 5 program and user's manual can be downloaded from the Supermicro website at [http://www.supermicro.com/products/nfo/sms\\_sd5.cfm](http://www.supermicro.com/products/nfo/sms_sd5.cfm).

## **B-3 Logging into the BMC (Baseboard Management Controller)**

Supermicro ships standard products with a unique password for the BMC ADMIN user. This password can be found on a label on the motherboard.

When logging in to the BMC for the first time, please use the unique password provided by Supermicro to log in. You can change the unique password to a user name and password of your choice for subsequent logins.

For more information regarding BMC passwords, please visit our website at <http://www.supermicro.com/bmcpassword>.

## Appendix C

### UEFI BIOS Recovery Instructions

**Warning:** Do not upgrade the BIOS unless your system has a BIOS-related issue. Flashing the wrong BIOS can cause irreparable damage to the system. In no event shall Supermicro be liable for direct, indirect, special, incidental, or consequential damages arising from a BIOS update. If you need to update the BIOS, do not shut down or reset the system while the BIOS is updating to avoid possible boot failure.

#### C-1 An Overview to the UEFI BIOS

The Unified Extensible Firmware Interface (UEFI) provides a software-based interface between the operating system and the platform firmware in the pre-boot environment. The UEFI specification supports an architecture-independent mechanism for add-on card initialization to allow the UEFI OS loader, which is stored in the add-on card, to boot the system. The UEFI offers a clean, hands-off control to a computer system at bootup.

#### C-2 How to Recover the UEFI BIOS Image (-the Main BIOS Block)

A UEFI BIOS flash chip consists of a recovery BIOS block and a main BIOS block (a main BIOS image). The boot block contains critical BIOS codes, including memory detection and recovery codes for the user to flash a new BIOS image if the original main BIOS image is corrupted. When the system power is on, the boot block codes execute first. Once it is completed, the main BIOS code will continue with system initialization and bootup.



**Note:** Follow the BIOS recovery instructions below for BIOS recovery when the main BIOS boot crashes. However, when the BIOS boot block crashes, you will need to follow the procedures below for BIOS recovery.

#### C-3 To Recover the Main BIOS Block Using a USB-Attached Device

This feature allows the user to recover a BIOS image using a USB-attached device without additional utilities used. A USB flash device such as a USB Flash Drive, or a USB CD/DVD ROM/RW device can be used for this purpose. However, a USB Hard Disk drive cannot be used for BIOS recovery at this time.

The file system supported by UEFI is FAT (including FAT12, FAT16, and FAT32) installed on a bootable or non-bootable USB-attached device. However, the BIOS might need several minutes to locate the SUPER.ROM file if the media size becomes too large because it contains too many folders and files.

To perform UEFI BIOS recovery using a USB-attached device, follow the instructions below.

1. Using a different machine, copy the "Super.ROM" binary image file into the disc Root "\\" Directory of a USB device or a writeable CD/DVD.

 **Note:** If you cannot locate the "Super.ROM" file in your driver disk, visit our website at [www.supermicro.com](http://www.supermicro.com) to download the BIOS image into a USB flash device and rename it "Super.ROM" for BIOS recovery use.

2. Insert the USB device that contains the new BIOS image ("Super.ROM") into your USB drive and power on the system
3. While powering on the system, please keep pressing <Ctrl> and <Home> simultaneously on your keyboard until the following screen (or a screen similar to the one below) displays.

**Warning!!** Please **stop** pressing the <Ctrl> and <Home> keys immediately when you see the screen (or a similar screen) below; otherwise, it will trigger a system reboot.



 **Note:** On the other hand, if the following screen displays, please load the "Super.ROM" file to the root folder and connect this folder to the system. (You can do so by inserting a USB device that contains the new "Super.ROM" image to your machine for BIOS recovery.)





- After locating the new BIOS binary image, the system will enter the BIOS Recovery menu as shown below.

 **Note:** At this point, you may decide if you want to start with BIOS recovery. If you decide to proceed with BIOS recovery, follow the procedures below.

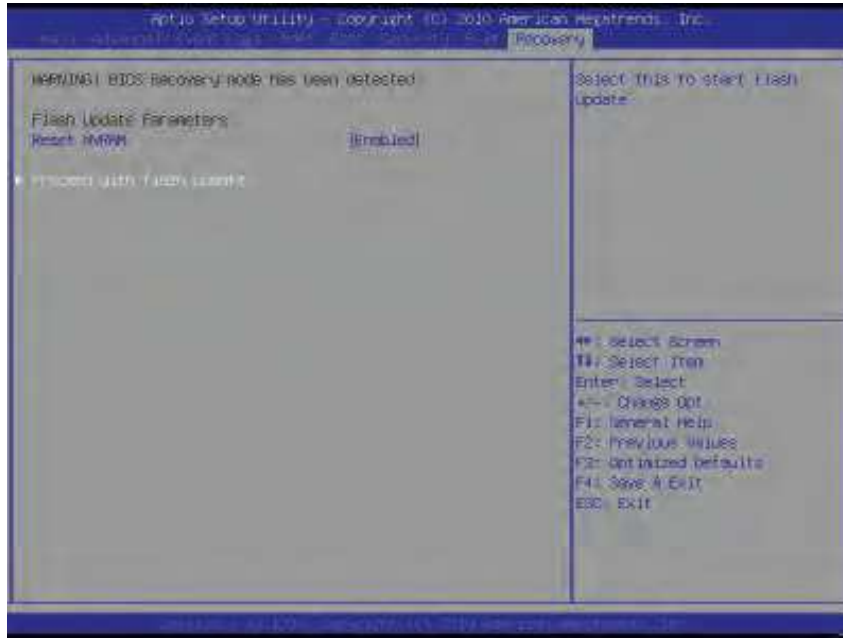

- When the screen as shown above displays, using the arrow key, select the item "Proceed with flash update" and press the <Enter> key. You will see the progress of BIOS recovery as shown in the screen below.

 **Note:** *Do not interrupt* the process of BIOS flashing until it is completed.

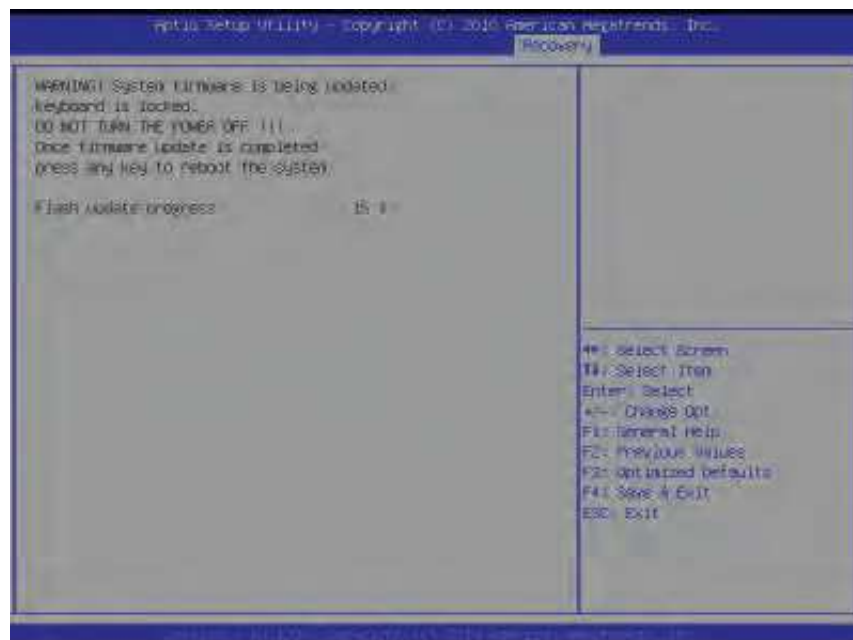

6. After the process of BIOS recovery is completed, press any key to reboot the system.

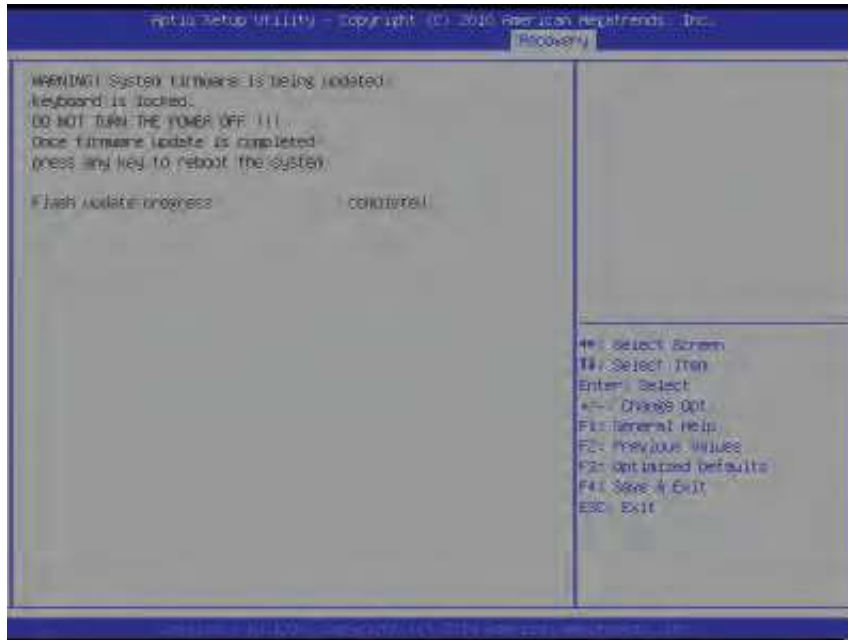

7. Using a different system, extract the BIOS package into a bootable USB flash drive.
8. When a DOS prompt appears, enter FLASH.BAT BIOSname.### at the prompt.



**Note:** Do not interrupt this process until BIOS flashing is completed.

9. After seeing the message that BIOS update is completed, unplug the AC power cable from the power supply to clear the CMOS, and then plug the AC power cable in the power supply again to power on the system.
10. Press <Del> continuously to enter the BIOS Setup utility.
11. Press <F3> to load default settings.
12. After loading default settings, press <F4> to save the settings and exit the BIOS Setup utility.