

RoHS 2 Compliant

User's Guide

iSeries

Shop on line at

omega.com[®]

Ω OMEGA[®]

www.omega.com

e-mail: info@omega.com

For iSeries info:

www.omega.com/specs/iseries

For latest product manuals:

www.omegamanual.info



Monitor / Controller

Communication Manual



OMEGAnet® On-Line Service www.omega.com	Internet e-mail info@omega.com
--	---

Servicing North America:

USA:
ISO 9001 Certified
One Omega Drive, P.O. Box 4047
Stamford CT 06907-0047
TEL: (203) 359-1660 FAX: (203) 359-7700
e-mail: info@omega.com

Canada:
976 Bergar
Laval (Quebec) H7L 5A1
TEL: (514) 856-6928 FAX: (514) 856-6886
e-mail: info@omega.ca

For immediate technical or application assistance:

USA and Canada: Sales Service: 1-800-826-6342 / 1-800-TC-OMEGA®
Customer Service: 1-800-622-2378 / 1-800-622-BEST®
Engineering Service: 1-800-872-9436 / 1-800-USA-WHEN®

Mexico and Latin America: TEL: (001) 203-359-7803 FAX: (001) 203-359-7807
e-mail: espanol@omega.com

Servicing Europe:

Benelux: TEL: +31 20 3472121 FAX: +31 20 6434643
Toll Free in Benelux: 0800 0993344
e-mail: sales@omegaeng.nl

Czech Republic: Frystatska 184, 733 01 Karviná
TEL: +420 59 6311899 FAX: +420 59 6311114
e-mail: info@omegashop.cz

France: TEL: +33 1 61 37 29 00 FAX: +33 1 30 57 54 27
Toll Free in France: 0800 466 342
e-mail: sales@omega.fr

Germany/Austria: Daimlerstrasse 26, D-75392 Deckenpfronn, Germany
TEL: +49 7056 9398-0 FAX: +49 7056 9398-29
Toll Free in Germany: 0800 639 7678
e-mail: info@omega.de

United Kingdom:
ISO 9001 Certified
One Omega Drive
River Bend Technology Centre
Northbank, Irlam Manchester M44 5BD United Kingdom
TEL: +44 161 777 6611 FAX: +44 161 777 6622
Toll Free in England: 0800 488 488
e-mail: sales@omega.co.uk

It is the policy of OMEGA to comply with all worldwide safety and EMC/EMI regulations that apply. OMEGA is constantly pursuing certification of its products to the European New Approach Directives. OMEGA will add the mark to every appropriate device upon certification.

The information contained in this document is believed to be correct, but OMEGA Engineering, Inc. accepts no liability for any errors it contains, and reserves the right to alter specifications without notice.

WARNING: These products are not designed for use in, and should not be used for, patient-connected applications.



This device is marked with the international caution symbol. It is important to read the Setup Guide before installing or commissioning this device as the guide contains important information relating to safety and EMC.

TABLE OF CONTENTS

Part 1: Before You Begin	2
Part 2: Introduction to Digital Communication	3
2.1 Overview	3
2.2 Definition of Terms	3
Part 3: Hardware	5
3.1 Communication Interfaces	5
3.2 Wiring RS-232 Interface	5
3.3 Wiring RS-485 Interface	6
Part 4: Communication Setup	9
4.1 Flow Chart	9
4.2 Setup the iSeries Device Through the Front Panel	10
4.3 Abbreviations, Range, Default Setup	10
Part 5: iSeries Protocol	13
5.1 Command Structure	13
5.2 Command Formats	14
5.3 Response Format	19
5.4 Error Message	20
5.5 Alarm Status Characters	20
5.6 Examples of Transmitted Data	21
5.7 Command Formats	22
5.7.1 Input Type (Command Index 07)	22
5.7.1.1 Input Type for Temperature/Process	22
5.7.1.2 Input Type for Process/Strain Gauge	23
5.7.2 Reading Configuration (Command Index 08)	23
5.7.2.1 Reading Configuration for Temperature/Process	23
5.7.2.2 Reading Configuration for Process/Strain Gauge	24
5.7.3 Linearization Points (Command Index 29)	24
5.7.4 Color Display (Command Index 11)	25
5.7.5 Alarm 1 Configuration (Command Index 09)	25
5.7.6 Alarm 1 Low (Command Index 12)	26
5.7.7 Alarm 2 Configuration (Command Index 0A)	26
5.7.8 Output 1 Configuration (Command Index 0C)	27
5.7.9 Output 2 Configuration (Command Index 0D)	27
5.7.10 Communication Parameters (Command Index 10)	28
5.7.11 Bus Format (Command Index 1F)	28
5.7.12 Data Format (Command Index 20)	29
5.7.13 Miscellaneous (Command Index 24)	29
5.7.14 % Low and % Hi (Command Index 27 and 28)	30
5.7.15 Reading Scale and Offset (Command Index 14 and 3A)	30
5.7.16 Grouping Commands with the Same Formats	33

Part 6: Modbus Protocol.....	34
6.1 Introduction.....	34
6.2 RTU Mode.....	34
6.3 Device Address.....	35
6.4 Function Code.....	35
6.5 Data Field.....	36
6.6 CRC Checking.....	36
6.7 Modbus RTU Registers.....	37
6.8 Command Format.....	38
6.8.1 Read Multiple Register (03 or 04).....	38
6.8.2 Write to Single Register (06).....	39
6.8.3 Diagnostic Command.....	41
6.8.4 Error Response.....	41
Appendix A Reading Scale and Offset.....	43
Appendix B ASCII Chart.....	48
ASCII Control Codes.....	49
Appendix C Examples of CRC Calculation.....	50
Example of CRC Calculation in “C” Language.....	53

LIST OF FIGURES:

Figure 2.1 Transmission of “c”.....	4
Figure 3.1 DB9 and RS-232 Wiring.....	6
Figure 3.2 DB25 and RS-232 Wiring.....	6
Figure 3.3 Multipoint, Half-Duplex RS-485 Wiring.....	7
Figure 4.1 Flow Chart for Communication Option.....	9

LIST OF TABLES:

Table 3.1 Communication Interface.....	5
Table 3.2 Wiring RS-232 Interface.....	6
Table 3.3 RS-485 Half Duplex Hook-up.....	8
Table 4.1 Abbreviations, Range, Default Setup.....	10
Table 5.1 Command Prefix Letters.....	13
Table 5.2 Command Formats.....	14
Table 5.3 Command Letters and Suffix.....	14
Table 5.4 Command Letters and Suffix.....	16
Table 5.5 Echo Mode.....	19
Table 5.6 No Echo Mode.....	19
Table 5.7 Error Message.....	20
Table 5.8 Alarm Status Characters.....	20
Table 5.9 Conversion Number.....	30
Table 5.10 Commands with Numeric Data Format.....	33
Table 6.1 Function Code.....	35
Table 6.2 Modbus Registers.....	37
Table A.1 Conversion Number.....	43
Table A.2 Input Resolution Multiplier.....	43

NOTES, WARNINGS and CAUTIONS

Information that is especially important to note is identified by following labels:

- **NOTE**
- **WARNING or CAUTION**
- **IMPORTANT**
- **TIP**



NOTE: Provides you with information that is important to successfully setup and use the Programmable Digital Meter.



CAUTION or WARNING: Tells you about the risk of electrical shock.



CAUTION, WARNING or IMPORTANT: Tells you of circumstances or practices that can effect the instrument's functionality and must refer to accompanying documents.



TIP: Provides you helpful hints.

PART 1 BEFORE YOU BEGIN

Customer Service

If you need assistance, please call the nearest Customer Service Department, listed in this manual.

Manuals, Software

The latest Operation and Communication Manual as well as free configuration software and ActiveX controls are available from **the website listed in this manual or on the CD-ROM enclosed with your shipment.**



For first-time users: Refer to the QuickStart Manual for basic operation and set-up instructions.





For the Serial Communications/Ethernet Option you can easily configure the controller on your computer or on-line.

Communication Menu

The Communication menu only appears with devices purchased with the RS-232C / RS-485 Serial Communications Option. Purchasing the controller with Serial Communications permits a controller to be connected directly to the PC's available COM port. Device can be configured or monitored from an IBM PC compatible computer using software available on our CD or on our website.

To Disable Outputs



Standby Mode is useful during setup of the controller or when maintenance of the system is necessary. When the controller is in standby, it remains in the ready condition but all outputs are disabled. This allows the system to remain powered and ready to go.

1. When the controller is in "RUN" Mode, **push**  **twice** to disable all outputs and alarms. It is now in "STANDBY" Mode.
2. Push  once more to resume "RUN" Mode.



PUSH  **TWICE** to disable the system during an **EMERGENCY**.

To Reset the Meter

1. When the controller is in the "MENU" Mode, **push**  **down button once** to direct controller one step backward of the top menu item.
2. **Push**  **twice** to reset controller, prior to resuming "Run" Mode except after "Setpoints" and "Alarms" that will go to the "Run" Mode without resetting the controller.

PART 2

INTRODUCTION TO DIGITAL COMMUNICATION

2.1 Overview

This manual describes how to use a digital communication link and iSeries or MODBUS communication protocols to operate the iSeries controllers. It has been assumed that the user has some experience of communication protocols and some familiarity with iSeries controllers.

2.2 Definitions of terms

This guide is intended to help the user to become familiar with digital communication between a computer (or other controlling instrument) and one or more devices.

User of this manual should be familiar with following definitions:

- **Serial Communication** is the exchange of the data one bit at a time on a single data line. Serial compares with parallel communication, which sends several bits of information simultaneously over multiple lines or channels.
- **Interface** are connections over which computers communicate. They may use one pair of wires to send information in one direction and another pair to send in the opposite direction (**full duplex**). They may also use one pair to send the information in both directions (**half duplex**).
- **Bit** is a unit of digital data (binary digit) either a “1” or “0”.
- **Byte** is a string of seven or eight bits, which represents a single character.
- **ASCII** (American Standard Code for Information Interchange) – is a 7-bit code defines 128 characters, which include digits, upper and lowercase letters, punctuation symbols, and control codes such as backspace, line feed, carriage return and so on. The ASCII code can be written in a base – 16 number system, called hexadecimal (“hex”). The first 10 digits of this system are represented by the numbers 0 through 9, and the other six digits are represented by the letters A through F. The 128 ASCII character code with the decimal, hexadecimal and binary equivalents is listed in **Appendix B**.
- **Synchronous and Asynchronous Communications**
There are two basic types of serial communications, synchronous and asynchronous. With synchronous communications, the two devices initially synchronize themselves to each other, and then continually send characters to stay in sync. Asynchronous means “no synchronization”, and thus does not require sending and receiving idle characters. However, the beginning and end of each byte of data must be identified by start and stop bits. The serial ports on IBM-style PCs are asynchronous devices and therefore only support asynchronous serial communications.

- **Start and Stop Bits**

The start and stop bits identify the beginning and end of each character and permit a receiver to resynchronize a local clock to each new character. The start bit indicates when the data byte is about to begin and the stop bit signals when it ends. The start bit is always a 0. The stop bit is always a 1.

• **Parity Bit**

Besides the synchronization provided by the use of start and stop bits, an additional bit called a parity bit may optionally be transmitted along with the data. A parity bit affords a small amount of error checking, to help detect data corruption that might occur during transmission. You can choose either **even** parity, **odd** parity or **no** parity at all. When even or odd parity is being used, the number of marks (logical 1 bits) in each data byte are counted, and a single bit is transmitted following the data bits to indicate whether the number of 1 bits just sent is even or odd.

For example, when even parity is chosen, the parity bit is transmitted with a value of 0 if the number of preceding marks (1's) is an even number. For the binary value of 0110 0011 the even parity bit would be 0. If even parity were in effect when the binary number 1101 0110 is sent, then the parity bit would be 1. Odd parity is just the opposite, and the parity bit is 0 when the number of mark bits (1's) in the preceding word is an odd number. Parity error checking is very rudimentary. While it will tell you if there is a single bit error in the character, it doesn't show which bit was received in error. Also, if an even number of bits are in error then the parity bit would not reflect any error at all. No parity ignores the parity bit. When transmitted, each character is preceded by a start bit and followed by a stop bit plus an optional parity bit, making train of 10 or 11 bits for each transmitted character. The **Figure 2.1** below shows transmission of the 7 bits of the ASCII lower case "c" with start, stop and even parity bits.

• **Baud Rate**

The baud rate refers to the data transmission. It specifies the communication rate over the bus. When a change in signal represents one data bit, baud rate is equal to bits per second (bps). Standard baud rates for computers are 300, 600, 1200,2400, 4800, 9600 and 19200 baud.

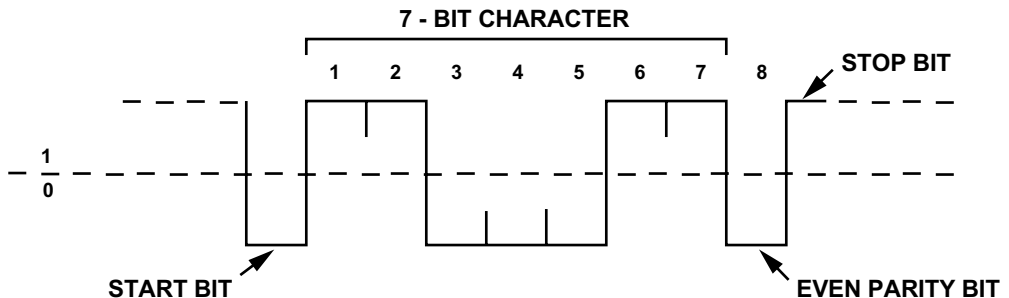

Figure 2.1 Transmission of "c" with start, stop, and even parity bits.

• **Communication Protocol**

A data communication protocol defines the rules and structure of messages used by all devices on a network for data exchange. This protocol also defines the orderly exchange of messages, and the detection of errors. iSeries controllers use iSeries and MODBUS communication protocols.

PART 3 HARDWARE

3.1 Communication Interfaces

Two communication interfaces are supported in the iSeries devices: RS-232 and RS-485. These standards define the electrical characteristics of a communication network.

- The **RS-232** standard (**point-to-point**) allows a single device to be connected to a PC. The iSeries devices operate with full-duplex RS-232 using three wires: a Rx - receive wire, a Tx - transmit wire and a common ground wire. RS-232 cable length is limited to 50 feet.
- The **RS-485** standard (**multipoint**) allows one or more devices to be connected (multi-dropped) using a two wire connection (half-duplex) +Rx / +Tx and -Rx / -Tx. Use of RS-485 communications allows up to 32 “remote” devices to connect to the “master” computer with cable length up to 4000 feet long.
- Both interfaces use standard RS-232/RS-485 voltage levels.

 Although the RS-485 is commonly referred to as a “two wire” connection, the iSeries also provides a ground / return shield connection to use as a common connection for EMI noise protection.

The **Table 3.1** shows the differences between RS-232 and RS-485 communication interfaces.

Table 3.1 Communication Interfaces

Data Transmission Characteristics	RS232	RS485
Transmission Mode	Single ended	Differential
Electrical connections	3 wire	2 wire
Drivers per line	1 driver	32 drivers
Receivers per line	1 receiver	32 receiver
Maximum data rate	20k bits/s	10M bits/s
Maximum cable length	50 ft (15 meters)	4000 ft (1200 meters)

 Changing between RS-232 and RS-485 is possible through front panel buttons (see Part 4 for details).

3.2 Wiring RS-232 Interface

Most PC's provide an RS-232 port for digital communication. The RS-232 communication uses three wire full-duplex system: a line for receiving data, a line for transmitting data and a common line between the computer and device. Usually PCs use a 25 or 9 pin connector.

 **Caution:** Do not connect power to your instrument until you have completed all serial interface connections. Failure to do so may result in injury.

Figures 3.1 and 3.2 show the three-wire RS-232 connections between the host computer using a 9-pin or 25-pin “D” connector and the i-Series device.

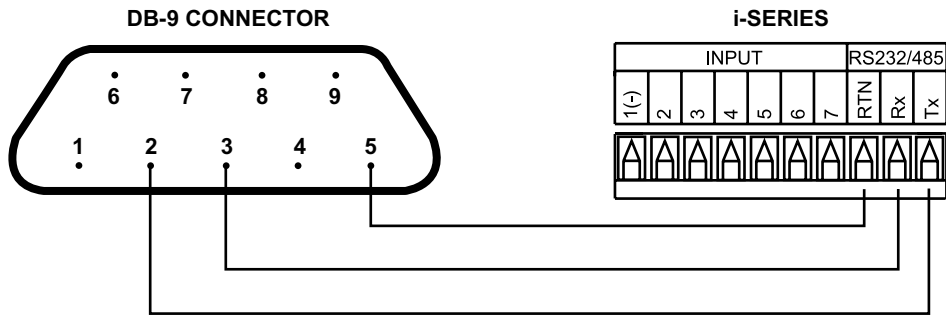

Figure 3.1 Wiring between DB9 computer connector and RS-232 controller interface

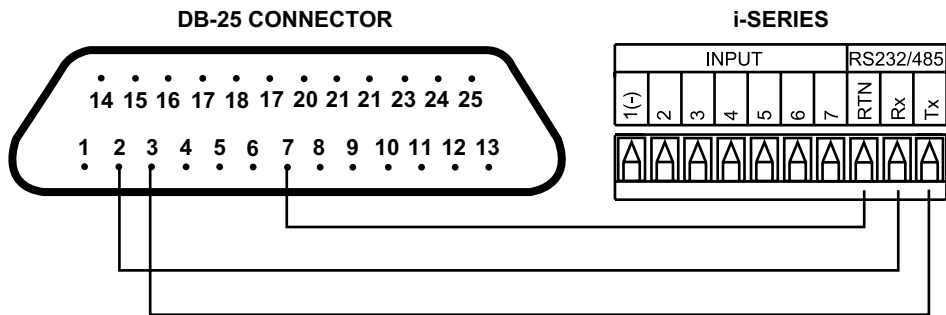

Figure 3.2 Wiring between DB25 computer connector and RS-232 controller interface

Table 3.2 shows the pin connection assignments between the RS-232 connector on the meter and the 9-pin or 25-pin “D” connectors of your computer.

Table 3.2 Wiring RS-232 Interface

PIN FUNCTION	COMPUTER		iSERIES FUNCTION/ LABEL
	DB9	DB25	
Receive (Rx)	2	3	Transmit (Tx)
Transmit (Tx)	3	2	Receive (Rx)
Common ground	5	7	RTN

3.3 Wiring RS-485 Interface

RS-485 interface uses a two wire communication system (one for transmitting and one for receiving) plus a common wire to connect to the shield of a cable. It is recommended to use a shielded cable with one twisted pair.

Note Use of twisted pair and shield will significantly improve noise immunity.

Figure 3.3 shows multipoint, half-duplex RS-485 interface connections for iSeries.

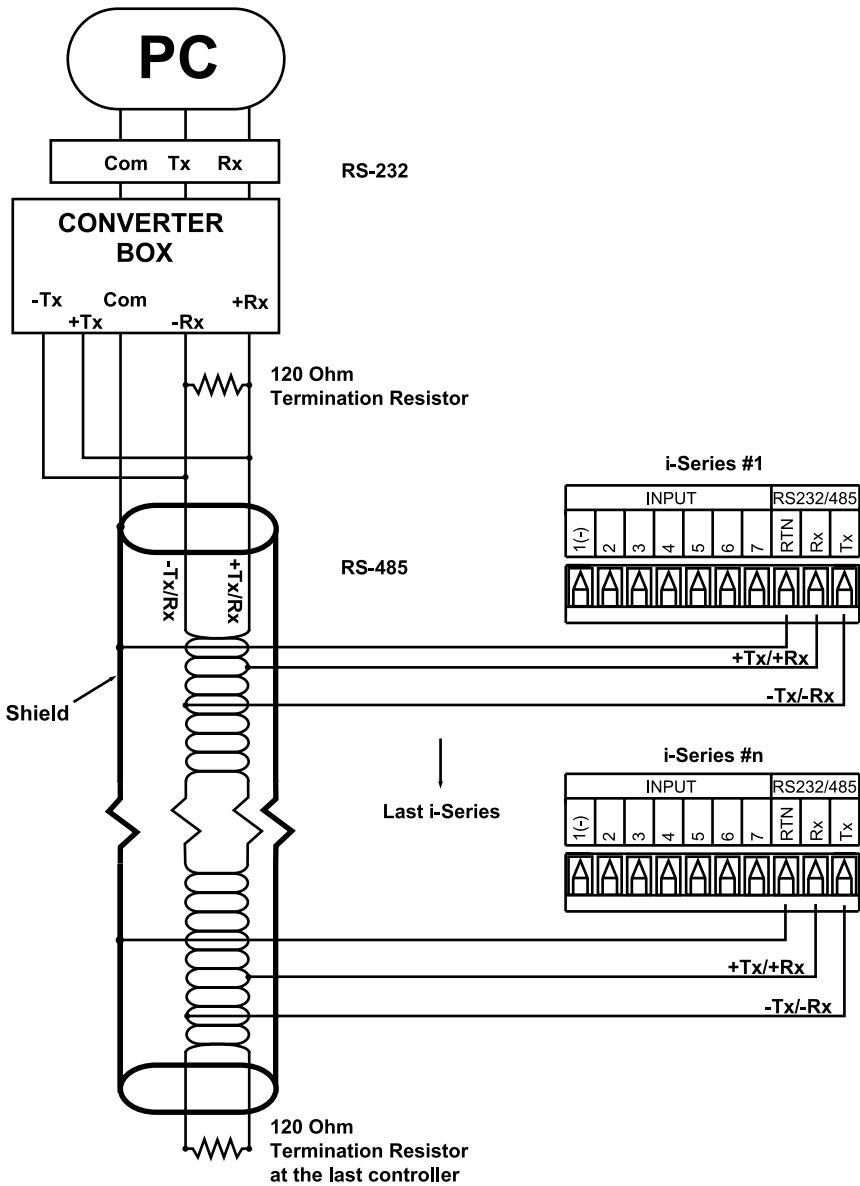

Figure 3.3 Multipoint, Half-Duplex RS-485 wiring



Value of the termination resistor is not critical and depends on the cable impedance.

Table 3.3 shows RS-485 half-duplex hookup using a computer’s RS-232 interface, an RS-485 interface converter, and an iSeries controller.

Table 3.3 RS-485 Half-Duplex Hook-up

COMPUTER			CONVERTER BOX		iSERIES FUNCTION/ LABEL
PIN FUNCTION	DB9	DB25	COMPUTER SIDE	iSERIES SIDE	
Rx/Tx	2	3	SEE CONVERTER’S	-Rx/-Tx	Tx
Rx/Tx	3	2	MANUFACTURING	+Rx/+Tx	Rx
Common ground	5	7	SPECIFICATION	COM	RTN



Communication Interfaces shown above are those which used on iSeries devices. Other types of Communication Interfaces are not covered in this chapter.

PART 4
COMMUNICATION SETUP
4.1 Flow Chart

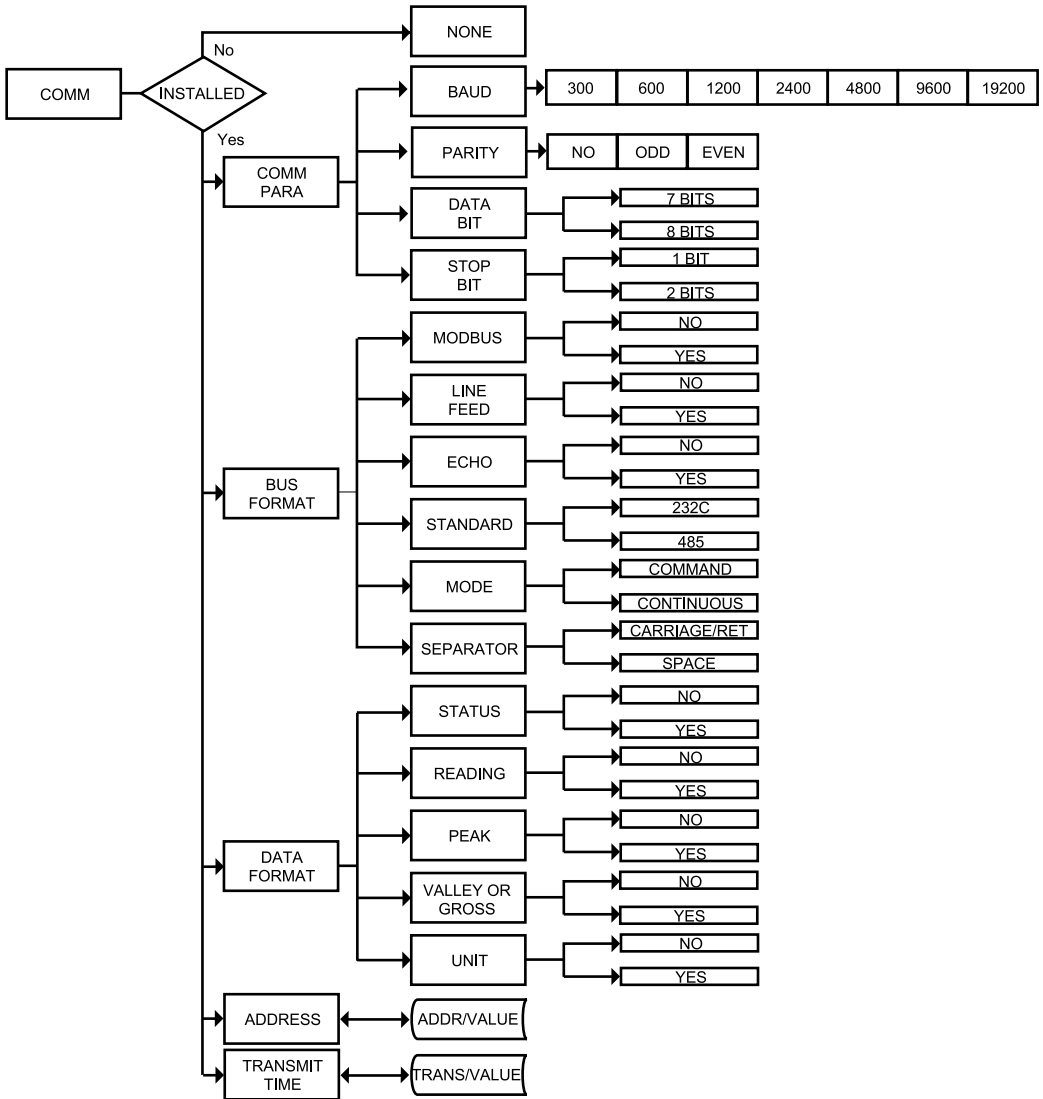

Figure 4.1 Flow Chart for Communication Option

4.2 Setup the iSeries Device Through the Front Panel

You can setup your device by pressing the push buttons on the front panel.

ENTER COMMUNICATION OPTION MENU:

- Press **⏪** 1) Press **⏪** until **CONF** prompt appears.
 Press **⏪** 2) Display advances to **INPE** Input Menu.
 Press **⏪** 3) Press **⏪**, until display advances to **COMM** Communication Options Menu.
 Press **⏪** 4) Display advances to **C.PAR** Communication Parameters Submenu.

- ⏪** - Use **⏪** to advance/navigate through all Communication Menu items.
- ⏩** - Press **⏩** to access the submenus from a top level of Communication Menu item.
Press **⏩** to store a submenu selection.
- ⏴** - Press **⏴** to scroll through “flashing” selection. When a numerical value is displayed, press **⏴** to change a value of this parameter.
- ⏴** - Press **⏴** to go back to a top level of Communication Menu item. Press **⏴** twice to reset the device to Run mode.

4.3 Abbreviations, Range, Default Setup

The Communication Menu Display items use some abbreviations and compact wording shown on **Table 4.1**.

Table 4.1 Abbreviations, Range, Default Setup

Display (abbreviations)	Function	Range/ Definition	Factory Default
C.PAR	Communication Parameter:		
bAUd	Baud rate	300, 600, 1200, 2400 4800, 9600, 19200	9600
PRtY (odd_, EVEN, No)	Parity	Odd, Even, No	odd
dAtA (7.bit, 8.bit)	Data bit	7 bit, 8 bit	7.bit
StOP (1.bit, 2.bit)	Stop bit	1 bit, 2 bit	1.bit
bus.F	Bus format:		
M.bUS	Modbus protocol	Yes – Modbus protocol enabled No – iSeries protocol enabled	No
LF	Line feed	Yes – print on every other line No – print on every line	No
ECHO	Echo	Yes – echo the command parameter No – no echo	_YES
StNd (232C, 485_)	Communication Standard	RS-232, RS-485	232C
ModE (CMd_, CoNt)	Data Flow Mode	Command – operate in Command Mode (respond to valid command). Continuous – operate in Continuous mode (transmit different measurement values continuously on the bus).	CMd_

Abbreviations, Range, Default Setup Continued

SEPR (SPCE, _cR_)	Data Separation Character	Space – space inserted after each piece of data. Carriage Return – carriage return inserted after each piece of data	SPCE
dAt.F	Data Format:		
stAt	Alarm Status	Yes – enables the transmission of Alarms Value No – disable	_No_
RdNG	Reading	Yes – enables the transmission of Reading Value No – disable	_Yes
PEAK	Peak	Yes – enables the transmission of Peak Value No – disable	_No_
VALY *	Valley	Yes – enables the transmission of Valley Value No – disable	_No_
GROS **	Gross	Yes – enables the transmission of Gross Value No – disable	_No_
UNit	Units	Yes – enables the transmission of Units of Measurement No – disable	_No_
AddR	Multipoint Address	0000 to 0199 – Addressed Meter	0001
tR.tM	Transmit Time Interval	0000 to 5999 sec – transmission Time Interval between consecutive transmissions in Continuous Mode.	0016
	Recognition Character	20 Hex to 7F Hex (32 to 127 Dec) (refer to Appendix B) except “A”, “A”, “E”	*

* - For Temperature/Process instrument only

** - For Process/Strain Gauge instrument only

Note 

1. There is no **Continuous** Mode, when device is configured to use the RS-485 interface standard.
2. The **Multipoint Address** will be included in the transmission data if RS-485 standard has been selected in menu items.
3. **Transmit time** is available only when device has configured for Continuous Mode and RS-232 Standard.
4. If the meter is in point-to-point **Continuous Mode**, it ignores any transmitted commands except Ctrl S, which will stop transmission.

Communications Parameters Submenu

Allows the user to adjust Serial Communications settings of the device. When connecting an instrument to a computer or other device, the Communication Parameters must match. Generally the default settings shown in **Table 4.1** should be utilized.

Bus Format Submenu

Determines communications standards and command/data formats for transferring information into and out of the device via the Serial Communications Bus.

Bus Format submenus essentially determine how and when data can be accessed via the Serial Communications of the device.

Data Format Submenu

Preformatted data can be sent automatically or upon request from the device. Use the Data Format Submenus to determine what data will be sent in this preformatted data string. At least one of the Data Format suboptions must be enabled to send output data to the Serial Bus.

Recognition Character

A selectable symbol transmitted as the first character of each message from the computer, which is used for message security: the meter ignores messages without this symbol.

PART 5 iSeries PROTOCOL

 To Enable the iSeries Protocol, set Modbus menu item to “No” in the Bus Format Submenu of the Communication Menu. Refer to Section 5.7.11.

A Data Communication Protocol defines the rules and structure of messages used by all devices on a network for data exchange. A typical transaction will consist of a request to send from the “master” followed by the response from the “slave”.

5.1 Command Structure

The device can be commanded to “Read”, i.e., to transmit (send) data from either the nonvolatile memory (EEPROM) or from the volatile working memory (RAM).

The device can also be commanded to “Write”, i.e., store new values for data processing or control.

There are different command types associated in communicating with your meter shown in **Table 5.1**, which shows the Command Prefix Letters (Command Classes).

Table 5.1 Command Prefix Letters

COMMAND PREFIX (COMMAND CLASS)	MEANING
^AE	Special read, Communication parameters
P (Put)	Write HEX data into RAM
W (Write)	Write HEX data into EEPROM. 1,000,000 writes to EEPROM is guaranteed!
G (Get)	Read HEX data from RAM
R (Read)	Read HEX data from EEPROM
U	Read status byte
V	Read measurement data string in Decimal format
X	Read measurement data values in Decimal format
D	Disable
E	Enable
Z	Reset

5.2 Command Formats

Table 5.2 shows the command formats for iSeries devices.

Table 5.2 Command Formats

For "P" and "W" Command classes:	For "G" and "R" Command classes:	For "X", "V", "U", "D", "E", and "Z" Command classes:
Point-to-point mode * ccc<data><cr>	Point-to-point mode * ccc <cr>	Point-to-point mode * ccc <cr>
Multipoint mode * ncccc [<data>]<cr>	Multipoint mode * ncccc <cr>	Multipoint mode * ncccc <cr>

Where:

"*" is the selected Recognition Character. You may select any ASCII table symbol from "!" (HEX address "21") to the right-hand brace (HEX "7D") except for the caret "^", "A", "E", which are reserved for bus format request.

"ccc" stands for the hex-ASCII Command Class letter (one of eleven given in Table 5.1), followed by the two hex-ASCII Command Suffix characters identifying the meter data, features or menu items to which the command is directed (given in Table 5.3).

"<data>" is the string of characters containing the variable information the computer is sending to the meter. These data (whether BCD or binary) are encoded into hex-ASCII characters, two characters to the byte. Square brackets (indicating optional status) enclose this string, since some commands contain no data.

"<nn>" are the two ASCII characters for the device Bus Address of RS-485 communication . Use values from "00" to hex "C7" (199 decimal).

Table 5.3 and 5.4 shows the command letters and suffix for iSeries devices.

Table 5.3 Command Letters and Suffix for Temperature/Process Instrument

Command	Command Index	Function	Command Bytes	# Of Characters	Default Value
PRW	01	SP1	3	6	200000
PRW	02	SP2	3	6	200000
GPRW	03	RDGOFF	3	6	200000
RW	04	ANLOFF	3	6	400000
RW	05	ID	2	4	0000
-	06	N/A	-	-	-
RW	07	INPUT	1	2	04
GPRW	08	RDGCNF	1	2	4A
RW	09	AL1CNFG	1	2	00
RW	0A	AL2CNFG	1	2	00
RW	0B	LOOP BREAK TIME	2	4	003B
RW	0C	OUT1CNF	1	2	00
RW	0D	OUT2CNF	1	2	60
RW	0E	RAMPTIME	2	4	0000

Command Letters and Suffixes Continued

Command	Command Index	Function	Command Bytes	# Of Characters	Default Value
RW	0F	ANLSCL	3	6	9186A0
RW	10	COMM.PARAMETERS	1	2	0D
RW	11	COLOR	1	2	09
RW	12	AL1LO	3	6	A003E8
RW	13	AL1HI	3	6	200FA0
GPRW	14	RDGSCL	3	6	100001
RW	15	AL2LO	3	6	A003E8
RW	16	AL2HI	3	6	200FA0
GPRW	17	PB1/DEAD BAND	2	4	00C8
GPRW	18	RESET 1	2	4	00B4
GPRW	19	RATE 1	2	4	0000
GPRW	1A	CYCLE 1	1	2	07
-	1B	N/A	-	-	-
GPRW	1C	PB2/DEAD BAND	2	4	00C8
GPRW	1D	CYCLE 2	1	2	07
RW	1E	SOAK TIME	2	4	0000
RW	1F	BUS FORMAT	1	2	14
GPRW	20	DATA FORMAT	1	2	02
RW	21	ADDRESS	1	2	01
RW	22	Transit Time Interval	2	4	0010
-	23	N/A	-	-	-
RW	24	Miscellaneous	1	2	00
RW	25	C.J. OFFSET ADJ.	3	6	200000
RW	26	Recognition Character	1	2	2A
RW	27	%LOW	1	2	00
RW	28	%HI	1	2	63
D	01	DISABLE ALARM 1	0	0	-
D	02	DISABLE ALARM 2	0	0	-
D	03	STANDBY	0	0	-
D	04	DISABLE SELF	0	0	-
E	01	ENABLE ALARM 1	0	0	-
E	02	ENABLE ALARM 2	0	0	-
E	03	DISABLE STANDBY	0	0	-
E	04	ENABLE SELF	0	0	-
X	01	SEND READING	0	0	-
X	02	SEND PEAK READING	0	0	-
X	03	SEND VALLEY READING	0	0	-
U	01	SEND ALARM STATUS	0	0	-
U	03	SEND SW VERSION	0	0	-
V	01	SEND DATA STRING	0	0	-
Z	02	HARD RESET	0	0	-

Table 5.4 Command Letters and Suffix for Process/Strain Gauge Instrument with 10 Linearization Points

Command	Command Index	Function	Command Bytes	# Of Characters	Default Value
PRW	01	SP1	3	6	200000
PRW	02	SP2	3	6	200000
GPRW	03	RDGOFF	3	6	200000
RW	04	ANLOFF	3	6	400000
RW	05	ID	2	4	0000
-	06	N/A	-	-	-
RW	07	INPUT	1	2	04
GPRW	08	RDGCNF	1	2	4A
RW	09	AL1CNFG	1	2	00
RW	0A	AL2CNFG	1	2	00
RW	0B	LOOP BREAK TIME	2	4	003B
RW	0C	OUT1CNF	1	2	00
RW	0D	OUT2CNF	1	2	60
RW	0E	RAMPTIME	2	4	0000
RW	0F	ANLSCL	3	6	9186A0
RW	10	COMM.PARAMETERS	1	2	0D
RW	11	COLOR	1	2	09
RW	12	AL1LO	3	6	A003E8
RW	13	AL1HI	3	6	200FA0
GPRW	14	RDGSCL	3	6	100001
RW	15	AL2LO	3	6	A003E8
RW	16	AL2HI	3	6	200FA0
GPRW	17	PB1/DEAD BAND	2	4	00C8
GPRW	18	RESET 1	2	4	00B4
GPRW	19	RATE 1	2	4	0000
GPRW	1A	CYCLE 1	1	2	07
-	1B	N/A	-	-	-
GPRW	1C	PB2/DEAD BAND	2	4	00C8
GPRW	1D	CYCLE 2	1	2	07
RW	1E	SOAK TIME	2	4	0000
RW	1F	BUS FORMAT	1	2	14
GPRW	20	DATA FORMAT	1	2	02
RW	21	ADDRESS	1	2	01
RW	22	Transit Time Interval	2	4	0010
-	23	N/A	-	-	-
RW	24	Miscellaneous	1	2	00
RW	25	C.J. OFFSET ADJ.	3	6	200000
RW	26	Recognition Character	1	2	2A
RW	27	%LOW	1	2	00
RW	28	%HI	1	2	63

Command Letters and Suffixes Continued

Command	Command Index	Function	Command Bytes	# Of Characters	Default Value
RW	2B	INPUT FOR SCALE 1	3	6	-
RW	2C	INPUT FOR SCALE 2	3	6	-
RW	2D	INPUT FOR SCALE 3	3	6	-
RW	2E	INPUT FOR SCALE 4	3	6	-
RW	2F	INPUT FOR SCALE 5	3	6	-
RW	29	Linearization Points	1	2	00
RW	30	INPUT FOR SCALE 6	3	6	-
RW	31	INPUT FOR SCALE 7	3	6	-
RW	32	INPUT FOR SCALE 8	3	6	-
RW	33	INPUT FOR SCALE 9	3	6	-
RW	34	RDGSCL1/SCALE 1	3	6	-
RW	35	RDGSCL2/SCALE 2	3	6	-
RW	36	RDGSCL3/SCALE 3	3	6	-
RW	37	RDGSCL4/SCALE 4	3	6	-
RW	38	RDGSCL5/SCALE 5	3	6	-
RW	39	RDGSCL6/SCALE 6	3	6	-
RW	3A	RDGSCL7/SCALE 7	3	6	-
RW	3B	RDGSCL8/SCALE 8	3	6	-
RW	3C	RDGSCL9/SCALE 9	3	6	-
RW	3D	RDGOFF1/OFFSET 1	3	6	-
RW	3E	RDGOFF2/OFFSET 2	3	6	-
RW	3F	RDGOFF3/OFFSET 3	3	6	-
RW	40	RDGOFF4/OFFSET 4	3	6	-
RW	41	RDGOFF5/OFFSET 5	3	6	-
RW	42	RDGOFF6/OFFSET 6	3	6	-
RW	43	RDGOFF7/OFFSET 7	3	6	-
RW	44	RDGOFF8/OFFSET 8	3	6	-
RW	45	RDGOFF9/OFFSET 9	3	6	-
D	01	DISABLE ALARM 1	0	0	-
D	02	DISABLE ALARM 2	0	0	-
D	03	STANDBY	0	0	-
D	04	DISABLE SELF	0	0	-
E	01	ENABLE ALARM 1	0	0	-
E	02	ENABLE ALARM 2	0	0	-
E	03	DISABLE STANDBY	0	0	-
E	04	ENABLE SELF	0	0	-
X	01	SEND READING	0	0	-
X	02	SEND PEAK READING	0	0	-
X	03	SEND VALLEY READING	0	0	-
U	01	SEND ALARM STATUS	0	0	-
U	03	SEND SW VERSION	0	0	-
V	01	SEND DATA STRING	0	0	-
Z	02	HARD RESET	0	0	-

Note 

After modifying any settings with use of **W** prefix commands, a Hard Reset command should be sent in order to load changes into Volatile memory.

Examples:

1. To reset the controller, send ***Z02** (Table 5.3 and 5.4)
2. To read Setpoint 1, send ***R01** (Table 5.3 and 5.4)
3. To change Setpoint 1 to 100.0, send ***W012003E8** (see explanation below)

Description: SETPOINT.23~0 means 3 bytes x 8 bit positions
 (2 hex. character in each byte)
 Where 23~0 are 3 x 8 = 24 Binary bit positions

SETPOINT.23 =	SETPOINT.22~20 =	SETPOINT.19~0 =
0 = positive sign	000 – Not Allowed	Setpoint data
1 = negative sign	001 – Decimal Point 1 (FFFF.)	
	010 – Decimal Point 2 (FFF.F)	
	011 – Decimal Point 3*(FF.FF)	
	100 – Decimal Point 4*(F.FFF)	
	*Process only	

For 100.0: Positive sign = 0, Decimal Point 2 = 010 Bin, Setpoint data 1000 = 3E8 Hex = 001111101000 Bin

The command data = 0010 0000 0000 0011 1110 1000 Bin = 2003E8 Hex.
 2 0 0 3 E 8 Hex

Send ***W01 20 03E8**

where:

***W01** - ***<ccc>** - write to Setpoint 1 (Table 5.2)

2003E8 - **<data>** - Setpoint data in hexadecimal format including sign and decimal point (Table 5.2)

Note 

No spaces are allowed in the data string. The spaces shown on the above example for illustration purpose only.

Note 

Decimal Point position for TC/RTD = 1 or 2, for PROCESS = 1, 2, 3, or 4

Note 

Decimal Point position for Set Point should be the same as Decimal Point position sets for process value and can not be overwritten by SETPOINT command (see RDGCNG command, described in 5.7.2).

4. To change Setpoint 1 to -100.0, send ***W01A003E8** (see explanation below)

For (-100.0): Negative sign = 1, Decimal Point 2 = 010 Bin, Setpoint data

1000=3E8 Hex = 001111101000 Bin

The command data = 1010 0000 0000 0011 1110 1000 Bin = A003E8 Hex
 A 0 0 3 E 8 Hex

Send ***W01A003E8**

5. To send the same as above for RS-485 with transmit address 01, the command is **Send *01W01A003E8.**

5.3 Response Format

Table 5.5 and 5.6 show response format with ECHO and without ECHO Mode selection.

Table 5.5 Echo Mode

For “P” and “W” Command classes:	For “G” and “R” Command classes:	For “X”, “V” and “U” Command classes:	For “D”, “E” and “Z” Command classes:
Point-to-point mode ccc<cr> Multipoint mode nnccc <cr>	Point-to-point mode ccc<data> <cr> Multipoint mode nnccc<data> <cr>	Point-to-point mode ccc<value><cr> Multipoint mode nnccc<value><cr>	Point-to-point mode ccc<cr> Multipoint mode nnccc<cr>

Examples:

1. Sent: ***W012003E8** (Change Setpoint 1 to 100.0- see example above)
Response: **W01**
2. Sent ***R01** (Read Setpoint 1, which set to 100.0)
Response: **R012003E8**
3. Sent: ***X01** (Controller reads 75.4 F and Units set to “No”)
Response: **X01075.4**
4. Sent: ***E02** (Enable Alarm 2)
Response: **E02**

Table 5.6 No ECHO Mode

For “P” and “W” Command classes:	For “G” and “R” Command classes:	For “X”, “V” and “U” Command classes:	For “D”, “E” and “Z” Command classes:
Point-to-point mode No Response Multipoint mode No Response	Point-to-point mode <data> <cr> Multipoint mode <data> <cr>	Point-to-point mode <value><cr> Multipoint mode <value><cr>	Point-to-point mode No Response Multipoint mode No Response

Examples:

1. Sent: ***W012003E8** (Change Setpoint 1 to 100.0 - see example above)
Response: **No Response**
2. Sent ***R01** (Read Setpoint 1, which set to 100.0)
Response **2003E8**
3. Sent: ***X01** (Controller reads 75.4 F and Units set to “No”)
Response: **075.4**
4. Sent: ***E02** (Enable Alarm 2)
Response: **No Response**



<data> in Hexadecimal format, except “U” command class, <value> reading in Decimal format

5.4 Error Message

The instrument is capable of detecting different errors during the Communication process and will transmit an indicating messages in **Table 5.7** to the host computer.

Table 5.7 Error Message

	ERROR MESSAGE	CODE
1	Command Error	?43
2	Format Error	?46
3	Parity Error	?50
4	Serial Device Address Error	?56

Where:

1. COMMAND ERROR occurs when:
 - a. Command prefix letter is not valid.
 - b. Command suffix is not valid.
2. FORMAT ERROR occurs when:
 - a. Length of message is either shorter than it should be.
 - b. Any other characters than “0 – F” used for hexadecimal values.
3. PARITY ERROR occurs when transmitted parity does not match with parity set on the receiver.
4. Serial Device Address Error occurs if the new value is larger than 199 decimal.

Note

1. The iSeries device will not respond to a command if the command's recognition character does not match the meter's recognition character.
2. When in Multipoint mode, the device will not respond to the command if addresses do not match.
3. If the device is in the Menu or Setpoint Mode and receives any transmitted data, it quits that routine, displays **COMM** for up to 2 seconds, completes its Communication job, and then resets the device, i.e., hard reset.

5.5 Alarm Status Characters

The meter upon receiving U01 Command will transmit alarm status characters **Table 5.8** shows the transmitted character for each of possible setpoint/alarm states.

Table 5.8 Alarm Status Characters

CHARACTER	Alarm1	Alarm2
@	OFF	OFF
A	ON	OFF
B	OFF	ON
C	ON	ON

5.6 Examples of Transmitted Data

1. The following menu items have been selected:

Standard – RS-232, Mode – Continuous, Linefeed – No, Separation – Space, Status - No
Echo – No, Reading – Yes, Valley – Yes, Peak – Yes, Unit of measurement – Yes

Assume that instrument has the following data:

Reading value = 74.2°F, Peak value = 75.1°F, Valley value = 73.2°F

Alarm 1 – OFF, Alarm 2 - OFF

Instrument will transmit: **74.2 75.1 73.2 F**

2. The following menu items have been changed: Separation – Carriage Return

Instrument will transmit: **74.2
75.1
73.2 F**

3. The following menu items have been changed: Alarm Status – Yes

Instrument will transmit: **@
74.1
75.1
73.2 F**

4. The following menu items have been changed: ECHO – Yes, Alarm 1 - ON

Instrument will transmit: **V01
A
74.2
75.1
73.2 F**

5.7 Command Formats

The following conditions are assumed in the examples of this section.

1. The recognition character is the asterisk (*).
2. The meter use RS-232 interface standard (point-to-point communication).
3. When "W" command is given, a reset is necessary to initiate the command.
4. Each byte consist of 8 bits.
5. " " (blank) in bit pattern information means the bit is not applicable to that parameter.

Note

Note that all ranges have been given decimal numbers. To make a data command, the decimal numbers converted into a hex numbers and then the digits of that hex number are encoded into their equivalent ASCII values.

5.7.1 Input Type (Command Index 07)

Description: INPUT.76543210 means 8 bit positions of the Command Data.

5.7.1.1 Input Type Format for Temperature/Process Instrument

BIT POSITION								INPUT CLASS, RANGE OR TYPE		
7	6	5	4	3	2	1	0			
						0	0			TC (Thermocouple)
						0	1			RTD
						1	0			PROCESS
										TC
										RTD
										PROCESS
		0	0	0	0				J	392.2 0-100 mV
		0	0	0	1				K	392.3 0-1 V
		0	0	1	0				T	392.4 0-10 V
		0	0	1	1				E	385.2 0-20 mA
		0	1	0	0				N	385.3
		0	1	0	1				DIN-J	385.4
		0	1	1	0				R	
		0	1	1	1				S	
		1	0	0	0				B	
		1	0	0	1				C	
		1	1	0	0					
0	0									100 ohm RTD
0	1									500 ohm RTD
1	0									1000 ohm RTD

Example: Set RTD, 4 wire, .0392 Curve, 100 ohms.

The command data is 00001001 Bin = 09HEX. Send: *W0709

Note

Send a Read command first to determine the bits, which are not specified for some positions (TC and Process for positions 7,6 above).

5.7.1.2 Input Type Format for Process/Strain Gauge Instrument

BIT POSITION								INPUT CLASS, RANGE OR TYPE
7	6	5	4	3	2	1	0	
						0	0	Voltage 0 ~ 100 mV
						0	1	Voltage 0 ~ 1 V
						1	0	Voltage 0 ~ 10 V
						1	1	Voltage 0 ~ 20 mA
					0			Ratio Disable
					1			Ratio Enable
				0				Low Resolution
				1				High Resolution
			0					Peak Value
			1					Gross Value

Example: Set Voltage 0 ~ 100 mV, Ratio Enabled, Low Resolution, Gross Value
The command data is 00010100 Bin = 14HEX. Send: *W0714



Send a Read command first to determine the bits, which are not specified for some positions (positions 7,6 and 5 above).

5.7.2 Reading Configuration: (Command Index 08)

Description: RDGCNG.76543210 means 8 bit positions of the Command Data.

5.7.2.1 Reading Configuration Format for Temperature/Process Instrument

BIT NUMBER								FUNCTION
7	6	5	4	3	2	1	0	
					0	0	0	Not Allowed
					0	0	1	Decimal Point 1 (FFFF)
					0	1	0	Decimal Point 2 (FFF.F)
					0	1	1	Decimal Point 3 (FF.FF)
					1	0	0	Decimal Point 4 (F.FFF)
				0				°C
				1				°F
0	0	0						Filter Constant 1
0	0	1						Filter Constant 2
0	1	0						Filter Constant 4
0	1	1						Filter Constant 8
1	0	0						Filter Constant 16
1	0	1						Filter Constant 32
1	1	0						Filter Constant 64
1	1	1						Filter Constant 128

Example: Set Decimal point 1, °C, Filter constant 16.
The command data is 1000001Bin = 81Hex. Send: *W0881

5.7.2.2 Reading Configuration Format for Process/Strain Gauge Instrument

BIT NUMBER								FUNCTION
7	6	5	4	3	2	1	0	
					0	0	0	Not Allowed
					0	0	1	Decimal Point 1 (FFFF)
					0	1	0	Decimal Point 2 (FFF.F)
					0	1	1	Decimal Point 3 (FF.FF)
					1	0	0	Decimal Point 4 (F.FFF)
				0				Load (On line Cal) Disable
				1				Load Enable
0	0	0						Filter Constant 1
0	0	1						Filter Constant 2
0	1	0						Filter Constant 4
0	1	1						Filter Constant 8
1	0	0						Filter Constant 16
1	0	1						Filter Constant 32
1	1	0						Filter Constant 64
1	1	1						Filter Constant 128

Example: Set Decimal point 2, Load Enable, Filter constant 4.
 The command data is 01010010 Bin = 81Hex. Send: *W084A

5.7.3 Linearization Point (Command Index 29)

The data for number of Linearization Points (number of Scales and Offsets) has offset of -2.

Example: Linearization Points 2 (Scale/Offset number 1 is active for the entire range)
 Send: *W2900

Example: Linearization Points 10 (All 9 Scale/Offset are active)
 Send: *W2908

5.7.4 Color Display (Command Index 11)

Description: CLR.76543210 means 8 bit positions of the Command Data.

BIT NUMBER								FUNCTION
7	6	5	4	3	2	1	0	
		0	0					Alarm 2 Color AMBER
		0	1					Alarm 2 Color GREEN
		1	0					Alarm 2 Color RED
				0	0			Alarm 1 Color AMBER
				0	1			Alarm 1 Color GREEN
				1	0			Alarm 1 Color RED
						0	0	Normal Color AMBER
						0	1	Normal Color GREEN
						1	0	Normal Color RED

Example: Set Normal color green, Alarm 1 color red, Alarm 2 color amber
The command data is 00001001Bin = 09Hex. Send *W1109

5.7.5 Alarm 1 Configuration (Command Index 09)

Description: ALR1CNG.76543210 means 8 bit positions of the Command Data.

BIT NUMBER								FUNCTION
7	6	5	4	3	2	1	0	
0								Alarm 1 at Power On Disable
1								Alarm 1 at Power On Enable
	0							Loop Break Time Disable
	1							Loop Break Time Enable
		0	0					Active Above
		0	1					Active Below
		1	0					Active Hi/Lo
		1	1					Active Band (Deviation only)
				0				Normally Open
				1				Normally Closed
					0			Unlatch
					1			Latch
						0		Absolute
						1		Deviation
							0	Disable Alarm 1 / Retransmission
							1	Enable Alarm 1 / Retransmission

Example: Set Alarm 1 Enable, Deviation, Unlatch, N.C., Band, Loop Disable, Alarm at Power On Enable. The command data is 10111011Bin = BBHex.
Send: *W09BB

5.7.6 Alarm 1 Low (Command Index 12)

Description: AL1LO.23~0 means 3 bytes x 8 bit positions of the Alarm Low Data

AL1LO.23 =	AL1LO.22~20 =	AL1LO.19~0 =
0 = positive sign	000 – Not Allowed	Setpoint data
1 = negative sign	001 – Decimal Point 1 (FFFF.)	
	010 – Decimal Point 2 (FFF.F)	
	011 – Decimal Point 3*(FF.FF)	
	101 – Decimal Point 4*(F.FFF)	
	*Process only	

Example: Set Alarm 1 Low value to -50.0
 The command data is 10100000000000111110100Bin = A001F4Hex.
 Send: *W12A001F4

 **Note:** To set the Decimal Point for proper position see command format for RDGCNF (command index 08).

5.7.7 Alarm 2 Configuration (Command Index 0A)

Description: ALR2CNG.76543210 means 8 bit positions of the Command Data.

BIT NUMBER								FUNCTION
7	6	5	4	3	2	1	0	
0								Voltage Retransmission
1								Current Retransmission
		0	0					Active Above
		0	1					Active Below
		1	0					Active Hi/Lo
		1	1					Active Band (Deviation only)
				0				Normally Open
				1				Normally Closed
					0			Unlatch
					1			Latch
						0		Absolute
						1		Deviation
							0	Disable
							1	Enable

Example: Set Alarm 2 Enable, Absolute, Latch, N.O.,Above, Current Retransmission.
 The command data is 10000101 Bin = 85Hex. Send: *W0A85

 **Warning:** If you change the “0A” to “00” on units with Isolated Analog Output it will disable the Alarm 2 menu.

5.7.8 Output 1 Configuration (Command Index 0C)

Description: OUT1CNG.76543210 means 8 bit positions of the Command Data.

BIT NUMBER								FUNCTION
7	6	5	4	3	2	1	0	
		0						Auto Tune PID Stop
		1						Auto Tune PID Start
			0					Anti Wind Up Disable
			1					Anti Wind Up Enable
					0			Auto PID Disable
					1			Auto PID Enable
						0		Reverse
						1		Direct
	0							Analog Proportional 0 – 20 mA
	1							Analog proportional 4 – 20 mA
							0	Time Proportional On/Off
							1	Time Proportional PID

Example: Set PID, Direct, Auto PID Enable, Anti Integral Enable, Auto PID Stop.
The command data is 00010111Bin = 2Fhex. Send: *W0C17

5.7.9 Output 2 Configuration (Command Index 0D)

Description: OUT2CNG.76543210 means 8 bit positions of the Command Data.

BIT NUMBER								FUNCTION
7	6	5	4	3	2	1	0	
0	0	0						Damping 0
0	0	1						Damping 1
0	1	0						Damping 2
0	1	1						Damping 3
1	0	0						Damping 4
1	0	1						Damping 5
1	1	0						Damping 6
1	1	1						Damping 7
			0					Soak Disable
			1					Soak Enable
				0				Ramp Disable
				1				Ramp Enable
					0			Auto PID Disable
					1			Auto PID Enable
						0		Reverse
						1		Direct
							0	Time Proportional On/Off
							1	Time Proportional PID

Example: Set On/Off, Reverse, Auto PID Disable, Ramp Disable, Soak Disable,
Damping 4. The command data is 10000101Bin = 80Hex. Send: *W0D85

5.7.10 Communication Parameters (Command Index 10)

Description: COMM.PAR.76543210 means 8 bit positions of the Command Data.

BIT NUMBER								FUNCTION
7	6	5	4	3	2	1	0	
	0							1 Stop Bit
	1							2 Stop Bit
		0						7 Bit
		1						8 Bit
			0	0				No Parity
			0	1				Odd
			1	0				Even
					0	0	0	300 Baud
					0	0	1	600
					0	1	0	1200
					0	1	1	2400
					1	0	0	4800
					1	0	1	9600
					1	1	0	19200

Example: Set Baud Rate 9600, Odd Parity, 7 Bit, 1 Stop.

The command data is 00001101Bin = 0Dhex. Send: *W100D

5.7.11 Bus Format (Command Index 1F)

Description: BUSFORMAT.76543210 means 8 bit positions of the Command Data.

BIT NUMBER								FUNCTION
7	6	5	4	3	2	1	0	
		0						Space
		1						Carriage Return
			0					Continuous
			1					Command
				0				RS-232
				1				RS-485
					0			NO ECHO
					1			ECHO
						0		No Line Feed
						1		Line Feed
							0	No Modbus
							1	Modbus

Example: Set Space, Continuous, RS-232, Echo, Line Feed, N/A

The command data is 00000110Bin = 06Hex. Send *W1F06

5.7.12 Data Format (Command Index 20)

Note DATAFORMAT is used for V01 command or continuous mode (RS-232)

Description: DATAFORMAT.76543210 means 8 bit positions of the Command Data.

BIT NUMBER								FUNCTION
7	6	5	4	3	2	1	0	
	0							No Unit
	1							Unit
				0				No Valley or Gross
				1				Valley or Gross
					0			No Peak
					1			Peak
						0		No Reading
						1		Reading
							0	No Alarm Status
							1	Alarm Status

Example: Set ID, Unit, No Valley, No Peak, Reading, No Status.
The command data is 11000010Bin = C2Hex. Send: *W20C2

Note ADDRESS is applicable for RS-485 standard only and can be 01 to 199

Note TRANSMIT TIME INTERVAL is applicable for RS-232 standard and Continuous Mode, which specifies the time between transmission and the minimum time is 500 msec.

5.7.13 Miscellaneous (Command Index 24)

Description: MISCELLANEOUS.76543210 means 8 bit positions of the Command Data.

BIT NUMBER								FUNCTION
7	6	5	4	3	2	1	0	
	0							SP Deviation Disable
	1							SP Deviation Enable
			0					Self Disable
			1					Self Enable
				0				Full ID Disable
				1				Full ID Enable
					0			Set Point ID Disable
					1			Set Point ID Enable

Example: Set SP Enable, Self Disable, Full ID Enable, Set Point ID Disable.
The command data is 10001000Bin = 88Hex. Send: *W2088

5.7.14 % Low and % Hi (Command Indexes 27 and 28)

Note Make sure the values of % Low and % Hi submenus are entered correctly (% Hi can't be more than 99% or % Hi should be always more than % Low). If values entered incorrectly, instrument will reset these values to factory defaults (% Low = 0, % Hi = 99 (63 Hex))

5.7.15 Reading Scale and Offset (Command Indexes 14 and 3A)

Description: RDGOFF.23~16, 15~8, 7~0 means 3 bytes x 8 bit positions of the Reading Offset
RDGSC.23~16, 15~8, 7~0 means 3 bytes x 8 bit positions of the Reading Scale

RDGOFF.23 =
0 positive offset
1 negative offset

RDGOFF.22~20 =
DP+2

RDGOFF.19~0 =
offset data

RDGSC.23~20 =
DP+1

RDGSC.19 =
0 direct scale
1 reverse scale

RDGSC.18~0 =
scale data

Example: To have an input of 4 to 20 mA displayed as 0 to 100

Note First make sure that Decimal Point on your device is set to the proper position. Then, disregard the decimal point position through Scale and Offset calculation. For instance: to display 0 to 100 set decimal point into position 1 (FFFF); to display 0 to 100.0 set decimal point into position 2 (FFF.F) then, perform Scale and Offset calculation to display 0 to 1000.

The Low input value = min. input value * conversion number = 4(mA) x 500 = 2000

The High input value = max. input value * conversion number = 20(mA) x 500 = 10000 (9999)

where: conversion number is a coefficient of conversion between input values and real display range.

The full range of the display = 10000, conversion number = 10000/20 = 500

See **Table 5.9** below for proper conversion number

Table 5.9 Conversion Number

INPUT RANGE	CONVERSION NUMBER
0 ~ 100 mV	$10000 / (100 \times 1) = 100 \text{ cts/mV}$
0 ~ 1 V	$10000 / (1000 \times 1) = 10 \text{ cts/mV}$
0 ~ 10 V	$10000 / (1000 \times 10) = 1 \text{ cts/mV}$
0 ~ 20 mA	$10000 / (20 \times 1) = 500 \text{ cts/mA}$

Scaling:

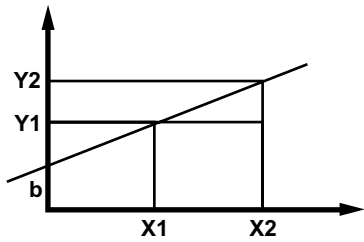

$$Y = mX + b$$

WHERE: m - SLOPE (SCALE)
 b - OFFSET

$$m = \frac{(Y2 - Y1)}{(X2 - X1)}$$

To remap 4 – 20 mA to a displayed reading from 0 to 100 then use slope:

$$\text{Slope (Scale)} = \frac{\text{Rd2} - \text{Rd1}}{\text{In2} - \text{In1}}$$

where: Rd2 – Hi Display reading (100), Rd1 – Low Display reading (0)
In2 – Hi Input (20 x 500), In1 – Low Input (4 x 500)

1. Obtain a Scale Factor

$$\text{Scale} = (100-0) / (9999-2000) = 0.0125016$$

2. Rewrite the Scale Factor as an integer times an exponent

$$0.0125016 = 125016 \text{ E } -7$$

3. Then Encode these values

125016 Dec = 1E858 Hex - Reading Scale Data
(RDGSC.18 ~ 0 value stored into bits 0 - 18);

E -7 is represented as RDGSC.23 ~ 20 = 8 (DP = 7);
Direct Scale is represented as RDGSC.19 = 0 (direct scale);

Binary Code:

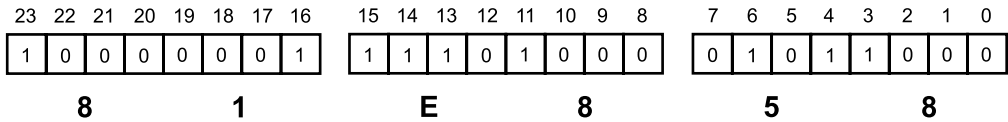

Send command: *W1481E858 (scale = 81E858)

Offset:

Offset is found in the following equation: Reading = Scale x Input value + Offset (Y=mX+b)
 or the equation can be rewritten as: Offset = Reading – Scale x Input Value (b=Y-mX)

1. Obtain the Offset Factor

$$\text{Offset} = 100 - (0.0125 \times 10000) = (-25)$$

2. Rewrite the Offset Factor as an integer times an exponent

$$-25 \times E0$$

3. Then encode these values

25 Dec = 00019 Hex Offset Data (RDGOFF.19 ~ 0 value stored into bits 0 – 19)

E0 is represented as RGDOFF.22 ~ 20 = 2 (DP+2=0+2)

Offset is negative represented RDGOFF.23 = 1

Binary Code:

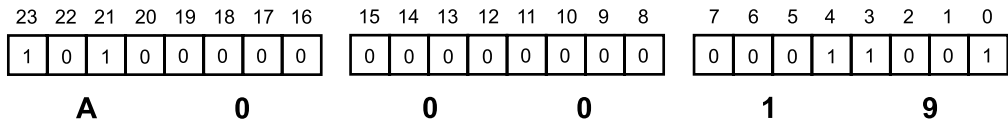

Send command: *W03A00019 (offset=A00019)



See **Appendix A** for Reading Scale and Offset of Process/Strain Gage Instrument with 10 Linearization Points

5.7.16 Grouping Commands with the Same Formats

1. The following are of the same format as the Alarm 1 Low data format: Set Point 1 (command index 01), Set Point 2 (command index 02), Alarm 1 High (command index 13), Alarm 2 Low (command index 15), Alarm 2 High (command index 16), C.J. Offset Adjustment (command index 25).
2. There are two commands using the same Scale-Type format:
Reading Scale (command index 14) and Analog Output Scale (command index 0F)
3. There are two commands using the same Offset-Type format:
Reading Offset (command index 03) and Analog Output Offset (command index 04)
4. **Table 5.10** below shows the simple natural numbers, which have a simple data format.

Table 5.10 Commands with Numeric Data Format

Command index	Function	# of characters	Range
05	ID Code	2	0 ~ 9999
22	Transmit Time Interval	4	0 ~ 1999 (0 = 500 ms)
1A	Cycle 1	2	1 ~ 199 Sec
1D	Cycle 2	2	1 ~ 199 Sec
21	Address	2	1 ~ 199
17	PB1/Dead Band 1	4	0 ~ 9999 Counts
1C	PB1/Dead Band 2	4	0 ~ 9999 Counts
18	Reset 1	4	0 ~ 3999 Sec
19	Rate 1	4	0 ~ 3999 Sec
27	%Low	2	0 ~ 98%
28	%High	2	0 ~ 99%

Example: Set Proportional Band 1 (PB 1) to 150
The command data = 0096Hex. Send: *W170096

5. Time Formats:
 Loop Break Time Value MM * 100 + SS (encoded as a 4 digit hex number)
 Ramp Time HH * 100 + MM (encoded as a 4 digit hex number)
 Soak Time HH * 100 + MM (encoded as a 4 digit hex number)

Example: Set Loop Break Time to 10 minutes 25 seconds (10:25)
The command data = 0401Hex. Send: *W0B0401

 To communicate when the Continuous Mode is enabled, the Continuous Mode must be stopped by sending Ctrl S (Xoff) and then send ^AE

PART 6 MODBUS PROTOCOL

 To Enable the Modbus Protocol, set Modbus menu item to “**Yes**” in the Bus Format Submenu of the Communication Menu.

6.1 Introduction

Modbus Protocol defines a message structure that iSeries devices will recognize and use, regardless of the type of networks over which they communicate. It describes the process a device uses to request access to another device, how it will respond to requests from the other devices, and how errors will be detected and reported. It establishes a common format for the layout and contents of message fields.

The Modbus Protocol provides the internal standard that the iSeries devices use for parsing messages. During communications on a Modbus network, the protocol determines how each instrument will know its device address, recognize a message addressed to it, determine the kind of action to be taken, and extract any data or other information contained in the message. If a reply is required, the iSeries will construct the reply message and send it using Modbus protocol.

Modbus defines a digital communication network to have only one MASTER and one or more SLAVE devices. Either a single (point-to-point) or multi-drop network (multipoint) is possible.

iSeries devices communicate on standard Modbus networks using RTU (Remote Terminal Unit) transmission mode.

 When you set your iSeries to Modbus, the serial communication settings change to: Baud Rate: **9600**, Data Bit: **8**, Stop Bits: **1**, Parity: **None**. However, if you set your iSeries to Modbus through the Configuration Software these changes also take place, but the display and software page will still show the default settings of : **9600, 7, 1, Odd**.

6.2 RTU Mode

In RTU Mode, each eight-bit byte in a message contains two four-bit hexadecimal characters. The main advantage of this mode is that its greater character density allows better data throughput than ASCII for the same baud rate. Each message must be transmitted in a continuous stream.

The following format used for each byte sent and received by iSeries instrument in RTU Mode:

1. Eight-bit binary, Hexadecimal (0 ... 9, A ... F)
2. Two hexadecimal characters contained in each eight-bit field of the message
3. 1 start bit, 8 data bits, 1 Stop Bit (No Parity Bit)

The figure below shows the bit sequences when byte transmitted in RTU Mode.

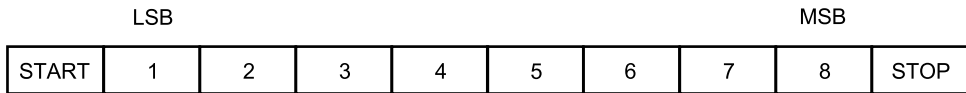

LSB – Least Significant bit sent first
 The Modbus Message frame is shown below

DEVICE ADDRESS	FUNCTION CODE	DATA	CRC CHECK
8 BITS nn	8 BITS nn	k x 8 BITS nnn...	16 BITS nnnn

where: n – character, k – integers depend on the contents of the data format.

6.3 Device Address

The address message frame contains eight bits. The slave device addresses are in the range of 1 ... 199 decimal. A master addresses a slave by placing the slave address in the address field of the message. When the slave sends its response, it places its own address in this address field of the response to let the master know which slave is responding. Address 0 is used for the write command broadcast that commands all devices on network, which all slave devices recognize.

6.4 Function Code

The function code field of a message frame contains eight bits (RTU). Valid codes are in the range of 1 ... 255 decimal. Of these, some codes are applicable for iSeries controllers. When a message is sent from a master to a slave device the function code field tells the slave what kind of action to perform.

The following functions are supported by iSeries devices:

Table 6.1 Function Code

Function Code	Function	Description
03	Read holding register	Reads the binary contents of holding registers in the slave
04	Read input register	Reads the binary contents of input register in the slave.
06	Preset (Write to) single register	Preset (Write) a value into single holding register
08	Diagnostic	Series of tests for checking communication between master and slave

When the slave responds to the master, it uses the function code field to indicate either a normal (error-free) response or that some kind of error occurred (called an exception response). For a normal response, the slave simply echoes the original function code. For an exception response, the slave returns a code that is equivalent to the original function code with its most significant bit set to a logic 1.

6.5 Data Field

The data field is constructed using sets of two hexadecimal digits, in the range of 00 to FF hexadecimal. The data field of messages sent from a master to slave devices contains additional information, which the slave must use to take the action defined by the function code. This can include items like discrete and register addresses, the quantity of items to be handled, and the count of actual data bytes in the field.

6.6 CRC Checking

With RTU Mode the error checking field contains a 16-bit value implemented as two eight-bit bytes (High order byte and Low order byte). The error check value is the result of a Cyclical Redundancy Check (CRC) Calculation performed on the message contents. After building a message (address, function code, data) the transmitting device calculates a CRC Code and puts it to the end of the message. A receiving device will calculate a CRC Code from the message it has received and compare against transmitted CRC Code. If these CRC Codes are different, there has been a communication error. iSeries devices will not reply if they detect a CRC Error.

Sequences of CRC calculation:

1. Load a 16 bit CRC register with all 1's.
2. Apply first 8 bit byte of the message to the low order byte (LB) of the contents of the register.
3. Exclusive OR these 8 bit with the register contents.
4. Shift the result one bit to the right with zero entering into the high order byte (HB) position and evaluate the LB.
5. If over flow bit in LB is 1, exclusive OR the latest register contents with A001 Hex value.
6. If over flow bit in LB is 0, no exclusive OR occurs (repeat step 4).
7. Repeat steps 4, 5 and 6 until 8 shifts have been performed.
8. Apply next 8 bit byte of the message to the LB contents of the register.
9. Exclusive OR these 8 bit with the register contents.
10. Repeat steps 4 to 9 until all bytes of the message have been processed.
11. The final content of the register is the CRC value.

Examples of CRC calculation sees in **Appendix B**

Note

When CRC is placed into the end of the message, the low order byte of the CRC will be transmitted first, followed by the High order byte.

6.7 Modbus RTU Registers

The table below shows the Modbus registers supported by iSeries devices.

Table 6.2 Modbus Registers

FUNCTION CODE	REGISTER	FUNCTION	VALUE, RANGE (Decimal)
NO	0	N/A	
03/04, 06	1	SETPOINT 1	-1999 to 1999
03/04, 06	2	SETPOINT 2	-1999 to 1999
NO	3	N/A	
NO	4	N/A	
03/04, 06	5	ID	0 to 9999
NO	6	N/A	
03/04, 06	7	INPUT	0 to 255
03/04, 06	8	RDGCNF	0 to 255
03/04, 06	9	ALR1CNF	0 to 255
03/04, 06	10	ALR2CNF	0 to 255
03/04, 06	11	LOOP BREAK TIME	00:00 to 99:59
03/04, 06	12	OUT1CNF	0 to 255
03/04, 06	13	OUT2CNF	0 to 255
03/04, 06	14	RAMP TIME	00:00 to 99:59
NO	15	N/A	
03/04, 06	16	COMM. PARAMETERS	0 to 255
NO	17	N/A	
03/04, 06	18	ALR1 LOW	-1999 to 9999
03/04, 06	19	ALR1 HI	-1999 to 9999
NO	20	N/A	
03/04, 06	21	ALR2 LOW	-1999 to 9999
03/04, 06	22	ALR2 HI	-1999 to 9999
03/04, 06	23	PB1/DEAD BAND 1	0 to 9999
03/04, 06	24	RESET 1	0 to 3999
03/04, 06	25	RATE 1	0 to 399.9
03/04, 06	26	CYCLE 1	1 to 199
NO	27	N/A	
03/04, 06	28	PB2/DEAD BAND 2	0 to 9999
03/04, 06	29	CYCLE 2	1 to 199
03/04, 06	30	SOAK TIME	00:00 to 99:59
03/04, 06	31	BUS FORMAT	0 to 255
03/04, 06	32	DATA FORMAT	0 to 255
03/04, 06	33	ADDRESS	0 to 199
03/04, 06	34	TRANSIT TIME	0 to 9999
NO	35	N/A	
NO	36	N/A	
NO	37	N/A	
03/04, 06	38	RECOGNITION CHAR.	32 to 126
03/04	39	PROCESS VALUE	
03/04	40	PEAK VALUE	
03/04	41	VALLEY VALUE	
03/04	42	SOFTWARE VERSION	
06	43	RESET	

6.8 Command Format

The following formats are used to SEND commands by computer and RETURNED by device.

6.8.1 Read Multiple Register (03 or 04)

SENT TO DEVICE:

DEVICE ADDRESS	FUNCTION CODE 03 or 04	DATA				CRC	
		STARTING REGISTER		NUMBER OF REGISTER			
1 BYTE nn	1 BYTE 03	HB 00	LB nn	HB 00	LB nn	LB nn	HB nn

RETURNED FROM DEVICE:

DEVICE ADDRESS	FUNCTION CODE 03 or 04	DATA					CRC		
		NUMBER OF BYTES	FIRST REGISTER		n REGISTER			
1 BYTE nn	1 BYTE 03	1 BYTE nn	HB nn	LB nn	HB nn	LB nn	LB nn	HB nn

Where: HB – High Order Byte
 LB – Lower Order Byte
 Unused bits are set to zero



iSeries devices support only Read Single Register, so the number of registers should always set to 1.

Example:

SENT TO DEVICE: Address 1, Read (03) register 1 (Setpoint 1)

DEVICE ADDRESS	FUNCTION CODE	STARTING REGISTER		NUMBER OF REGISTER		CRC	
01	03	00	01	00	01	D5	CA



To determine the appropriate registers see **Table 6.2**

RETURNED FROM DEVICE: Setpoint 1 set to 100.0

DEVICE ADDRESS	FUNCTION CODE	NUMBER OF BYTES	VALUE OF REGISTER		CRC	
01	03	02	03	E8	B8	FA

03E8 Hex = 1000 Dec

These returned data do not specify Decimal Point position. The following command will determine the Decimal Point position.

Example:

SENT TO DEVICE: Address 09, Read (03) register 08 (Reading Configuration)

DEVICE ADDRESS	FUNCTION CODE	STARTING REGISTER		NUMBER OF REGISTERS		CRC	
09	03	00	08	00	01	04	80

RETURNED FROM DEVICE:

DEVICE ADDRESS	FUNCTION CODE	NUMBER OF BYTES	VALUE OF REGISTERS		CRC	
09	03	02	00	4A	D8	72

004A Hex = 01001010 Bin. This value calls for Decimal Point position number 2 (FFF.F) – see example in 5.7.2 for Reading Configuration.

6.8.2 Write to Single Register (06)

The following command will write a parameter to the single register.

Sent to/Return from device :

DEVICE ADDRESS	FUNCTION CODE 06	DATA				CRC	
		REGISTER		DATA/VALUE			
1 BYTE nn	1 BYTE 06	HB 00	LB nn	HB nn	LB nn	LB nn	HB nn

Example: Set Alarm1 Low (register 18) to 300 Dec (12C Hex)

SEND TO DEVICE: Address 20 (14 Hex), write (06) to register 18 (12 Hex) value 300 (12C Hex)

DEVICE ADDRESS	FUNCTION CODE	REGISTER		DATA/VALUE		CRC	
14	06	00	12	01	2C	2B	47

RETURNED FROM DEVICE:

DEVICE ADDRESS	FUNCTION CODE	REGISTER		DATA/VALUE		CRC	
14	06	00	12	01	2C	2B	47

Note  iiSeries devices support only Write to Single Register command

Example: Set Alarm2 Low to –100.0 on Device address 20

We have to send two commands to accomplish this task.

First, we have to set decimal point into the position 2 (FFF.F) and then, set value of Alarm 2 Low to –1000 counts (disregard decimal point).

1. Set Decimal Point

Set the Decimal point to the position 2 (FFF.F), Temperature unit °F, Filter constant 4 - see example in 5.7.2

SEND TO DEVICE: Address 20 (Hex 14), write (06) to register 8, data 4A

DEVICE ADDRESS	FUNCTION CODE	REGISTER		DATA/ VALUE		CRC	
14	06	00	08	00	4A	8B	3A

RETURNED FROM DEVICE:

DEVICE ADDRESS	FUNCTION CODE	REGISTER		DATA/ VALUE		CRC	
14	06	00	08	00	4A	8B	3A

2. Conversion the Decimal value of (–1000) to Hexadecimal Value:

N = +1000 Dec = 0000 0011 1110 1000 Bin = 2 bytes or 16 bits

1's complement of N = 1111 1100 0001 0111 Bin = Not N

2's complement of N = 1111 1100 0001 1000 Bin = 1's complement of N + 1LSB

F C 1 8 Hex

SEND TO DEVICE: Address 20 (14 Hex), write (06) to register 21 (15 Hex) value (–1000) (FC18 Hex)

DEVICE ADDRESS	FUNCTION CODE	REGISTER		DATA/ VALUE		CRC	
14	06	00	15	FC	18	DB	C1

RETURNED FROM DEVICE:

DEVICE ADDRESS	FUNCTION CODE	REGISTER		DATA/ VALUE		CRC	
14	06	00	15	FC	18	DB	C1

Note

For examples of how to Read/Write data code for INPUT, RDGCNF, ALR1CNF, ALR2CNFG, OUT1CNF, OUT2CNF, COLOR, COMM.PARAMETERS, BUSFORMAT, DATAFORMAT see section 5.7 of this manual.

6.8.3 Diagnostic Command

This command echoes the sent message to indicate that the communication link is established correctly.

SEND TO/RETURN FROM DEVICE:

DEVICE ADDRESS	FUNCTION CODE	DIAGNOSTIC CODE		LOOPBACK DATA		CRC	
1 BYTE nn	1 BYTE 08	HB 00	LB 00	HB nn	LB nn	LB nn	HB nn

Where: Diagnostic Code is two byte code to determine the type of test to be performed. iSeries devices supported only "00" code which requested slave to echo sent command back to the master.

Example:

SEND TO DEVICE: Address 01, Diagnostic command (08), data value 8755 Dec (2233 Hex)

DEVICE ADDRESS	FUNCTION CODE	DIAGNOSTIC CODE		LOOPBACK DATA		CRC	
01	08	22	33	00	00	BE	B8

RETURNED FROM DEVICE:

DEVICE ADDRESS	FUNCTION CODE	DIAGNOSTIC CODE		LOOPBACK/ DATA		CRC	
01	08	22	33	00	00	BE	B8

6.8.4 Error Response

When a device can not properly respond to the command due to incorrect or corrupted command, it will respond with an error message. The error message has the following format:

DEVICE ADDRESS	FUNCTION CODE	ERROR RESPONSE	CRC	
1 BYTE nn	1 BYTE nn	1 BYTE nn	LB nn	HB nn

iSeries devices support the following error code messages:

- 02 – read from/write to the illegal register – read from/write to the register, which is inactive, or not supported by iSeries devices
- 03 – write an illegal value – write out of range value

Example:

SEND TO DEVICE: Address 05, read (03) register 04 - inactive (see **Table 6.2**)

DEVICE ADDRESS	FUNCTION CODE	STARTING REGISTER		NUMBER OF REGISTERS		CRC	
05	03	00	04	00	01	C4	4F

RETURNED FROM DEVICE:

DEVICE ADDRESS	FUNCTION CODE	ERROR RESPONSE	CRC	
05	83	02	81	30

Example:

SEND TO DEVICE: Address 120 (Hex 78), write (06) to register 35 (Hex 23) - inactive (see **Table 6.2**)

DEVICE ADDRESS	FUNCTION CODE	REGISTER		DATA/VALUE		CRC	
78	06	00	23	00	00	73	A9

RETURNED FROM DEVICE:

DEVICE ADDRESS	FUNCTION CODE	ERROR RESPONSE	CRC	
78	86	02	12	78

Example:

SEND TO DEVICE: Address 01, write (06) to register 12 (Hex C) value 300 (Hex 12C) -out of range (see **Table 6.2**)

DEVICE ADDRESS	FUNCTION CODE	REGISTER		DATA/VALUE		CRC	
01	06	00	0C	01	2C	49	84

RETURNED FROM DEVICE:

DEVICE ADDRESS	FUNCTION CODE	ERROR RESPONSE	CRC	
01	86	03	02	61

 **Note** When device returns an error message, it add 80 Hex to the Function Code (03 + 80 = 83 or 06 + 80 = 86)

APPENDIX A

Reading Scale and Offset for Process/Strain Gage Instrument with 10 Linearization Points (Command Indexes 2B to 33, 34 to 3C, 3D to 45)

Description: RDGOFF.23~16, 15~8, 7~0 means 3 bytes x 8 bit positions of the Reading Offset
 RDGSC.23~16, 15~8, 7~0 means 3 bytes x 8 bit positions of the Reading Scale

RDGOFF.23 =
 0 positive offset
 1 negative offset

RDGOFF.22~20 =
 DP+2

RDGOFF.19~0 =
 offset data

RDGSC.23~20 =
 DP+1

RDGSC.19 =
 0 direct scale
 1 reverse scale

RDGSC.18~0 =
 scale data

Example:

The following example assumes load cells with this specification:

Maximum Load: 100 lbs
 Output: 3.0 mV/V
 Sensor Excitation: 10 Vdc

Maximum Sensor Output = (Output) x (Sensor Excitation) = 3.0 (mV/V) x 10 (V) = 30 mV
 Input Value (**IN**) = (Sensor Output) x (Conversion Number) x (Multiplier)
 See **Tables A.1** and **A.2** below for proper Conversion and Multiplier Numbers.

Table A.1 Conversion Number

INPUT RANGE	CONVERSION NUMBER
0 ~ 100 mV	10000 / (100 x 1) = 100 cts/mV
0 ~ 1 V	10000 / (1000 x 1) = 10 cts/mV
0 ~ 10 V	10000 / (1000 x 10) = 1 cts/mV
0 ~ 20 mA	10000 / (20 x 1) = 500 cts/mA

Table A.2 Input Resolution Multiplier

INPUT RANGE	RESOLUTION	
	LOW	HIGH
0 ~ 100 mV	1.0	10.0
0 ~ 1 V	1.0	10.0
0 ~ 10 V	1.0	10.0
0 ~ 20 mA	1.0	10.0

Determine **IN min** and **IN max** Input Range and Resolution. For our transducer select 0 - 100 mV range and Low resolution.

$$\mathbf{IN\ min} = 0 \text{ (mV)} \times 100 \text{ (cts/mV)} \times 1.0 = 0$$

$$\mathbf{IN\ max} = 30 \text{ (mV)} \times 100 \text{ (cts/mV)} \times 1.0 = 3000$$

Determine correct values for Display reading (**Rd min** and **Rd max**). In most cases, Rd min and Rd max are equal to the minimum and maximum of the transducer output range.

Rd min = 0
Rd max = 100.0

We have to scale our meter to have an input 0 to 3000 (30 mV) displayed as 0 to 100.0 (lbs)

Assume that the shape of the transducer response characteristic is equal to the shape of the parabola ($Y=KX^2$)

Output = $K \times \text{Input}^2$, there $K = \text{Output} / \text{Input}^2 = 100.0 / (3000^2) = 1 / (9 \times 10^4)$

Output = $\text{Input}^2 / (9 \times 10^4)$

Let's build the response characteristic of our transducer based on the seven inputs within the range of the transducer (7 linearization points)

Input (X): In 1=0 | In 2=500 | In 3=1000 | In 4=1500 | In 5=2000 | In 6=2500 | In 7=3000

Output (Y): Rd 1=0 | Rd 2=2.8 | Rd 3=11.0 | Rd 4=25.0 | Rd 5=44.4 | Rd 6=69.4 | Rd 7=100.0

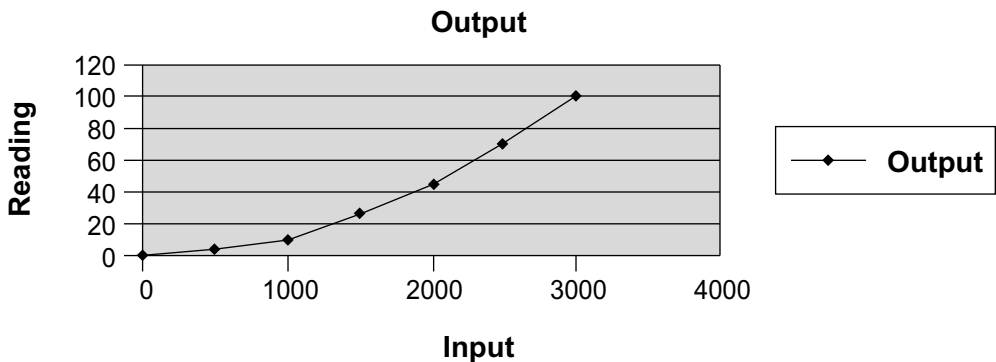

The following commands need to send to the meter to create this response characteristic.

Note First make sure that Decimal Point on your device is set to the proper position. Then, disregard the decimal point position through Scale and Offset calculation. For instance: to display 0 to 100 set decimal point into position 1 (**FFFF**); to display 0 to 100.0 set decimal point into position 2 (**FFF.F**) then, perform Scale and Offset calculation to display 0 to 1000.

1. The command for number of linearization points is **29 (Table 5.4)** and the data has offset -2. Send command: *W2905 means 7 point of linearization are active.

2. Out of ten points the very first one is not available through the communication commands. The nine points from 1st to 9th must represent min and max of each interval respectively, and the points in between them must progressively incrementing. The commands for these points are **2B to 33 (Table 5.4)**

2.1 Send command: *W2B2001F4 means 5 mV input for Scale 1/Offset 1 is active, DP=2

2.2 Send command: *W2C2003E8 means 10 mV input for Scale 2/Offset 2 is active, DP=2

2.3 Send command: *W2D2005DC means 15 mV input for Scale 3/Offset 3 is active, DP=2

2.4 Send command: *W2E2007D0 means 20 mV input for Scale 4/Offset 4 is active, DP=2

2.5 Send command: *W2F2009C4 means 25 mV input for Scale 5/Offset 5 is active, DP=2

2.6 Send command: *W30200BB8 means 30 mV input for Scale 6/Offset 6 is active, DP=2

3. Calculate Scale.

$$\text{Scale} = \frac{\text{Rd}(n) - \text{Rd}(n-1)}{\text{IN}(n) - \text{IN}(n-1)}, \text{ where } n \text{ is an interger}$$

The commands for these points are **34 to 3C (Table 5.4)**

3.1 Scale 1 = (28 - 0) / (500 - 0) = 56000 x E-6
56000 Dec = DAC0 Hex is a Reading Scale Data (RDGSC1.18~0 = DAC0)
E-6 represented as RDGSC1.23~20 = 7 (DP+1=7)
RDGSC1.19 = 0 (direct scale)
Send command: *W3470DAC0

3.2 Scale 2 = (110 - 28) / (1000 - 500) = 164000 x E-6
RDGSC2.18~0 = 164000 Dec = 280A0 Hex
RDGSC2.23~20 = 7
RDGSC2.19~0 = 0
Send command: *W357280A0

3.3 Scale 3 = (250 - 110) / (1500 - 1000) = 280000 x E-6
RDGSC3.18~0 = 280000 Dec = 445C0 Hex
RDGSC3.23~20 = 7
RDGSC3.19~0 = 0
Send command: *W367445C0

- 3.4 Scale 4 = $(444 - 250) / (2000 - 1500) = 388000 \times E-6$
 RDGSC4.18~0 = 388000 Dec = 5EBA0 Hex
 RDGSC4.23~20 = 7
 RDGSC4.19~0 = 0
 Send command: *W3775EBA0
- 3.5 Scale 5 = $(694 - 444) / (2500 - 2000) = 500000 \times E-6$
 RDGSC5.18~0 = 500000 Dec = 7A120 Hex
 RDGSC5.23~20 = 7
 RDGSC5.19~0 = 0
 Send command: *W3877A120
- 3.6 Scale 6 = $(1000 - 694) / (3000 - 2500) = 612000 \times E-6$
 RDGSC6.18~0 = 612000 Dec = 956A0 Hex
 RDGSC6.23~20 = 7
 RDGSC6.19~0 = 0
 Send command: *W397956A0

4. Calculate Offset.

Reading = Scale x Input + Offset

Offset (n) = Reading (n) - Scale (n) x Input (n), where n is an integer

The commands for these points are **3D** to **45** (Table 5.4)

- 4.1 Offset 1 = $28 - (28 - 0) / (500 - 0) \times 500 = 0$
 RDGOFF1.19~0 = 0 Dec = 0 Hex
 RDGOFF1.22~20 = 2 (DP+2)
 RDGOFF1.23 = 1 (Offset is negative)
 Send command: *W3DA00000
- 4.2 Offset 2 = $110 - (110 - 28) / (1000 - 500) \times 1000 = -54 \times E0$
 RDGOFF2.19~0 = 54 Dec = 36 Hex
 RDGOFF2.22~20 = 2 (DP+2)
 RDGOFF2.23 = 1 (Offset is negative)
 Send command: *W3EA00036
- 4.3 Offset 3 = $250 - (250 - 110) / (1500 - 1000) \times 1500 = -170 \times E0$
 RDGOFF3.19~0 = 170 Dec = AA Hex
 RDGOFF3.22~20 = 2 (DP+2)
 RDGOFF3.23 = 1 (Offset is negative)
 Send command: *W3FA000AA
- 4.4 Offset 4 = $444 - (444 - 250) / (2000 - 1500) \times 2000 = -332$
 RDGOFF4.19~0 = 332 Dec = 14C Hex
 RDGOFF4.22~20 = 2 (DP+2)
 RDGOFF4.23 = 1 (Offset is negative)
 Send command: *W40A0014C

4.5 Offset 5 = $694 - (694 - 444) / (2500 - 2000) \times 2500 = -556$
RDGOFF5.19~0 = 556 Dec = 22C Hex
RDGOFF5.22~20 = 2 (DP+2)
RDGOFF5.23 = 1 (Offset is negative)
Send command: *W41A0022C

4.6 Offset 6 = $1000 - (1000 - 694) / (3000 - 2500) \times 3000 = -836$
RDGOFF6.19~0 = 836 Dec = 344 Hex
RDGOFF6.22~20 = 2 (DP+2)
RDGOFF6.23 = 1 (Offset is negative)
Send command: *W42A00344

 **Note** Hard reset command (*Z02) should be sent at the end in order to load changes into Volatile memory.

APPENDIX B

ASCII Chart

ASCII Char	Dec	Hex	Binary No parity	ASCII Char	Dec	Hex	Binary No Parity
NUL	00	00	00000000	@	64	40	01000000
SOH	01	01	00000001	A	65	41	01000000
STX	02	02	00000010	B	66	42	01000010
ETX	03	03	00000011	C	67	43	01000011
EOT	04	04	00000100	D	68	44	01000100
ENQ	05	05	00000101	E	69	45	01000101
ACK	06	06	00000110	F	70	46	01000110
BEL	07	07	00000111	G	71	47	01000111
BS	08	08	00001000	H	72	48	01001000
HT	09	09	00001001	I	73	49	01001001
LF	10	0A	00001010	J	74	4A	01001010
VT	11	0B	00001011	K	75	4B	01001011
FF	12	0C	00001100	L	76	4C	01001100
CR	13	0D	00001101	M	77	4D	01001101
SO	14	0E	00001110	N	78	4E	01001110
SI	15	0F	00001111	O	79	4F	01001111
DLE	16	10	00010000	P	80	50	01010000
DC1	17	11	00010001	Q	81	51	01010001
DC2	18	12	00010010	R	82	52	01010010
DC3	19	13	00010011	S	83	53	01010011
DC4	20	14	00010100	T	84	54	01010100
NAK	21	15	00010101	U	85	55	01010101
SYN	22	16	00010110	V	86	56	01010110
ETB	23	17	00010111	W	87	57	01010111
CAN	24	18	00011000	X	88	58	01011000
EM	25	19	00011001	Y	89	59	01011001
SUB	26	1A	00011010	Z	90	5A	01011010
ESC	27	1B	00011011	[91	5B	01011011
FS	28	1C	00011100	\	92	5C	01011100
GS	29	1D	00011101]	93	5D	01011101
RS	30	1E	00011110	^	94	5E	01011110
US	31	1F	00011111	_	95	5F	01011111
SP	32	20	00100000	`	96	60	01100000
!	33	21	00100001	a	97	61	01100001
"	34	22	00100010	b	98	62	01100010
#	35	23	00100011	c	99	63	01100011
\$	36	24	00100100	d	100	64	01100100
%	37	25	00100101	e	101	65	01100101
&	38	26	00100110	f	102	66	01100110
	39	27	00100111	g	103	67	01100111
(40	28	00101000	h	104	68	01101000
)	41	29	00101001	i	105	69	01101001
*	42	2A	00101010	j	106	6A	01101010
+	43	2B	00101011	k	107	6B	01101011
	44	2C	00101100	l	108	6C	01101100
-	45	2D	00101101	m	109	6D	01101101
	46	2E	00101110	n	110	6E	01101110

ASCII Chart Continued

ASCII Char	Dec	Hex	Binary No parity	ASCII Char	Dec	Hex	Binary No Parity
/	47	2F	00101111	o	111	6F	01101111
0	48	30	00110000	p	112	70	01110000
1	49	31	00110001	q	113	71	01110001
2	50	32	00110010	r	114	72	01110010
3	51	33	00110011	s	115	73	01110011
4	52	34	00110100	t	116	74	01110100
5	53	35	00110101	u	117	75	01110101
6	54	36	00110110	v	118	76	01110110
7	55	37	00110111	w	119	77	01110111
8	56	38	00111000	x	120	78	01111000
9	57	39	00111001	y	121	79	01111001
:	58	3A	00111010	z	122	7A	01111010
;	59	3B	00111011	{	123	7B	01111011
<	60	3C	00111100		124	7C	01111100
=	61	3D	00111101	}	125	7D	01111101
>	62	3E	00111110	~	126	7E	01111110
?	63	3F	00111111	DEL	127	7F	01111111

ASCII Control Codes

ASCII Char	Dec	Hex	Ctrl Key Equiv.	Definition	ASCII Char	Dec	Hex	Ctrl Key Equiv.	Definition
NUL	00	00	Ctrl @	Null Character	DC1	17	11	Ctrl Q	Data Control 1 - XON
SOH	01	01	Ctrl A	Start of Header	DC2	18	12	Ctrl R	Data Control 2
STX	02	02	Ctrl B	Start of Text	DC3	19	13	Ctrl S	Data Control 3 - XOFF
ETX	03	03	Ctrl C	End of Text	DC4	20	14	Ctrl T	Data Control 4
EOT	04	04	Ctrl D	End of Transmission	NAK	21	15	Ctrl U	Negative Acknowledge
ENQ	05	05	Ctrl E	Inquiry	SYN	22	16	Ctrl V	Synchronous Idle
ACK	06	06	Ctrl F	Acknowledge	ETB	23	17	Ctrl W	End of Trans Block
BEL	07	07	Ctrl G	Bell	CAN	24	18	Ctrl X	Cancel
BS	08	08	Ctrl H	Back Space	EM	25	19	Ctrl Y	End of Medium
HT	09	09	Ctrl I	Horizontal Tabulation	SUB	26	1A	Ctrl Z	Substitute
LF	10	0A	Ctrl J	Line Feed	ESC	27	1B	Ctrl [Escape
VT	11	0B	Ctrl K	Vertical Tabulation	FS	28	1C	Ctrl \	File Separator
FF	12	0C	Ctrl L	Form Feed	GS	29	1D	Ctrl]	Group Separator
CR	13	0D	Ctrl M	Carriage Return	RS	30	1E	Ctrl ^	Record Separator
SO	14	0E	Ctrl N	Shift Out	US	31	1F	Ctrl _	Unit Separator
SI	15	0F	Ctrl O	Shift In	SP	32	20		Space
DLE	16	10	Ctrl P	Data Link Escape					

APPENDIX C

Example of CRC Calculation

Device address 06, read (03), starting register 0008, number of registers 0001

CRC Calculation

Function code	Two byte (16 bit) Register				Overflow Bit
	HB		LB		
Load 16 bit register to all 1's	1111	1111	1111	1111	0
First byte is address 06			0000	0110	
Exclusive OR	1111	1111	1111	1001	
1st shift	0111	1111	1111	1100	1
A001	1010	0000	0000	0001	
Exclusive OR	1101	1111	1111	1101	
2nd shift	0110	1111	1111	1110	1
A001	1010	0000	0000	0001	
Exclusive OR	1100	1111	1111	1111	
3rd shift	0110	0111	1111	1111	1
A001	1010	0000	0000	0001	
Exclusive OR	1100	0111	1111	1110	
4th shift	0110	0011	1111	1111	0
5th shift	0011	0001	1111	1111	1
A001	1010	0000	0000	0001	
Exclusive OR	1001	0001	1111	1110	
6th shift	0100	1000	1111	1111	0
7th shift	0010	0100	0111	1111	1
A001	1010	0000	0000	0001	
Exclusive OR	1000	0100	0111	1110	
8th shift	0100	0010	0011	1111	0
Second byte Read 03			0000	0011	
Exclusive OR	0100	0010	0011	1100	
1st shift	0010	0001	0001	1110	0
2nd shift	0001	0000	1000	1111	0
3rd shift	0000	1000	0100	0111	1
A001	1010	0000	0000	0001	
Exclusive OR	1010	1000	0100	0110	
4th shift	0101	0100	0010	0011	0
5th shift	0010	1010	0001	0001	1
A001	1010	0000	0000	0001	
Exclusive OR	1000	1010	0001	0000	
6th shift	0100	0101	0000	1000	0
7th shift	0010	0010	1000	0100	0
8th shift	0001	0001	0100	0010	0
Third byte Starting reg. 00			0000	0000	
Exclusive OR	0001	0001	0100	0010	
1st shift	0000	1000	1010	0001	0
2nd shift	0000	0100	0101	0000	1
A001	1010	0000	0000	0001	
Exclusive OR	1010	0100	0101	0001	
3rd shift	0101	0010	0010	1000	1
A001	1010	0000	0000	0001	
Exclusive OR	1111	0010	0010	1001	
4th shift	0111	1001	0001	0100	1

CRC Calculation Continued

Function code	Two byte (16 bit) Register				Overflow Bit
	HB		LB		
A001	1010	0000	0000	0001	
Exclusive OR	1101	1001	0001	0101	
5th shift	0110	1100	1000	1010	1
A001	1010	0000	0000	0001	
Exclusive OR	1100	1100	1000	1011	
6th shift	0110	0110	0100	0101	1
A001	1010	0000	0000	0001	
Exclusive OR	1100	0110	0100	0100	
7th shift	0110	0011	0010	0010	0
8th shift	0011	0001	1001	0001	0
Fourth Byte 08			0000	1000	
Exclusive OR	0011	0001	1001	1001	
1st shift	0001	1000	1100	1100	1
A001	1010	0000	0000	0001	
Exclusive OR	1011	1000	1100	1101	
2nd shift	0101	1100	0110	0110	1
A001	1010	0000	0000	0001	
Exclusive OR	1111	1100	0110	0111	
3rd shift	0111	1110	0011	0011	1
A001	1010	0000	0000	0001	
Exclusive OR	1101	1110	0011	0010	
4th shift	0110	1111	0001	1001	0
5th shift	0011	0111	1000	1100	1
A001	1010	0000	0000	0001	
Exclusive OR	1001	0111	1000	1101	
6th shift	0100	1011	1100	0110	1
A001	1010	0000	0000	0001	
Exclusive OR	1110	1011	1100	0111	
7th shift	0111	0101	1110	0011	1
A001	1010	0000	0000	0001	
Exclusive OR	1101	0101	1110	0010	
8th shift	0110	1010	1111	0001	0
Fifth Byte 00			0000	0000	
Exclusive OR	0110	1010	1111	0001	
1st shift	0011	0101	0111	1000	1
A001	1010	0000	0000	0001	
Exclusive OR	1001	0101	0111	1001	
2nd shift	0100	1010	1011	1100	1
A001	1010	0000	0000	0001	
Exclusive OR	1110	1010	1011	1101	
3rd shift	0111	0101	0101	1110	1
A001	1010	0000	0000	0001	
Exclusive OR	1101	0101	0101	1111	
4th shift	0110	1010	1010	1111	1
A001	1010	0000	0000	0001	
Exclusive OR	1100	1010	1010	1110	
5th shift	0110	0101	0101	0111	0
6th shift	0011	0010	1010	1011	1

CRC Calculation Continued

Function code	Two byte (16 bit) Register				Overflow Bit
	HB		LB		
A001	1010	0000	0000	0001	
Exclusive OR	1001	0010	1010	1010	
7th shift	0100	1001	0101	0101	0
8th shift	0010	0100	1010	1010	1
A001	1010	0000	0000	0001	
Exclusive OR	1000	0100	1010	1011	
Sixth Byte 01			0000	0001	
Exclusive OR	1000	0100	1010	1010	
1st shift	0100	0010	0101	0101	0
2nd shift	0010	0001	0010	1010	1
A001	1010	0000	0000	0001	
Exclusive OR	1000	0001	0010	1011	
3rd shift	0100	0000	1001	0101	1
A001	1010	0000	0000	0001	
Exclusive OR	1110	0000	1001	0100	
4th shift	0111	0000	0100	1010	0
5th shift	0011	1000	0010	0101	0
6th shift	0001	1100	0001	0010	1
A001	1010	0000	0000	0001	
Exclusive OR	1011	1100	0001	0011	
7th shift	0101	1110	0000	1001	1
A001	1010	0000	0000	0001	
Exclusive OR	1111	1110	0000	1000	
8th shift	0111	1111	0000	0100	0
CRC code	7	F	0	4	

Transmitted Message:

DEVICE ADDRESS	FUNCTION CODE	STARTING REGISTER		NUMBER OF REGISTERS		CRC	
		00	08	00	01	04	7F
06	03	00	08	00	01	04	7F

Example of CRC calculation in “C” language

This subroutine used to do CRC calculation

```
#define POLY 0xA001;

unsigned int crc_calculation (unsigned char *start_string, unsigned char number_byte)
{
    unsigned int crc;
    unsigned char bit_counter;
    unsigned char *data_pointer;

    data_pointer= start_string;
    crc = 0xffff;           // Initialize crc

    while (number_byte>0)
    {
        crc ^= data_pointer // crc XOR with data
        bit_counter=0;     // reset counter

        while (bit_counter < 8)
        {
            if (crc & 0x0001)
            {
                crc >>= 1; // shift to the right 1 position
                crc ^= POLY; // crc XOR with POLY
            }

            else
            {
                crc >>=1; // shift to the right 1 position
            }

            bit_counter++; // increase counter
        }

        number_byte--; // adjust byte counter
    }
    return (crc); // final result of crc
}
```



WARRANTY/DISCLAIMER

OMEGA ENGINEERING, INC. warrants this unit to be free of defects in materials and workmanship for a period of **one (1) year** from the date of purchase. In addition to OMEGA's standard warranty period, OMEGA Engineering will extend the warranty period for **four (4) additional years** if the warranty card enclosed with each instrument is returned to OMEGA.

If the unit malfunctions, it must be returned to the factory for evaluation. OMEGA's Customer Service Department will issue an Authorized Return (AR) number immediately upon phone or written request. Upon examination by OMEGA, if the unit is found to be defective, it will be repaired or replaced at no charge. OMEGA's WARRANTY does not apply to defects resulting from any action of the purchaser, including but not limited to mishandling, improper interfacing, operation outside of design limits, improper repair, or unauthorized modification. This WARRANTY is VOID if the unit shows evidence of having been tampered with or shows evidence of having been damaged as a result of excessive corrosion; or current, heat, moisture or vibration; improper specification; misapplication; misuse or other operating conditions outside of OMEGA's control. Components which wear are not warranted, including but not limited to contact points, fuses, and triacs.

OMEGA is pleased to offer suggestions on the use of its various products. However, OMEGA neither assumes responsibility for any omissions or errors nor assumes liability for any damages that result from the use of its products in accordance with information provided by OMEGA, either verbal or written. OMEGA warrants only that the parts manufactured by it will be as specified and free of defects. OMEGA MAKES NO OTHER WARRANTIES OR REPRESENTATIONS OF ANY KIND WHATSOEVER, EXPRESS OR IMPLIED, EXCEPT THAT OF TITLE, AND ALL IMPLIED WARRANTIES INCLUDING ANY WARRANTY OF MERCHANTABILITY AND FITNESS FOR A PARTICULAR PURPOSE ARE HEREBY DISCLAIMED. LIMITATION OF LIABILITY: The remedies of purchaser set forth herein are exclusive, and the total liability of OMEGA with respect to this order, whether based on contract, warranty, negligence, indemnification, strict liability or otherwise, shall not exceed the purchase price of the component upon which liability is based. In no event shall OMEGA be liable for consequential, incidental or special damages.

CONDITIONS: Equipment sold by OMEGA is not intended to be used, nor shall it be used: (1) as a "Basic Component" under 10 CFR 21 (NRC), used in or with any nuclear installation or activity; or (2) in medical applications or used on humans. Should any Product(s) be used in or with any nuclear installation or activity, medical application, used on humans, or misused in any way, OMEGA assumes no responsibility as set forth in our basic WARRANTY/DISCLAIMER language, and, additionally, purchaser will indemnify OMEGA and hold OMEGA harmless from any liability or damage whatsoever arising out of the use of the Product(s) in such a manner.

RETURN REQUESTS/INQUIRIES

Direct all warranty and repair requests/inquiries to the OMEGA Customer Service Department. **BEFORE RETURNING ANY PRODUCT(S) TO OMEGA, PURCHASER MUST OBTAIN AN AUTHORIZED RETURN (AR) NUMBER FROM OMEGA'S CUSTOMER SERVICE DEPARTMENT (IN ORDER TO AVOID PROCESSING DELAYS).** The assigned AR number should then be marked on the outside of the return package and on any correspondence.

The purchaser is responsible for shipping charges, freight, insurance and proper packaging to prevent breakage in transit.

FOR WARRANTY RETURNS, please have the following information available **BEFORE** contacting OMEGA:

1. Purchase Order number under which the product was PURCHASED,
2. Model and serial number of the product under warranty, and
3. Repair instructions and/or specific problems relative to the product.

FOR NON-WARRANTY REPAIRS, consult OMEGA for current repair charges. Have the following information available **BEFORE** contacting OMEGA:

1. Purchase Order number to cover the COST of the repair,
2. Model and serial number of product, and
3. Repair instructions and/or specific problems relative to the product.

OMEGA's policy is to make running changes, not model changes, whenever an improvement is possible. This affords our customers the latest in technology and engineering.

© Copyright 2007 OMEGA ENGINEERING, INC. All rights reserved. This document may not be copied, photocopied, reproduced, translated, or reduced to any electronic medium or machine-readable form, in whole or in part, without the prior written consent of OMEGA ENGINEERING, INC.

TRADEMARK NOTICE: ®, ®,  **OMEGA**®, and  are Trademarks of OMEGA ENGINEERING, INC.

PATENT NOTICE: This product is covered by one or more of the following patents: U.S. Pat. No. Des. 336,895; 5,274,577; 6,243,021 / CANADA 2052599; 2052600 / ITALY 1249456; 1250938 / FRANCE BREVET No. 91 12756 / SPAIN 2039150; 2048066 / UK PATENT No. GB2 249 837; GB2 248 954 / GERMANY DE 41 34398 C2. The "Meter Bezel Design" is a Trademark of NEWPORT Electronics, Inc. Used under License. Other US and International Patents pending or applied for.

Where Do I Find Everything I Need for Process Measurement and Control? **OMEGA...Of Course!** *Shop on line at omega.com*

TEMPERATURE

- Thermocouple, RTD & Thermistor Probes, Connectors, Panels & Assemblies
- Wire: Thermocouple, RTD & Thermistor
- Calibrators & Ice Point References
- Recorders, Controllers & Process Monitors
- Infrared Pyrometers

PRESSURE, STRAIN AND FORCE

- Transducers & Strain Gauges
- Load Cells & Pressure Gauges
- Displacement Transducers
- Instrumentation & Accessories

FLOW/LEVEL

- Rotameters, Gas Mass Flowmeters & Flow Computers
- Air Velocity Indicators
- Turbine/Paddlewheel Systems
- Totalizers & Batch Controllers

pH/CONDUCTIVITY

- pH Electrodes, Testers & Accessories
- Benchtop/Laboratory Meters
- Controllers, Calibrators, Simulators & Pumps
- Industrial pH & Conductivity Equipment

DATA ACQUISITION

- Data Acquisition & Engineering Software
- Communications-Based Acquisition Systems
- Plug-in Cards for Apple, IBM & Compatibles
- Datalogging Systems
- Recorders, Printers & Plotters

HEATERS

- Heating Cable
- Cartridge & Strip Heaters
- Immersion & Band Heaters
- Flexible Heaters
- Laboratory Heaters

ENVIRONMENTAL MONITORING AND CONTROL

- Metering & Control Instrumentation
- Refractometers
- Pumps & Tubing
- Air, Soil & Water Monitors
- Industrial Water & Wastewater Treatment
- pH, Conductivity & Dissolved Oxygen Instruments